

WLC series balances

WLC precision balances
WLC C/2 precision balances

USER MANUAL

ITKU-22-06-06-16-EN



 **RADWAG BALANCES AND SCALES**
ADVANCED WEIGHING TECHNOLOGIES

JUNE 2016

TABLE OF CONTENTS

1. INTENDED USE	5
2. PRECAUTIONS	6
2.1. Maintenance	6
2.2. Accumulator / battery pack	6
2.2.1. Power supply of scales WLC/F1, WLC/C2	7
2.2.2. Replacement of worn batteries	7
2.3. Operation in a strong electrostatic field	8
2.4. Maintenance activities	8
3. WARRANTY CONDITIONS	10
4. MAIN DIMENSIONS	11
5. UNPACKING AND ASSEMBLY	14
6. UNDER-PAN WEIGHING	15
7. GETTING STARTED	17
8. BALANCE LEVELLING	17
9. KEYPAD	18
10. KEYS' FUNCTIONS	19
11. INSCRIPTIONS ON THE DISPLAY	19
12. USER MENU	21
12.1. Submenus	21
12.2. Browsing user menu	22
12.2.1. Keypad	22
12.2.2. Return to the weighing mode	22
13. WEIGHING	23
13.1. Tarring	24
13.2. Inscribing tare value	24
13.3. Zeroing	25
13.4. Weighings in two ranges	25
13.5. Selection of basic weight unit	26
13.6. Temporarily selected unit	27
14. MAIN PARAMETERS	28
14.1. Setting a filtering level	28
14.2. Median filter	29
14.3. Autozero function	30
14.4. Tare function	31
15. RS 232 PARAMETERS	32
15.1. Printout type	32
15.2. Minimal mass threshold	33
15.3. Baud rate	34
15.4. Serial transmission parameters	35
16. OTHER PARAMETERS	36
16.1. Backlight function	36
16.1.1. Backlight for supplying from mains	36
16.1.2. Backlight for supplying from batteries	37
16.2. "Beep" signal – after pressing a key	38
16.3. Automatic switch-off	38
16.4. Battery voltage level check	39
16.4.1. Checking the batteries	39
16.4.2. Battery discharge pictogram	40
16.4.3. Accumulator charging option	40
16.4.4. Formatting rechargeable battery packs	41
17. OPERATION MODES	42
17.1. Setting accessibility of operation modes	42
17.2. Selecting quantity of operation modes	43
17.3. Counting pieces of the same mass	44
17.4. +/- control referring to the inscribed standard mass	46
17.5. Control of % deviation referring to the inscribed standard mass	48
17.5.1. Standard mass determined by its weighing	48
17.5.2. Mass of standard inscribed to scale memory	49

17.6. Automatic tare.....	50
17.7. Measurement of maximal force on the pan – latch.....	51
17.8. Totalizing	51
17.8.1. Enabling the work mode	52
17.8.2. Totalizing procedure	52
17.8.3. Memory of the last value of sum of weighed goods.....	53
17.8.4. Return to weighing.....	54
17.9. Weighing animals	55
17.10. Tare memory.....	56
17.10.1. Entering the tare value to the scale memory.....	56
17.10.2. Selecting a tare value from the memory.....	58
18. SCALE CALIBRATION.....	59
18.1. Internal calibration	59
18.1.1. Manual internal calibration	60
18.1.2. Automatic internal calibration.....	61
18.1.3. A report from calibration.....	64
18.2. External calibration	65
18.3. Start mass adjustment.....	66
19. COOPERATION WITH PRINTER.....	68
20. COOPERATION WITH COMPUTER.....	69
21. COMMUNICATION PROTOCOL.....	70
21.1. General information	70
21.2. A set of commands for RS interfaces	70
21.3. Respond message format	71
21.4. Command's description	71
21.4.1. Zeroing.....	71
21.4.2. Tarring.....	72
21.4.3. Get tare value	72
21.4.4. Set tare value.....	72
21.4.5. Send the stable result in basic unit.....	73
21.4.6. Send the result immediately in basic unit	73
21.4.7. Send the stable result in current unit	74
21.4.8. Send the result immediately in current unit.....	74
21.4.9. Switch on continuous transmission in basic unit.....	75
21.4.10. Switch off continuous transmission in basic unit	75
21.4.11. Switch on continuous transmission in current unit	76
21.4.12. Switch off continuous transmission in current unit	76
21.4.13. Lock the scale keyboard.....	76
21.4.14. Unlock the scale keyboard	77
21.4.15. Give serial number	77
21.4.16. Send all implemented commands	77
21.5. Manual printouts / automatic printouts.....	77
21.6. Continuous transmission	78
21.7. Configuring printouts.....	79
22. ERROR COMMANDS.....	80
23. TECHNICAL PARAMETERS	81
23.1. Precisions scales of WLC series	81
23.2. Precise scales of WLC.../C/2 series	83
24. TROUBLE SHOOTING.....	83
25. ADDITIONAL EQUIPMENT.....	84

1. INTENDED USE

Scales are designed for fast and precise measurements of weighed loads masses and direct commercial settlements. Tarring in full weighing range enables to determine net mass of weighed loads. Additional display is additional equipment of scale.

Functions:

- backlight of display
- level of filtration
- autozero function
- setting baud rate of transmission
- continuous data transmission for RS 232
- automatic operation for RS 232
- designed printouts
- designation minimum mass for function operating
- counting pieces
- +/- mass control
- percentage deviation from standard mass
- latch of maximum scale indication
- automatic tare
- memory of tare
- inscribing tare value
- Memory of 9 tare values
- automatic scale switch-off
- user calibration
- internal calibration
- Totalizing
- Weighing animals

User functions may have attribute of accessibility. For this reason it is possible to adjust scale to individual needs to provide access to only these functions which are currently needed. Attribute determination accessible / inaccessible is possible in user menu and described in further part of manual.

2. PRECAUTIONS

2.1. Maintenance

- A. Please, read carefully this user manual before and use the device according to its intended use.
- B. Devices that are to be withdrawn from use age should be sent back to the producer or in case of own utilization do it according to the law.

2.2. Accumulator / battery pack

The device connected to mains intelligently monitors the battery state and charges it if possible. After sudden lack of power supply from the mains the device automatically switches to accumulator without breaking operation.

- **WLC/F1, WLC/C2** scales are devices designed to be supplied from **NiMH** batteries (nickel-metal-hydrogen) with rated voltage of **1.2V**, size **R6** and capacities from **1800** to **2800mAh** charged while connected to mains without stopping operation.
- **WLC A1...A2, WLC C/2** scales are devices designed to be supplied from **SLA** accumulators (*Sealed lead acid type*) **6V** and capacity **3** to **4Ah** charged while connected to mains without stopping operation.



In case of an elongated storage period in low temperatures, it is not allowed the full discharge of the accompanied batteries.



The equipment including accumulators does not belong to your regular household waste. The European legislation requires that electric and electronic equipment be collected and disposed separately from other communal waste with the aim of being recycled.

Caution:

Some symbols on accumulators identify harmful elements/compounds:

Pb = lead,

Cd = cadmium,

Hg = mercury.

2.2.1. Power supply of scales WLC/F1, WLC/C2

WLC/F1, WLC/C2 scales are intended to be supplied from a power adapter or from NiMH rechargeable battery pack (standard equipment). New rechargeable batteries should be formatted according to the description in the chapter 16.4.4. of this manual.

Alternatively, you can use to power the device R6 size standard non-rechargeable batteries. If you want to use normal batteries instead of rechargeable ones, proceed as follows:

- Before installing non-rechargeable batteries turn on the device and set **<5.5.Chr6>** to **<no>**, to switch off charging.
- Then install the batteries.



Installing batteries without changing <5.5.Chr6> to <no> may cause damage of batteries and the indicator.

2.2.2. Replacement of worn batteries

Users of scales **WLC/F1, WLC/C2** can exchange worn out accumulators to new ones.

Procedure:

- Open the lid of the chamber for batteries placed in the bottom of the indicator casing:
- Remove discharged and then insert new batteries into the chamber, according to given polarity (+/-):

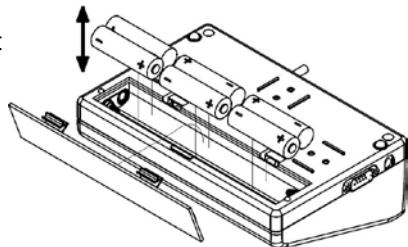
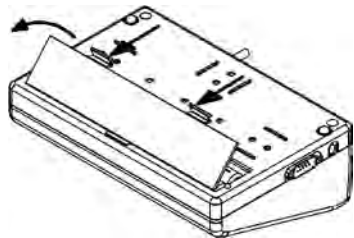

- Close the lid of the chamber for batteries:

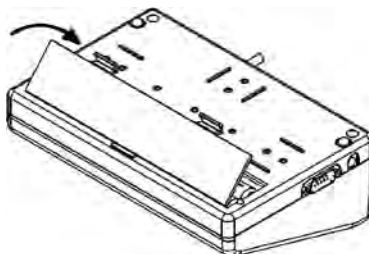

In WLC A1...A2, WLC C/2 scales the worn out accumulator can be exchanged to a new one by the authorized service of the manufacturer.

2.3. Operation in a strong electrostatic field

If the device is about to operate in a strong electrostatic field (e.g. printing houses etc.) it should be connected to the earthing.

Connect it to the clamp terminal signed \perp .

2.4. Maintenance activities

It is necessary to uninstall the weighing pan and other detachable components prior cleaning the balance, this guarantees safety. The components differ depending on balance/scale model (read description in section: UNPACKING AND ASSEMBLY).

Caution:

Cleaning draft shield while still installed may cause damage of the measuring system.

Cleaning ABS components

To clean dry surfaces and avoid smutching use clean non-colouring cloths made of cellulose or cotton. You can use a solution of water and detergent (soap, dishwashing detergent, glass cleaner). Gently rub the cleaned surface and let it dry. Repeat cleaning process if needed.

In the case when contamination is hard to remove, e.g. adhesive, rubber, resin, polyurethane foam residues etc., you can use a special cleaning agents based on a mixture of aliphatic hydrocarbons that do not dissolve plastics. Before using the cleanser for all surfaces we recommend carrying out tests. Do not use products containing abrasive substances.

Cleaning draft shield panes

Select dissolvent depending on a dirt. Never soak the glass panes in alkaline solutions since they interact with glass and may cause damage. Do not use abrasive substances.

For organic dirt use acetone first, next use water or detergent. For other than organic dirt use diluted acid solutions (soluble salts of hydrochloric or nitric acid) or base solutions (ammonium or sodium base).

To remove ACIDS use protofilic solvent (sodium carbonate), to remove BASE use protogenic solvent (mineral acid of various concentration).

In case of heavy contamination use brush or detergent nevertheless avoid detergents containing large and hard molecules which could potentially scratch glass panes.

Use soft brush with wooden or plastic handle exclusively to avoid risk of scratches. Do not use wire brush.

At the end of the cleaning process rinse the pane using running water first, distilled next.

Rinsing is a necessary cleaning process stage allowing to remove remaining soap, detergents and other cleansers from the panes prior their reinstallation.

Avoid drying the panes either using paper towel or forced air circulation since some fibres, grains or contamination of other type could permeate into the panes thus causing weighing errors.

One shall not use driers when drying measuring glass tools.

It is a frequent treatment to leave glass components on a rack to dry.

Cleaning stainless steel components

Avoid using cleansers containing any corrosive chemicals, e.g. bleach (containing chlorine). Do not use abrasive substances. Always remove the dirt using microfiber cloth to avoid damage of protective coating.

In case of a daily maintenance:

1. Remove the dirt using cloth dipped in warm water.
2. For best results, add a little dishwashing detergent.

Cleaning powder-coated components

For preliminary cleaning stage you need running water or wet sponge featuring large wholes, this will help you to remove loose, heavy dirt.

Do not use cleansers containing abrasive substances.

Next using cloth and cleanser-water solution (soap, dishwashing liquid) gently rub the cleaned surface.

Avoid using cleanser without water since it may result with damage of the cleaned surface, please mind that large amount of water mixed with cleanser is a must.

Cleaning aluminium components

While cleaning aluminium components use products acid by nature, e.g. spirit vinegar, lemon. Do not use abrasive substances. Avoid using hard brush, this may cause scratches. It is recommended to use microfibre cloth.

While polishing the surface use circular movements. Use clean, dry cloth.

3. WARRANTY CONDITIONS

- A. RADWAG is obliged to repair or change those elements that appears to be faulty because of production and construction reason,
- B. Defining defects of unclear origin and outlining methods of elimination can be settled only in participation of a user and the manufacturer representatives,
- C. RADWAG does not take any responsibility connected with destructions or losses derives from non-authorized or inappropriate (not adequate to manuals) production or service procedures,

- D. Warranty does not cover:
- Mechanical failures caused by inappropriate maintenance of the device or failures of thermal or chemical origin or caused by atmospheric discharge, over voltage in mains or other random event,
 - Inappropriate cleaning.
- E. Loss of warranty appears after:
- Access by an unauthorized service,
 - Intrusion into mechanical or electronic construction of, unauthorized people,
 - Removing or destroying protection stickers.
- F. Warranty conditions outline the warranty period for rechargeable batteries attached to the device for 12 months.
- G. The detailed warranty conditions one can find in warranty certificate.
- H. Contact with the central authorized service:
+48 48 384 88 00 ext. 106 or 107.

4. MAIN DIMENSIONS

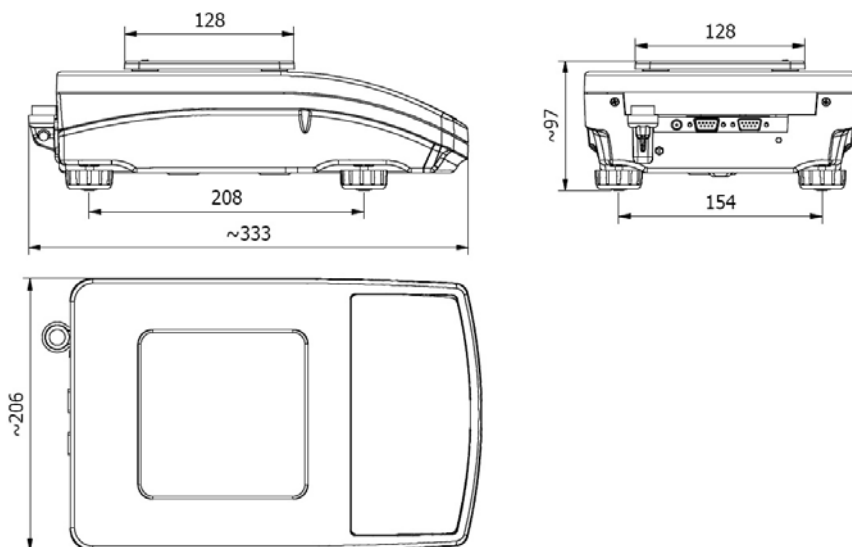

Scales WLC/A1

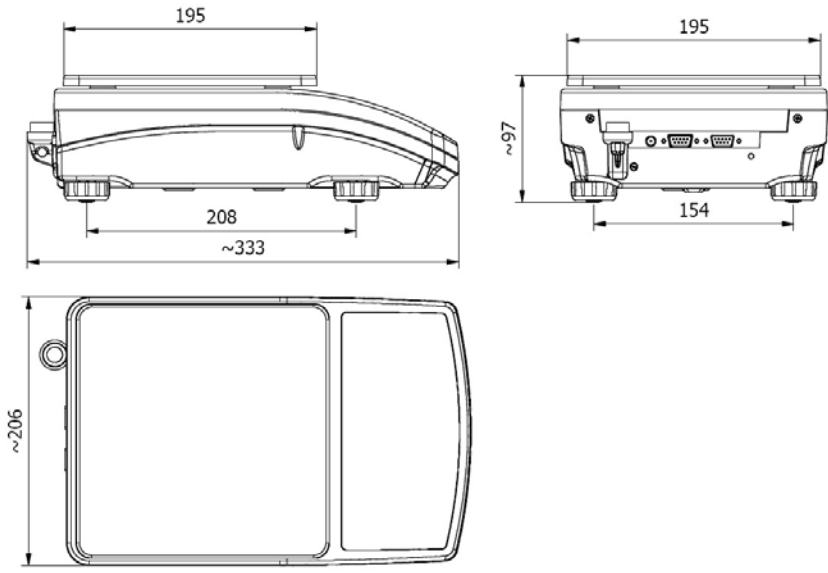

Scales WLC/A2

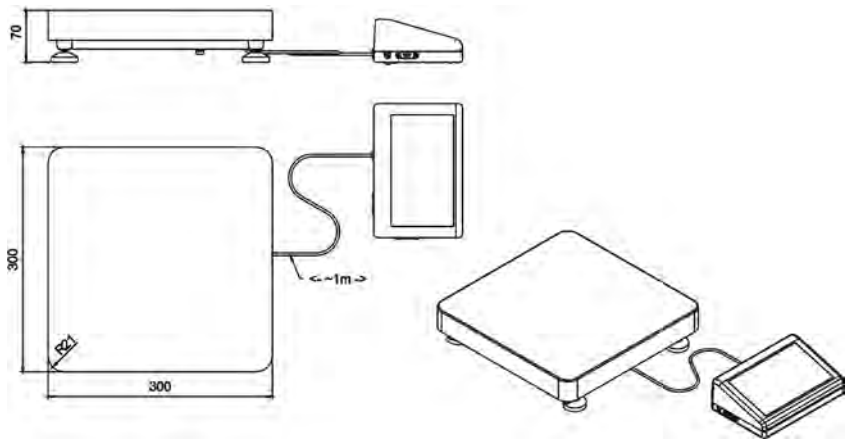

Scales WLC/F1/K

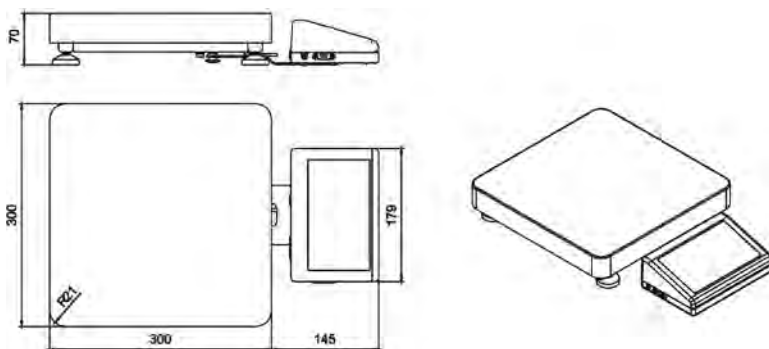

Scales WLC/F1/R

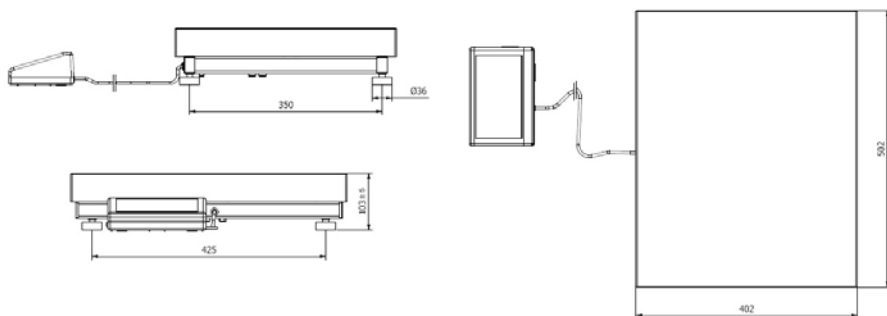

Scales WLC/C2/K

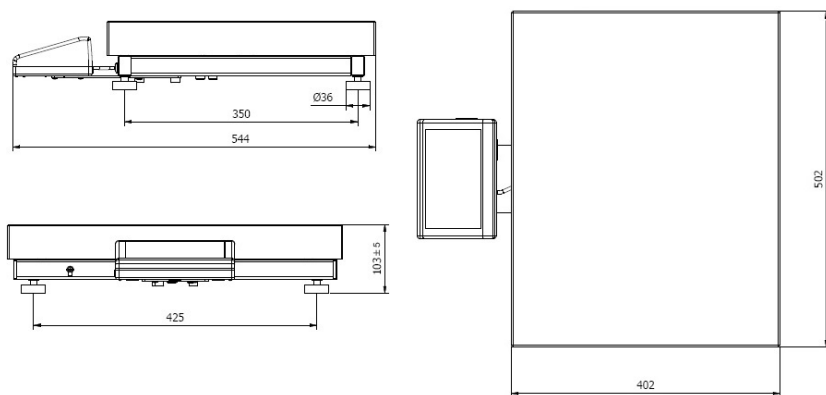

Scales WLC/C2/R

5. UNPACKING AND ASSEMBLY

- Unpack and put the scale on a flat even stable surface far away from sources of heat,
- Remove the transport protection:

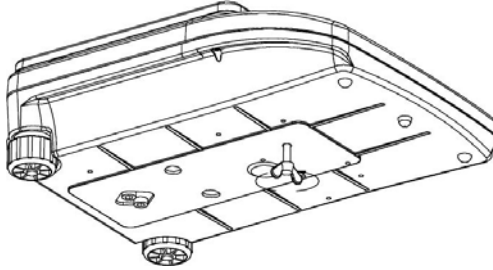

Scales WLC.../C/2

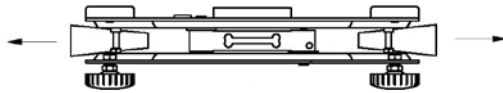

Scales WLC/F1, WLC/C2

- Install the weight pan according to the drawings below:

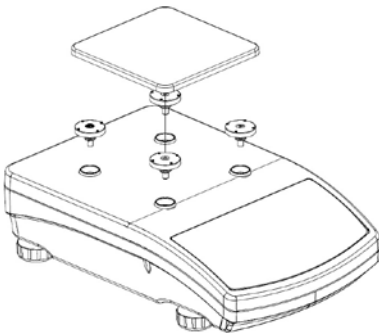

Scales WLC/A1

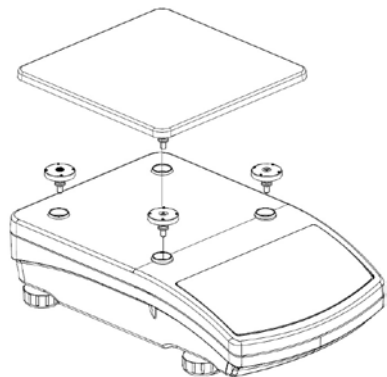

Scales WLC/A2

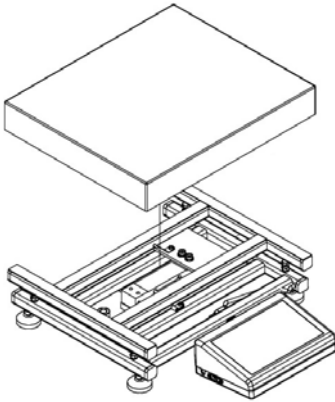

Scales WLC/F1/R, WLC/C2/R

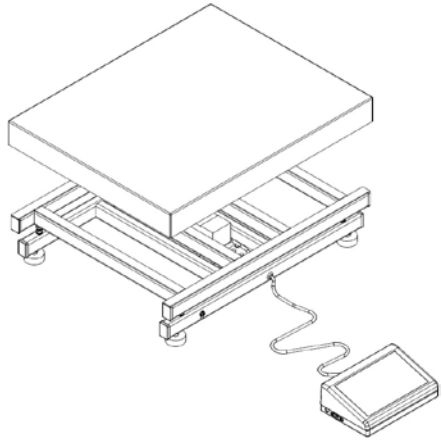

Scales WLC/F1/K, WLC/C2/K

6. UNDER-PAN WEIGHING

WLC scales offer under-pan weighing option wherein the load is weighed when hanged under the device. This is especially useful when there is a need to weigh load of non-standard dimension, shape or load that generates electromagnetic field.

Preparing the scale for under-pan weighing:

1. Unpack the scale, assembly it following point 5 and, turn the scale one side down.

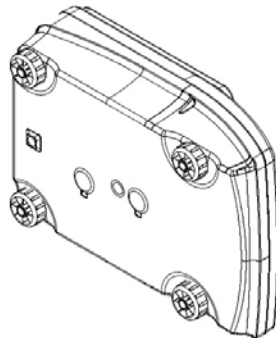

2. Remove the hole plug.

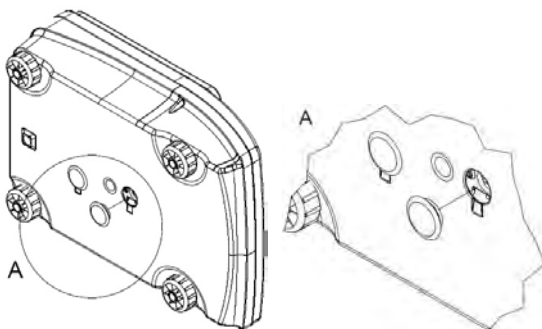

3. Fix the hook.

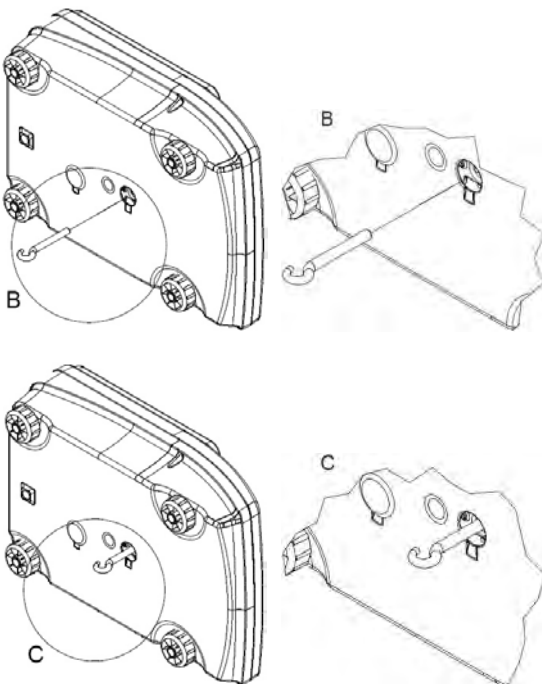



4. Turn the scale bottom side down.

7. GETTING STARTED

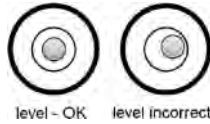
- After unpacking and mounting the scale level it out. Use levelling legs and the level condition indicator installed in the basis of the scale.



- Turn the device on using the  key – keep pressing the key for about 0.5 sec,
- Wait for the test completion,
- Then you will see **zero indication** and pictograms:

 - zero indication

 - stable result

kg - weight unit

- If the indication is not zero press  key.

Caution:

In case of verified scales in II OIML class with divisions $e=10d$ (where: d – reading division, e – verified division) the last digit will be marked as shown below:



8. BALANCE LEVELLING

- Operation temperature range for this device is outlined as $+15^{\circ}\text{C} \div +30^{\circ}\text{C}$;
- After powering up this device requires 30 minute warming up;
- During the worm-up time the indication can change;

- User calibration should be performed after the warm-up time.
- Temperature and humidity changes during operation can increase measurement errors, which can be minimized by performing the user calibration process.

9. KEYPAD

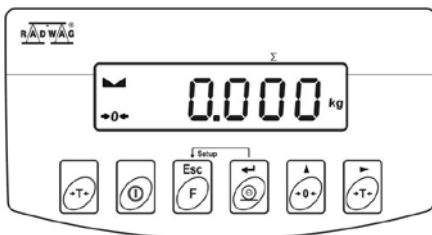

Keypad of WLC/A1, WLC/A2 series

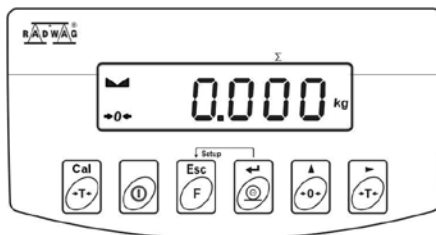

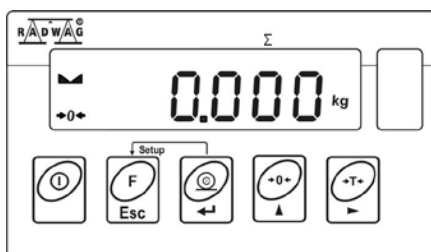

Keypad of WLC.../C2 series



Keypad of WLC/F1, WLC/C2 series

Notice:

Scales of WLC/A2 series are equipped with an additional key  for taring and has no additional functions but the keypad of the WLC.../C/2

scale include an additional key  for direct starting the process of internal calibration. Because the functionality and operation of the rest of the keys is the same, the further part of this manual describes the keypad of WLC/F1, WLC/C2 series.

10. KEYS' FUNCTIONS



Switching on/off



Function key (operation mode selection)



Sending a weighing result to RS232



Zeroing





Tarring



Manual internal calibration (WLC.../C/2 scales)



Notice:



After pressing  +  keys' functions changes. The way of operation in this mode is described in details further in this manual.

11. INSCRIPTIONS ON THE DISPLAY

No	Text string	Description
1	FIL	Filter level
2	bAud	Transmission baud rate
3	PCS	Piece counting
4	HiLo	+/- control according to a standard mass
5	rEPL	Automatic printout
6	StAb	The condition of printing data
7	Auto	Autozero correction
8	t1	Power save – time to switch off while no operation

9	toP	Latch of the max measurement
10	Add	Totalizing
11	AnLS	Weighing animals
12	tArE	Memory of 9 tare values
13	-0-	Indication in autozero zone (indication = exact zero)
14		Stable result (ready to read)
15	PCS	Operation mode - counting pieces
16	kg (g)	Operation mode - weighing
17		Rechargeable battery pack or battery discharged (BAT-LO)
18	Net	Tare function has been used
19	Min	+/- control with reference to the standard mass: setting the lower threshold or mass below the first threshold
20	OK	+/- control with reference to the standard mass: load mass between the thresholds
21	Max	+/- control with reference to the standard mass: setting the upper threshold or mass over the second threshold
22	CALib	The stability test for the internal calibration procedure
23	CAL-H	Manual internal calibration
24	CAL-A	Automatic internal calibration after powering up
25	CAL-t	Internal calibration triggered of by temperature
26	CAL-C	Internal calibration triggered of by timer
27	Abort	Terminating of internal calibration

12. USER MENU

12.1. Submenus

User's menu is divided into **6** basic submenus. Each group has its own characteristic name preceded by the letter **P** and a number.

P1 rEAd

P 1.1	Fil		3
P 1.2	Auto		YES
P 1.3	tArA		no
P 1.4	Fnnd		YES

P2 Prnt

P2.1	Pr_n		StAb
P2.2	S_Lo		
P2.3	bAud		9600
P2.4	S_rS		8d1SnP

P3 Unit

P3.1	StUn		kg
------	------	--	----

P4 Func

P4.1	FFun		ALL
P4.2	Funi		no
P4.3	PcS		no
P4.4	HiLo		no
P4.5	PrcA		no
P4.6	Prcb		no
P4.7	AtAr		no
P4.8	toP		no
P4.9	Add		no
P4.A	AnLS		no
P4.b	tArE		no

P5 othr

P5.1	bL		Auto
P5.2	bLbt		70
P5.3	bEEP		YES
P5.4	t1		Auto
P5.5	CHr6		YES

P6 CAL

P6.1	St_u		* FUNCTION *
P6.2	uCAL		* FUNCTION *
P6.3	CA-C		0
P6.4	CA-r		YES

12.2. Browsing user menu

Use scale's keys to move inside the menu.

12.2.1. Keypad



Entering main menu

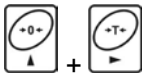

Inscribing tare value
Increasing a digit value by „1”
moving down in the menu



Battery / accumulator state monitoring



Toggling between gross / net values



Selecting the parameter or changing the value
of a selected parameter



Entering the selected submenu
or activating a parameter for changes



Confirmation (enter)





Leaving without changes or reaching a higher level
of the menu

12.2.2. Return to the weighing mode



The changes that have been introduced should be saved
in order to keep them in the memory for good.

While leaving parameters press  key until the text

<SAuE?> appears on the display. Then press: 

– to save changes or  – to leave without changes.

13. WEIGHING

Put a load you want to weigh on the weighing pan. When the  pictogram appears it means that the result is stable and ready to read. In order to assure long-term operation and appropriate measurements of weighted loads following precautions should be taken into consideration:

- Loads should be placed on the pan delicately and carefully in order to avoid mechanical shocks:

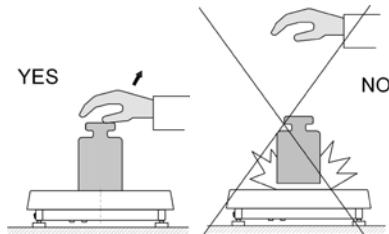

- Loads should be placed centrally on the pan (errors caused by eccentric weighing are outlined by standard PN-EN 45501 ch. 3.5 and 3.6.2):

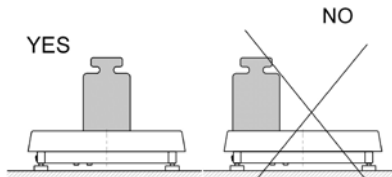

- Do not load the pan with concentrated force:

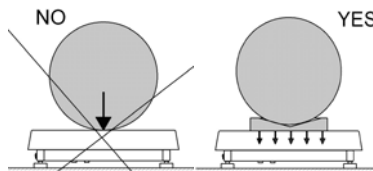

- Avoid side loads, particularly side shocks should be avoided

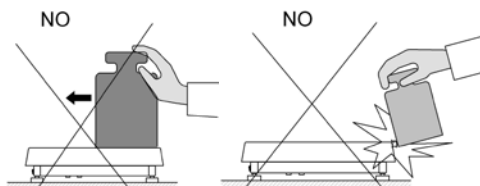

13.1. Tarring

In order to determine the net mass put the packaging on the pan.

After stabilising press  (**Net** pictogram will be displayed in the left upper corner and zero will be indicated).

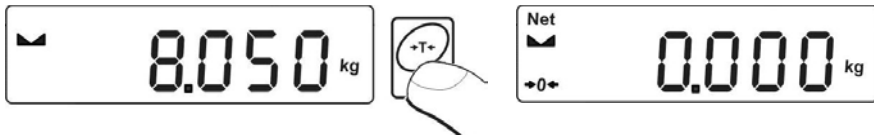

After placing a load on the weight pan net mass will be shown.

Tarring is possible within the whole range of the scale. After unloading the pan the display shows the tarred value with minus sign.





Notice:



*Tarring cannot be performed when a negative or zero value is being displayed. In such case **Err3** appears on the display and short audible signal will be emitted.*

13.2. Inscribing tare value

You can also inscribe a tare value. While in weighings mode press:

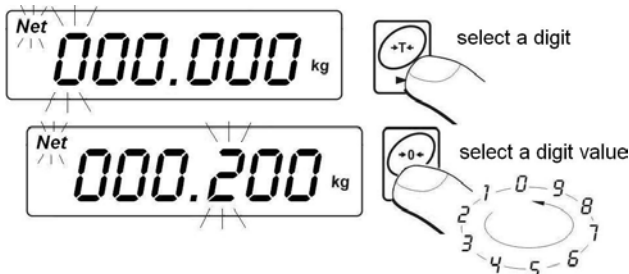
- Press simultaneously  and ,
- You will see :





- Using  and  set the tare value,
- Press ,
- Program returns to weighings mode. The inscribed tare value can be seen on the display with „-“ sign,
- Tare can be inscribed anytime in weighings mode.

Notice:

1. You cannot inscribe a new tare value when the tare value in memory is greater than zero. In the case of trying this the **<Err3>** message will be displayed and short audible signal will be emitted.
2. Users can also enter up to 9 tare values to the scale memory (see 16.10 of his manual).

13.3. Zeroing

To **ZERO** the scale press: .

The scale will display zero and following pictograms: **+0+** and . Zeroing is only possible within the scope of **±2%** of full scale. While zeroing outside the scope of **±2%** you will see **<Err2>**. Zeroing is possible only in stable state.

Notice:

*Zeroing is possible only within the **±2%** interval of the maximal range. If zeroing is performed beyond this range the **<Err2>** message and short audible signal will be emitted.*

13.4. Weighings in two ranges

Switching between the **I range** and the **II range** happens automatically (exceeding Max of the **I range**). Weighings in the second range is signalled by a pictogram in the top left corner of the display.

Then weighings is done with the accuracy of the **II range** to the moment of returning to zero (autozero range **+0+**) where the scale switches back to the **I range**.

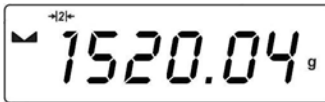



13.5. Selection of basic weight unit

This function is used to set weight unit the scale will start with.

Procedure:

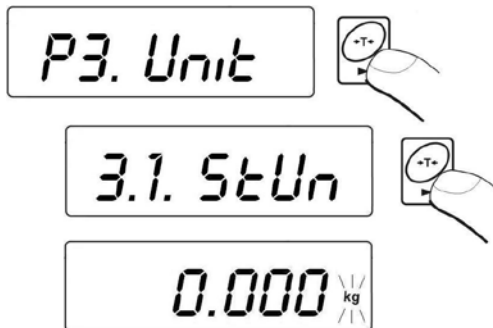
- Enter the submenu **<P3.Unit>** and then:



- press , until the expected unit appears on the display:



Options:

- When the basic unit is [kg], users can toggle between: [kg, lb, N], *for verified scales [lb] is not accessible*,
- If the basic unit is [g], users can toggle between: [g, ct, lb], *for verified scales [lb] is not accessible*,

- After you select the unit press , the scale returns to:

3.1 StUn

- Return to weighing according to chapter - 12.2.2.

Notice:

After turning on the scale always sets the basic unit.

13.6. Temporarily selected unit

This function is used to set weight unit the scale will use temporarily until the next power off or next selection.

Procedure:

- Press  and then:

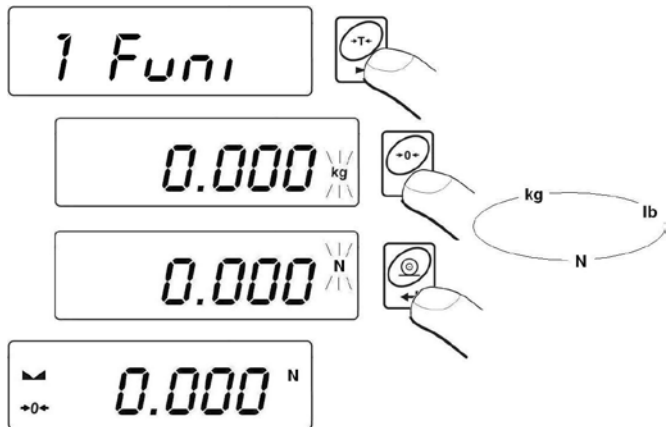

- After you select the unit you want come back to weighing procedure.

Options:

- A. When [kg] is a basic unit, users can select following units: [kg, lb, N], [*lb*] is not accessible for verified scales.
- B. When [g] is a basic unit, users can select following units: [g, ct, lb], [*lb*] is not accessible for verified scales.

14. MAIN PARAMETERS

Users can adjust the scale to external ambient conditions (filtering level) or particular needs (autozero operation, tare memory). This parameters are placed in <P1.rEAd> submenu.

14.1. Setting a filtering level

Procedure:

- Enter the submenu <P1.rEAd> and then:

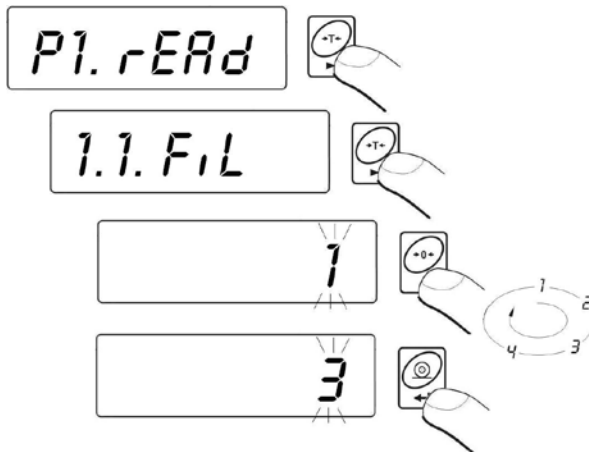

1 - 4 - level of filtering

- By pressing  select the filtering level you need

Notice:

Filtering level influences the time of stabilization. The higher the filtering level is the longer stabilization time is needed.

Return to weighing:

See - 12.2.2.

14.2. Median filter

This filter eliminates short changes (impulses) of measure signal (e.g. shocks).

Procedure:

- Enter the submenu <P1.rEAd> and then:

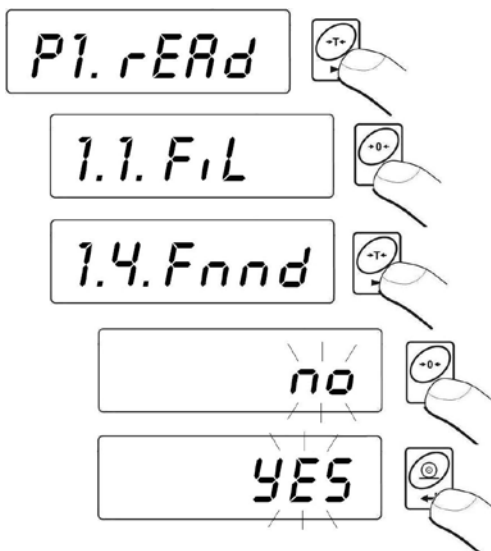



Fnnd **no** - filter disabled

Fnnd **YES** - filter enabled

Return to weighing:

See - 12.2.2.

14.3. Autozero function

The autozero function has been implemented in order to assure precise indications. This function controls and corrects „0” indication. While the function is active it compares the results continuously with constant frequency. If two sequential results differ less than the declared value of autozero range, so the scale will be automatically zeroed and the pictograms  and  will be displayed.

When AUTOZERO is disabled zero is not corrected automatically. However, in particular cases, this function can disrupt the measurement process e.g. slow pouring of liquid or powder on the weighing pan. In this case, it is advisable to disable the autozero function.

Procedure:

- Enter the submenu **<P1.rEAd>** and then:

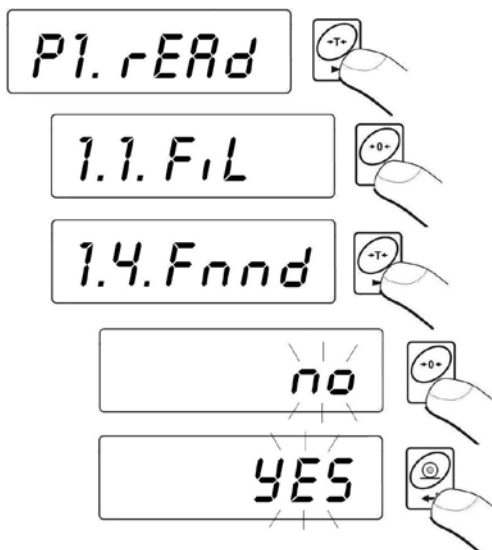

Fnnd **no** - filter disabled
Fnnd **YES** - filter enabled

Return to weighing:

See - 12.2.2.

14.4. Tare function

This parameters enables users to configure a tare function.

Procedure:

- Enter the submenu **<P1.rEAd>** and then:



- tArA AtAr** - **automatic tare function on** and is stored in balance memory after unplugging it from mains (Description of function operating point 16.6 automatic tare)
- tArA no** - **automatic tare function off** (user can turn on operating of automatic tare F6 AtAr – till unplugging the balance from mains)
- tArA tArF** - **tare memory function** – stores last value of tare in balance memory. It is automatically displayed after starting the balance. Value of tare is displayed with minus sign, and there is **Net** symbol indicated on the display. (user can turn on operating of automatic tare **F6 AtAr** – till unplugging the balance from mains)

Return to weighing:

See - 12.2.2.

15. RS 232 PARAMETERS

External devices connected to RS 232C have to be supplied from the same mains and common electric shock protection. It prevents from appearing a potential difference between zero leads of the two devices. This notice does not apply to the devices that do not use zero leads.

Transmission parameters:

- Baud rate - 2400 – 38400 bit / s
- Data bits - 7,8
- Stop bits - 1,2
- Parity control - no, even, odd

There are four ways of sending data via RS232 interface:

- **Manually** – after pressing ,
- **Automatically** – after stabilizing the indication over -LO- threshold
- **Continuously** – after it is activated in parameter or by a command sent via RS232
- **On external request** - see - „List of scale - computer commands”.

The indication can be sent as:

- **stable** – the indication is sent after the scale stabilizes.
- **any** – the indication is sent immediately after pressing the  key, this state is assign with <?> in the printout.

15.1. Printout type

This parameter is to select the type of printout.

Procedure:

- Enter the submenu <P2.Prnt> and then:

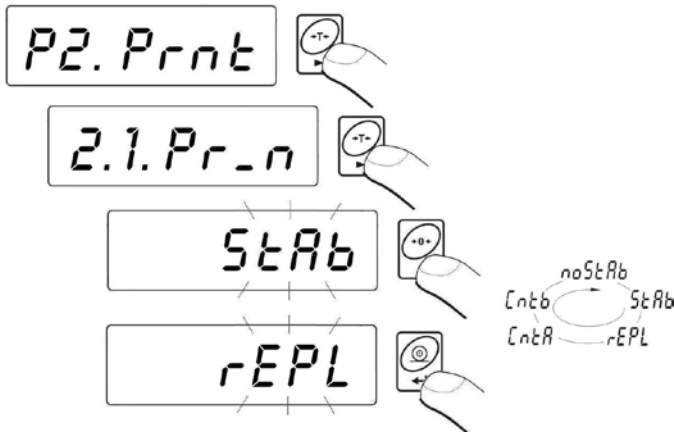

- | | | | |
|------|--------|---|---|
| Pr_n | noStAb | - | immediate printout
(not accessible in verified scales) |
| Pr_n | StAb | - | sending stable results |
| Pr_n | rEPL | - | automatic operation |
| Pr_n | CntA | - | continuous transmission in basic unit |
| Pr_n | Cntb | - | continuous transmission in present unit |

Return to weighing:
see 12.2.2.

15.2. Minimal mass threshold

This function is necessary while working with **automatic tare** or **automatic operation** or **weighing animals**.

Automatic tarring will not be applied until the indication (gross) is lower than the value inscribed in **S_Lo** parameter.

In automatic operation measurements (net) are sent via RS232 when the indication is equal or greater than the value inscribed in **S_Lo** parameter.

Weighings animals is performed when the indication is equal or greater than the value inscribed in **S_Lo** parameter.

Procedure:

- Enter the submenu **<P2.Prnt>** and then:

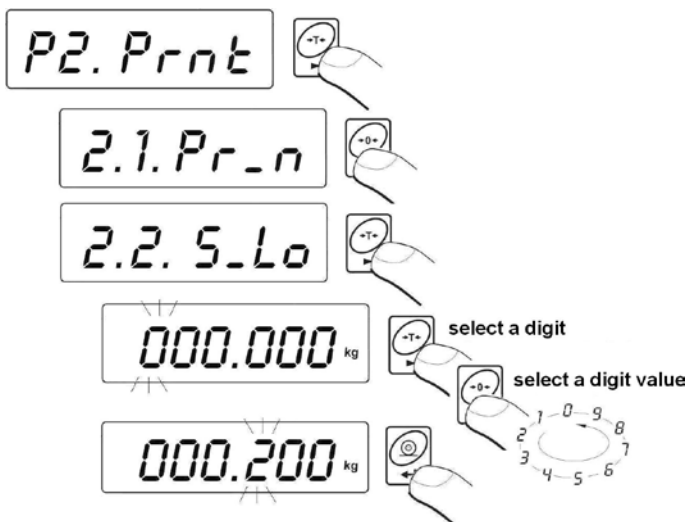

Return to weighing:
see 12.2.2.

15.3. Baud rate

Procedure:

- Enter the submenu **<P2.Prnt>** and then:

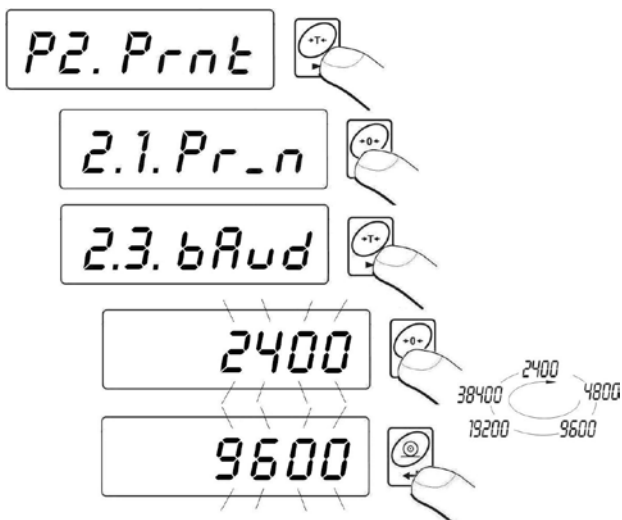

Return to weighing:
see 12.2.2.

15.4. Serial transmission parameters

Procedure:

- Enter the submenu **<P2.Prnt>** and then:

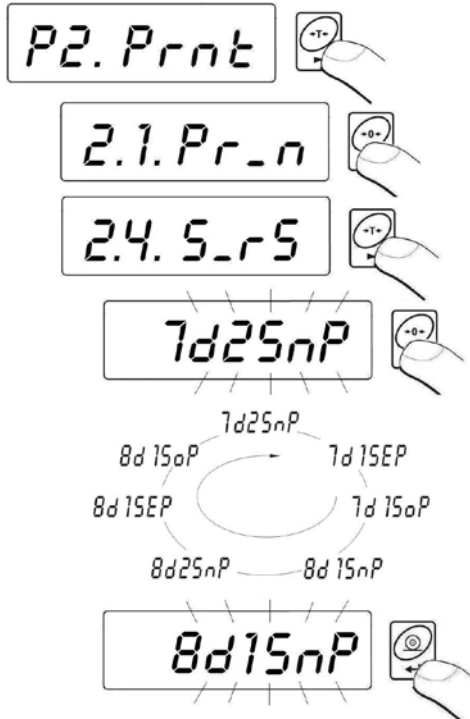

- 7d2SnP** - 7 data bits; 2 stop bits, no parity control
- 7d1SEp** - 7 data bits; 1 stop bit, EVEN parity control
- 7d1SoP** - 7 data bits; 1 stop bit, ODD parity control
- 8d1SnP** - 8 data bits; 1 stop bit, no parity control
- 8d2SnP** - 8 data bits; 2 stop bits, no parity control
- 8d1SEp** - 8 data bits; 1 stop bit, EVEN parity control
- 8d1SoP** - 8 data bits; 1 stop bit, ODD parity control

Return to weighing:
See 12.2.2.

16. OTHER PARAMETERS

The user can set parameters which influence the scale operation. They are gathered in the submenu **<P5.othr>** e.g. backlight and beep signal. Enter this submenu **<P5.othr>** according to chapter 12.2.

16.1. Backlight function

Program recognises the way the scale is supplied (mains, battery) and automatically selects the way of operating on the backlight:

- bl** – for mains,
- blbt** – for batteries or rechargeable battery pack.

16.1.1. Backlight for supplying from mains

Procedure:

- Enter the submenu **<P5.othr>** and then:

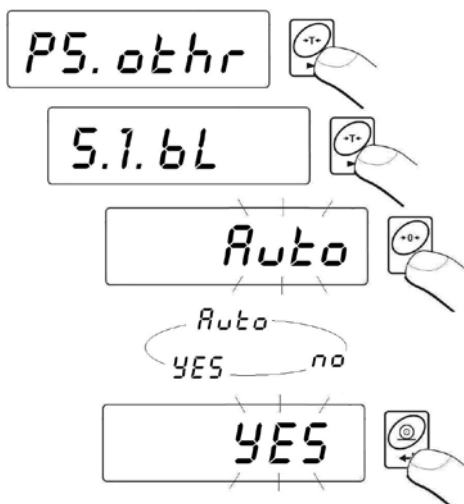

- bl no** - backlight switched off
- bl YES** - backlight switched on
- bl Auto** - backlight switched off automatically if indication becomes stable for about 10s

Return to weighing:
See 12.2.2.

Notice:

When bl=Auto, and the indication has not changed for 10s, the backlight is automatically switched off. The backlight is switched on again automatically after the result changes.

16.1.2. Backlight for supplying from batteries

The user can change the intensity of backlight from 0% to 100%. The lower the intensity is the longer the scale operates without recharging or exchanging batteries. When the intensity is set this function works as AUTO (described above).

Procedure:

- Enter the submenu **<P5.othr>** and then:

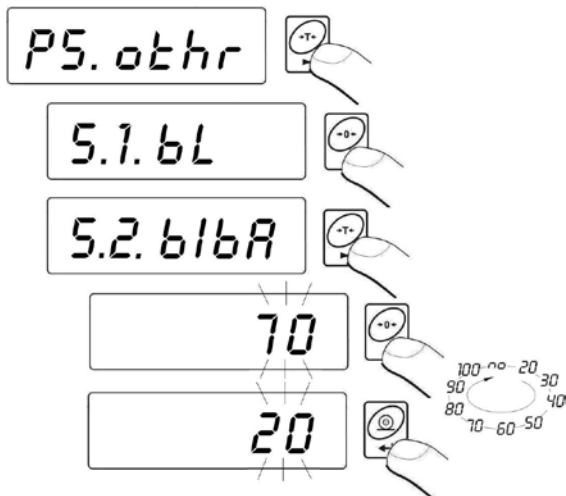

Return to weighing:
See 12.2.2.

Notice:

The more intense the backlight is the shorter the scale operates on batteries.

16.2. “Beep” signal – after pressing a key

Procedure:

- Enter the submenu <P5.othr> and then:

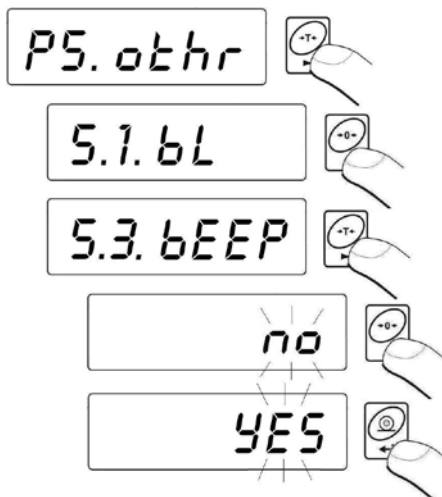

bEEP **no** - switched off
bEEP **YES** - switched on

Return to weighing:

See 12.2.2.

16.3. Automatic switch-off

This function is essential to save the battery power. The scale is switched off automatically when (function **t1 = YES**) no weighing appears in 5 minutes. (no changes on the display). In case when this function disrupts the operation (e.g. long time weighing procedures) or while working with connection to mains, switch off this function.

Operation according to the power supply:

Setting	Operation	
	Mains	Batteries / accumulator
t1 = 0	disabled	disabled
t1 = YES	enabled	enabled
t1 = Auto *	disabled	enabled

* automatic enabling/disabling according to the source of power.

Procedure:

- Enter the submenu <P5.othr> and then:

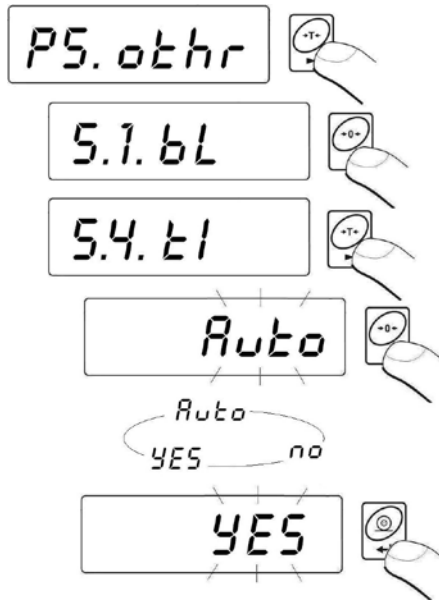

Return to weighing:
See 12.2.2.

16.4. Battery voltage level check

While supplying from batteries too low level of voltage is measured by software the pictogram  is displayed. It means that charging or exchanging batteries is required.

16.4.1. Checking the batteries

This function is to check the level of battery supply. It works only if:

- Weighing mode is set,
- Battery supply is set in parameters.

Procedure:

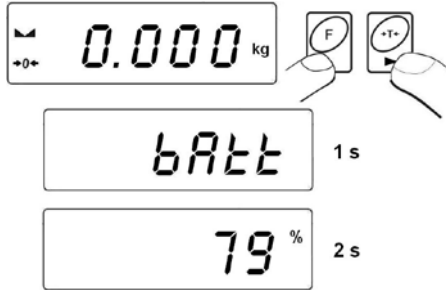



After displaying the level of batteries (in per cents) the program returns to weighing.

16.4.2. Battery discharge pictogram



The symbol (bat low) switches on when the voltage level drops to 18% of the accepted level of voltage. It means that charging or exchanging batteries is required.

Low level of batteries:

-  pictogram on the display,
- After some time the device will automatically switch off to protect the batteries from destructible discharging,
- Charging is signalled by  (blinking period about 2 seconds) on the display.

16.4.3. Accumulator charging option

This function allows to switch on charging algorithm for **NiMH** batteries (for scales of WLC/F1, WLC/C2 series) or a gel cell **SLA** accumulator (for scales of WLC/A2, WLC.../C/2 series):

- a) Parameter **<CHR6>** set to **<no>**:
 - Pictogram  does not appear, charging disabled,
 - During software initializing, after turning on **<bAtt>**.
- b) Parameter **<CHR6>** set to **<YES>**:
 - Pictogram  blinks slowly (period about 2 seconds), charging is enabled,

- Message **<nImh>** appears on the display (for scales of WLC/F1, WLC/C2 series) or **<SLA>** (for scales of WLC/A2, WLC.../C/2 series),
- In case of damaging accumulators or lack of it the pictogram  blinks quickly (period about 0.5 sec).

Notice:

WLC/F1, WLC/C2 scales are equipped with **NiMH** batteries packs, **R6 (AA)** size and Power adapters for supplying from mines.

Procedure:

- Enter the submenu **<P5.othr>** and then:

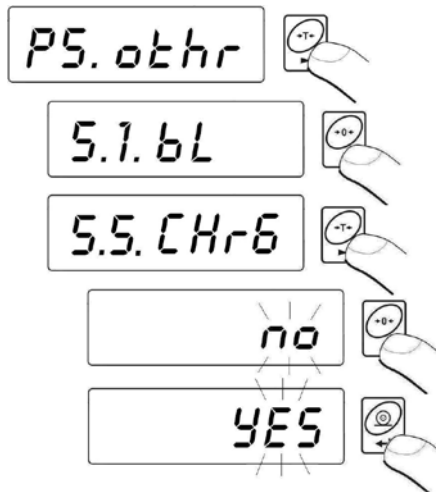

CHr6 YES - enabled
CHr6 no - disabled

Return to weighing:

See 12.2.2.

16.4.4. Formatting rechargeable battery packs

WLC/F1, WLC/C2 scales are equipped with **NiMH** batteries packs, **R6 (AA)** size and Power adapters for supplying from mines. They need formatting after first powering up. It is crucial for batteries lifetime to undertake this process. Formatting consist in charging and total discharging (without meantime charging).

Procedure:

1. Supply the indicator from mains,
2. Charge batteries for 12 hours (time of charging 2200mAh batteries),
3. After 12 hours unplug from mains,
4. Use the device up to the moment of self powering down,
5. Repeat the process of charging starting from point 1.

Notice:

They reach their optima capacity after three cycles of full charging and discharging.

17. OPERATION MODES

17.1. Setting accessibility of operation modes

In this parameter group users can disable/enable accessibility of functions after pressing  key.

Procedure:

- Enter the submenu **<P4.Func>** and then:

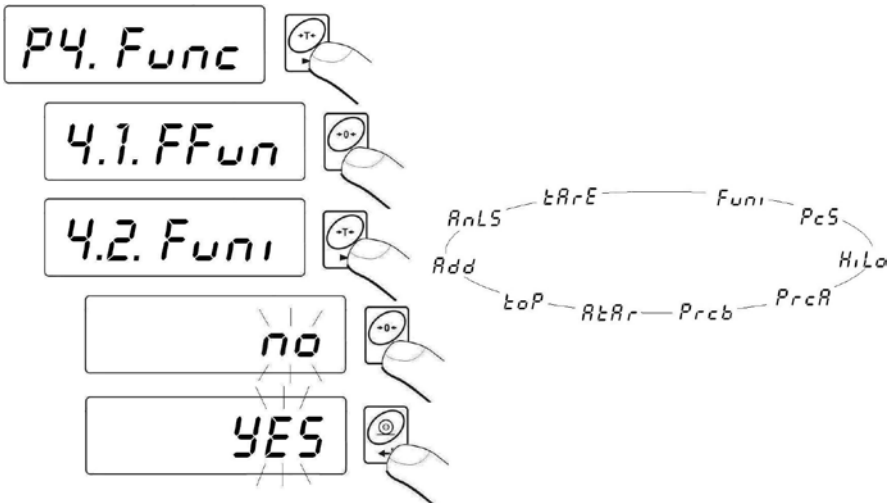

no – mode is disabled
YES – mode is enabled

Notice:

- Procedure for setting accessibility of other working modes is performed likewise.
- In order to make specified working modes accessible, press  key and set **<4.1. FFun>** parameter to value **<All>** (see point 16.2 of this manual).

Return to weighing:
See 12.2.2.

17.2. Selecting quantity of operation modes

This function enables user to set how many chosen and used by an operator working modes are to be accessible after pressing  key, (ALL) or only one.

Procedure:

- Enter the submenu **<P4.Func>** and then:



After choosing setting press  key. The program will return to displaying name of submenu **<P4.1.FFun>**.

Return to weighing:
See 12.2.2.

17.3. Counting pieces of the same mass

Standard solution is equipped with option of counting small pieces of the same mass. It is possible to execute a tare function in this operating mode in order to tare a container value.

Notice:

1. Counting pieces does not work together with other scale functions,
2. The counting pieces function is not saved as a default start function so it is not remembered after restarting.

Procedure:

- Enter to **<PcS>** function:

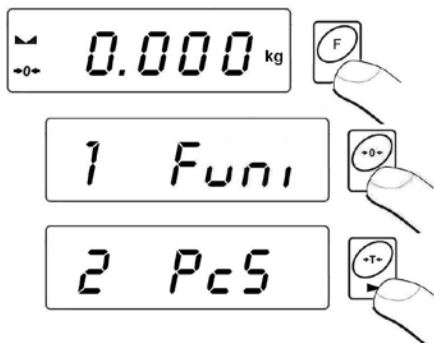

- You will see a blinking value of sample quantity.
- Press  key to start setting quantity of sample, you have a few options to chose from:

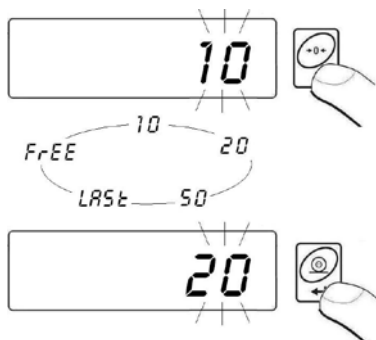

- If option **<LAST>** is chosen in the scale program displays estimated unit mass of the last piece (about 3 seconds) and then goes to **Counting pieces** automatically setting the previously displayed value as valid for the procedure.
- If the **<FrEE>** option is selected you will see:



- Using and enter the required sample quantity, where: - selection of digit position, - setting the digit,
- Confirm the value by pressing ,
- You will see **<LoAd>** on the display and then:

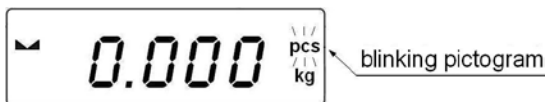

- If weighing is performed in a container put the container on the pan first and then tare it. Then put the declared quantity of pieces on the pan and confirm it when stable (signalled by):

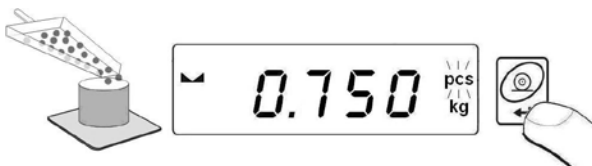

- The program will automatically calculate the mass of a single piece and go on to the **Piece Counting** mode (**pcs**). You will see the following display:

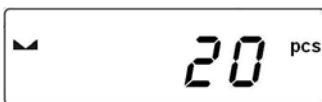

Notice:

1. If a user presses the  key when load is not present on the pan, the message **-Lo-** will be indicated for a few seconds and the scale will automatically return to weighing.
2. In order to comply with the rules of appropriate counting pieces put as many pieces as possible during unit mass adjustment. Single piece mass should not be less than 5 divisions.
3. If a single piece mass is lower than a reading interval d the display will show the **<Err5>** message (see ch. 22. Error messages) and short audible signal will be emitted than the scale returns to weighing.

Return to weighing:

- Press the  key twice.

17.4. +/- control referring to the inscribed standard mass

Procedure:

- Enter to **<HiLo>** function:

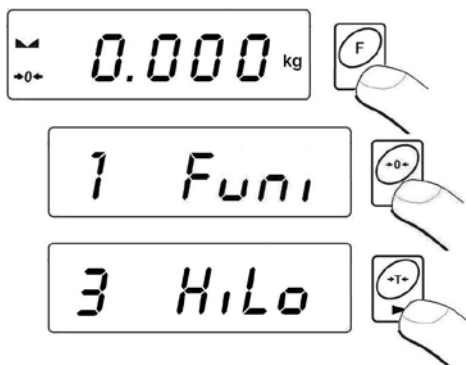

- The program enters the window of setting the lower threshold of weighing (**Min**):

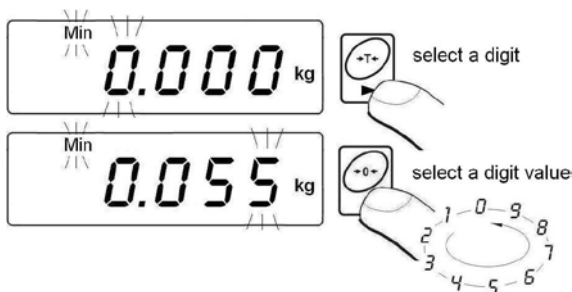

- The inscribed value confirm by pressing , the program will automatically go to the higher threshold of weighing (**Max**):

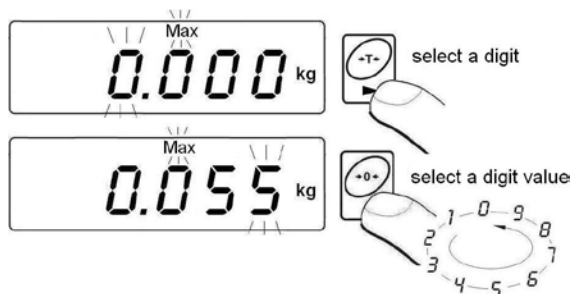

- The inscribed value confirm by pressing , the program will automatically go to the main window.
- During setting threshold values following cases take place:

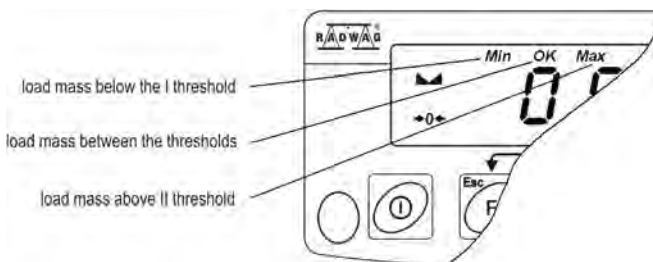

Notice:

If a user erroneously enters a value of the lower threshold higher than the upper one, the scale will indicate an error message and will return to weighing.

Return to weighing:

- Press the  key twice.

17.5. Control of % deviation referring to the inscribed standard mass

Scale software enables control of deviation (in %) of weighed loads mass referring to the inscribed standard mass. Mass of standard can be determined by its weighing (**PrcA** function) or entered to the scale memory by an user (**PrcB** function).

17.5.1. Standard mass determined by its weighing

Procedure:

- Enter to **<PrcA>** function:

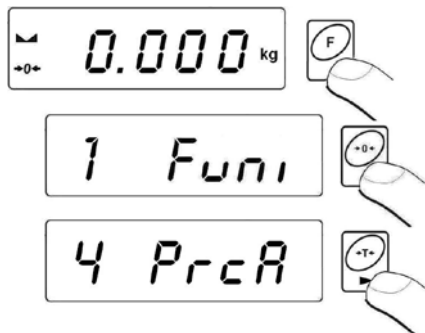

- You will see **<LoAd>** on the display and then:

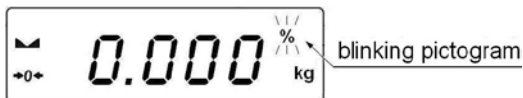

- place an load on the pan which mass will be accepted as standard
- press  to confirm this operating mode
- after few seconds the indication **100,00%** will be displayed
- From this moment display will not indicate mass of weighed load but deviation of load mass placed on the pan referring to the mass of standard (in %).

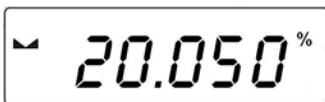

Return to weighing:

- Press the  key twice.

17.5.2. Mass of standard inscribed to scale memory



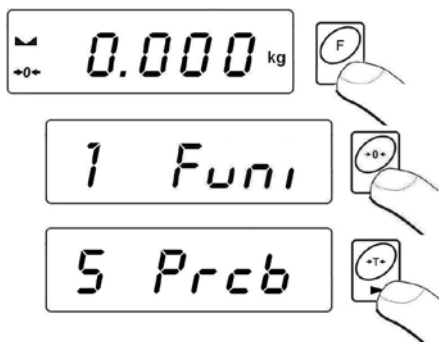

Procedure:

- Enter to <PrcB> function:



- The program goes to the weight display window:



- Using  and  set **standard mass**,
where:  - digit selection,  - digit setting.
- Confirm the entered value by pressing .
- You will see the indication equal to **0,000%**,
- From this moment display will not indicate the mass of weighed load but deviation of the load mass placed on the pan referring mass of standard (in %).

Return to weighing:

- Press the  key twice.

17.6. Automatic tare

This function is useful for fast net mass determination of weighed load in case when tare value of is different for each load. In case when the function is active the cycle of scales operating looks as follows:

- press zeroing key when the pan is empty,
- place the container for pieces,
- when indication is stable **automatic tarring** of the container mass will be performed (**Net** marker will appear in the upper part of the display),
- place a sample into the package,
- display will indicate net mass of sample,
- remove the sample together with the container,
- display will indicate tare mass with minus sign,
- place a container for the next sample. When indication is stable automatic tarring will take place (**Net** marker will appear in the upper part of the display),
- place next sample into the package.

Procedure:

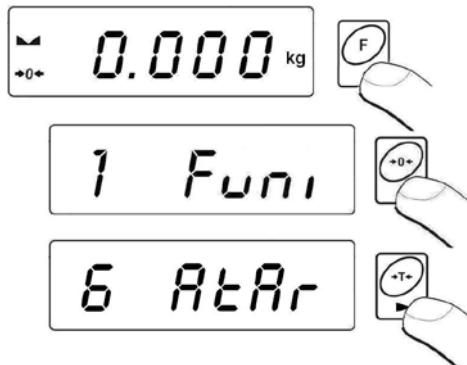

Return to weighing:

- Press the  key twice.

17.7. Measurement of maximal force on the pan – latch

Procedure:

- Enter to **<toP>** function:

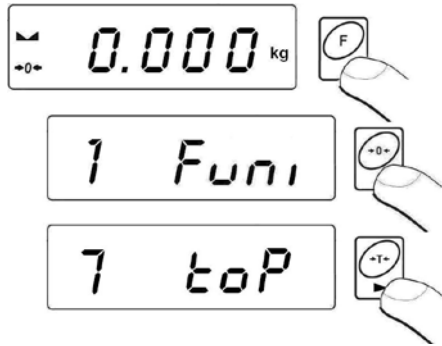

- Confirmation of choice of **<toP>** function is indication of the **Max** pictogram:



- Apply a force to the weighing pan,
- The display of scale will latch the maximum value of the force,
- Remove loads from the pan,
- Before the next measurement press the  key.

Return to weighing:

- Press the  key twice.

17.8. Totalizing

Scale software is equipped in a totalizing function of single weighings. The totalizing procedure can be documented on the printer connected to the indicator.

17.8.1. Enabling the work mode

Procedure:

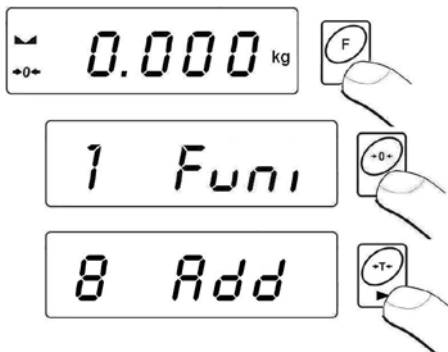

- Enter to **<Add>** function:





- A letter „P” in the left side of the display is a confirmation that **<Add>** function have been selected:



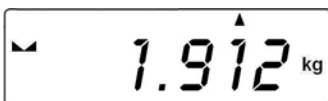

17.8.2. Totalizing procedure

- Enter **<Add>** function according to ch. 17.8.1,
- Put the first load on the pan. If the weighing procedure is performed in a container put the container on the pan first and tare it. Then put the first load on the pan and confirm it by pressing  when stable (signalled by ) ,
- You will see a sum of weighings on the display, the „▲” pictogram in the upper right corner will be displayed and the weighing result will be printed on the printer connected to the indicator.



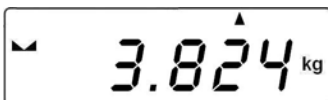

- Take off the load from the pan, indication returns to **ZERO** and the letter „P” in the left part of the display appears,
- Put the next load on the pan,
- After stabilizing press , the sum of first and second weighing will appear on the display, the „▲” pictogram in the upper right corner will be displayed and the second weighing result will be printed on the printer connected to the indicator:



- Press  to complete the procedure (with the loaded or unloaded pan), a sum of all weighings will be printed:

(1) 1.912 kg
(2) 1.912 kg

TOTAL: 3.824 kg



- In case of pressing  one more time with loaded pan, you will see the **<unLoAd>** message. Unload the pan, the scale will return to **ZERO** and the letter „P” in the left part of the display will appear. The scale is ready for the next procedure.
- In case of pressing  one more time with loaded pan, you will see the letter „P” in the left part of the display will appear. The scale is ready for the next procedure.

17.8.3. Memory of the last value of sum of weighed goods

After interrupting (e.g. switching off) the totalizing procedure, it is possible to restart the procedure without losing data. In order to do it just enter the totalizing procedure:

- Enter **<Add>** function again according to the ch.17.8.1 of the manual,
- You will see the last memorized sum of weighings on the display



- In order to continue the procedure press , the indication returns to **ZERO** and the letter „P” appears in the left part of the display. The scale is ready for weighing,

- In order to terminate the previous totalizing procedure press  key, , or . You will see the letter „P” in the left part of the display. The scale is ready for weighing.



17.8.4. Return to weighing

- Press  key, you will see:

Print ?

- Before leaving the **<Add>** function it is possible to print out subsequent weighings and the sum of weighings on the connected printer (press  to print, press  to cancel).
- The following message will appear on the display:

ESC ?

- Press  key to return to weighing,
- Press  to return to totalizing.

Notice:

*In case of overflow of the range of the display in totalizing you will see **<5-FULL>** message in the display. In that case unload the pan and press  to complete the procedure with a printout of sum of all weighings or put a lower mass on the pan which does not cause the overflow error.*

17.9. Weighing animals

Procedure:

- Enter to **<AnLS>** function:

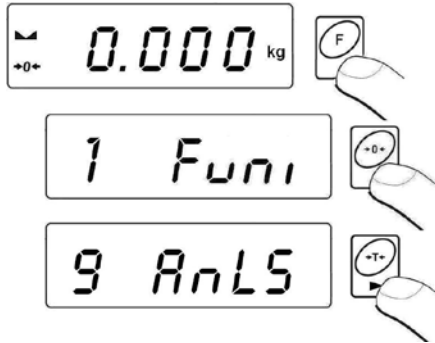

- The **<tinnE>** message appears on the display for **1s**, and then the program goes to the window of setting the duration time (in seconds) of the animal weighing process:

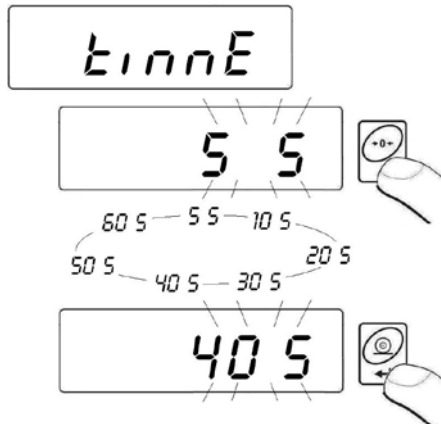

- Confirm the selected value by pressing .
- You will see the following window:



- Load an animal to the platform,
- After exceeding the **-LO-** value (see 15.2), program starts the weighings process. The appearance of subsequent hyphens <-----> showing the progress,
- After completing the process of weighings the result is latched on the display and additionally the **OK** pictogram is shown in the upper part of the display:

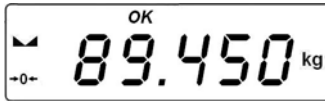

- You can start the procedure of weighing animals again by pressing ,
- After removing the animal from the platform program returns to the window:



Return to weighing:

- Press .

17.10. Tare memory

Users are allowed to Enter Up to 9 tare values to the memory.

17.10.1. Entering the tare value to the scale memory

Procedure:

- Enter to <tArE> function:

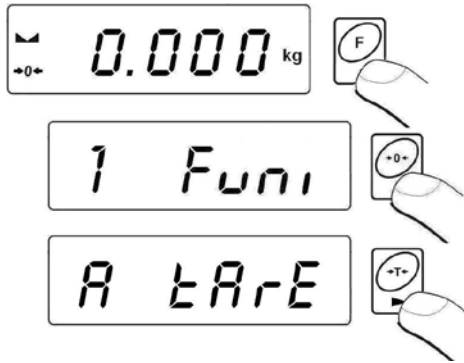

- The program goes to displaying the first value from the selection of tare values <tArE 0> (press  to chose different values):

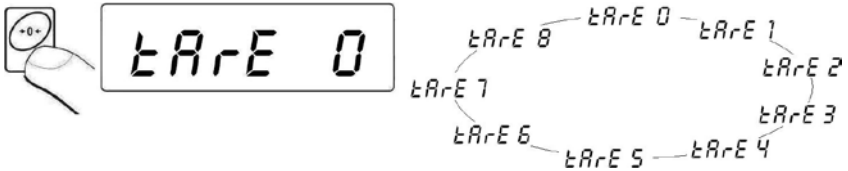

- After selecting the right position press  and you will see an editing field:

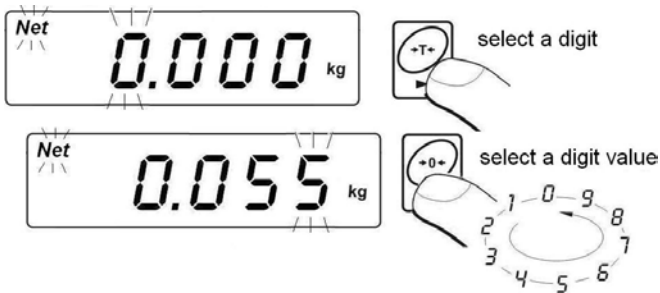

- Enter the selected **tare value** to the scale memory ,

- The program returns to the following window:

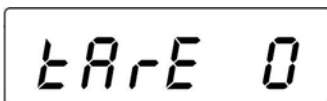



Return to weighing:

- Press .

17.10.2. Selecting a tare value from the memory

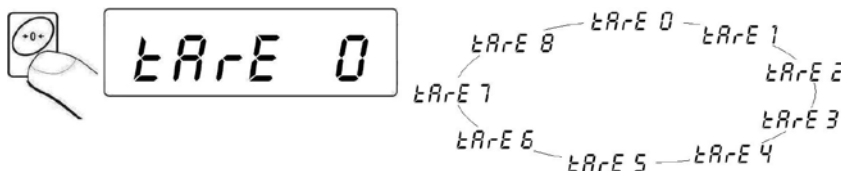
- Enter <tArE> function according to the ch. 17.10.1 of the manual,
- The program goes to displaying the first value from the selection of tare values <tArE 0> (press  to chose different values):



- To use an entered tare value press , you will see the tare value on the display preceded by the „-„ sign and the **Net** pictogram:



Caution:

A tare value from the memory is not remembered after powering off and on the scale.

18. SCALE CALIBRATION

In precise scales changes of gravitational acceleration have noticeable influence. The gravitational acceleration changes with altitude and latitude. Every scale has to be adjusted to the place of use especially when the place changes. Frequent calibration also prevents weighing process from the influence of humidity and temperature.

For assuring the maximal accuracy of weighing a periodical user calibration is required.

Calibration should be performed:

- Before weighing process,
- After a long break between series of measurements,
- After the ambient temperature change.

Conditions of triggering off calibration:

- Automatic internal calibration:
 - Started by adequate temperature change,
 - Started after adjusted time period,
 - Started after powering up the device,
- Manual internal calibration started from the keyboard,
- Calibration with an external weight.

Caution:

*Internal calibration is accessible only in WLC.../C/2 scales of WLC series. In WLC.../C/2 scales calibration with an external weight is not accessible. It should be remembered that the calibration process should be performed with the empty pan! The calibration process can be terminated by pressing **Esc** when necessary.*

18.1. Internal calibration

An option for WLC.../C/2 scales of WLC series only

The internal calibration process can be initiated manually or automatically. Press **Cal** to initiate it manually. Automatic calibration system performs internal calibration and informs a user on the display about the course of the process.

18.1.1. Manual internal calibration

Procedure:

- While in weighing mode press ,
- The scale program starts to check stability conditions for the calibration process and displays the following message:

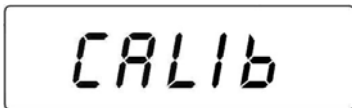

CALIB

- Then the program automatically goes to the internal calibration procedure which is signalled by the following message:

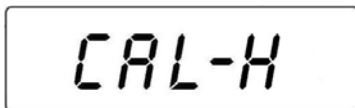

CAL-H

- After completion of the calibration process program returns to the weighing mode,
- Calibration process can be terminated anytime by pressing  which is signalled by the following message on the display:



Abort

Notice:

1. *It should be remembered that internal calibration should be performed with unloaded pan with keeping possibly constant ambient conditions.*
2. *If the calibration process lasts longer than 15 seconds scale software will react with <Err8> displayed and a short sound and then the calibration procedure will start again.*

18.1.2. Automatic internal calibration

The automatic calibration process can be triggered off by 3 different factors:

- **Calibration after powering up**

- After performing the start procedure the scale program starts to check stability conditions for the calibration process and displays the following message:



A rectangular digital display showing the text "CALIB" in a stylized, seven-segment font.

- Then the program automatically goes to the internal calibration procedure which is signalled by the following message:

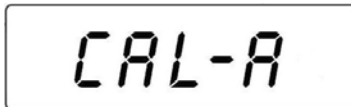

A rectangular digital display showing the text "CAL-A" in a stylized, seven-segment font.

- After completion of the calibration process program returns to weighing mode.

- **Calibration triggered off by temperature changes**

- The scale has been equipped in the temperature monitoring system;
- Temperature triggers off calibration every time when the internal system measures the temperature change greater than 3°C;
- The calibration procedure triggered off by the temperature change starts with checking which is signalled by the following message:

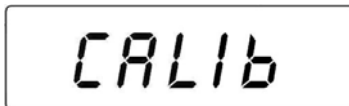

A rectangular digital display showing the text "CALIB" in a stylized, seven-segment font.

- Then the program automatically goes to the internal calibration procedure which is signalled by the following message:

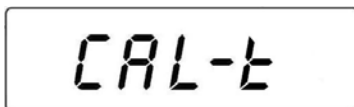

CAL-t

- After completion of the calibration process program returns to the weighing mode.

- **Calibration triggered off by timer**

- The time condition for subsequent automatic calibration is 3 hours. It means that, when no other triggering factor appear, the calibration will appear every 3 hours;
- The calibration procedure triggered off by the time change starts with checking which is signalled by the following message:



CALib

- Then the program automatically goes to the internal calibration procedure which is signalled by the following message:

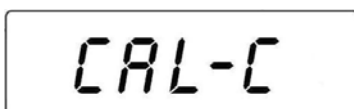

CAL-C

- The program for non-verified scales has a parameter for setting a maximal time interval between subsequent internal calibration.

Procedure:

- Enter the submenu **<P6.CAL>** and then:

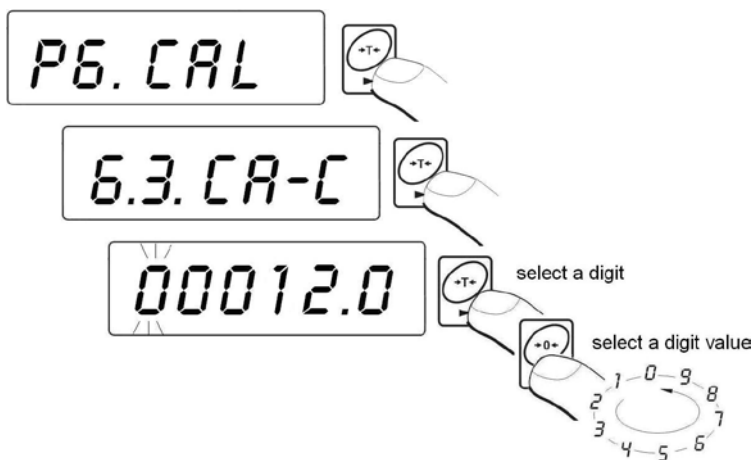

- After completion of the calibration process program returns to weighing mode.

- Calibration process can be terminated anytime by pressing  which is signalled by the following message on the display:

Abort

Notice:

1. It should be remembered that internal calibration should be performed with unloaded pan with keeping possibly constant ambient conditions.
2. If the calibration process lasts longer than 15 seconds scale software will react with **<Err8>** displayed and a short sound and then the calibration procedure will start again.

18.1.3. A report from calibration

Users, in parameter <P6.4.CA-r>, can enable a function of automatic printout of report form calibration process on a connected printer.

Procedure:

- Enter the submenu <P6.CAL> and then:

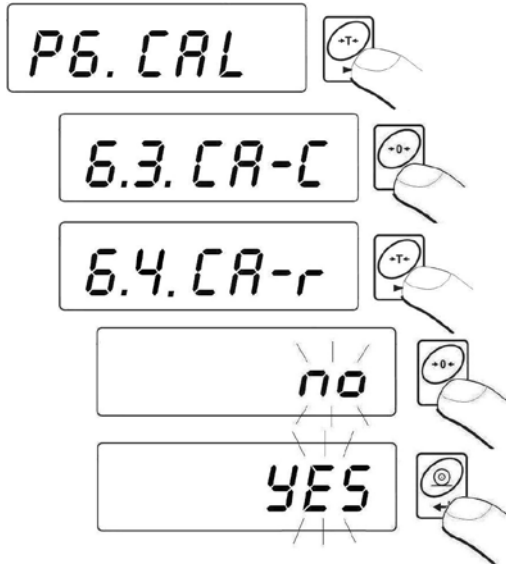

Return to weighing:

See - 12.2.2.

The example printout of report from calibration:

```
*****Calibration report*****  
  
Calibration:                internal  
Triggered off by:           init  
Difference:                  -00.[5] g  
  
Name: .....
```

18.2. External calibration

*Option only for non-verified scales
Not accessible in WLC.../C/2 scales of WLC series*

Procedure:

- Enter submenu <P6.CAL> and then:

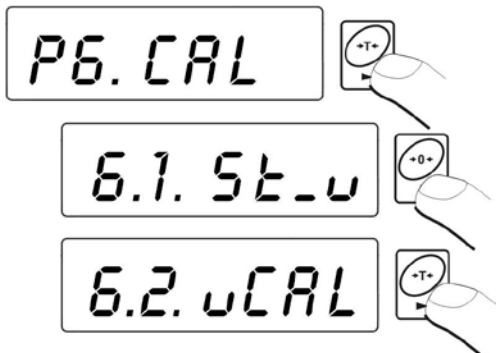

- Following messages will be displayed:

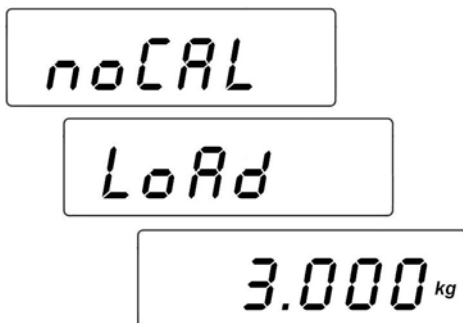

- During this time start mass is adjusted, and after completing the procedure calibration weight mass is displayed (e.g. **3.000kg**),
- Place the required weight on the pan,
- Calibration process starts automatically after placing the adequate weight that is signalled by the following message:

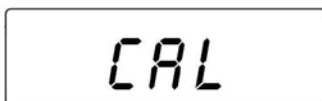

- The completion of the calibration procedure is signalled by the following message:

unLoAd

- Take off the weight from the pan, the message **<donE>** is displayed for 1s and the program returns to the calibration submenu:

donE

6.2. uCAL

- Calibration process can be terminated anytime by pressing  which is signalled by the following message on the display:

Abort

- Return to weighing with saving changes that have been made.

Caution:

*If the calibration process (span adjustment) lasts longer than 15 the **<Err8>** message will be displayed and short audible signal will be*

emitted. Press  to perform calibration again with more stable ambient conditions!

18.3. Start mass adjustment

*Option only for non-verified scales
Not accessible in WLC.../C/2 scales of WLC series*

The scale can require only adjusting new start mass. In this scale adjusting start mass can be excluded from the process of calibration and performed separately.

Procedure:

- Enter submenu <P6.CAL> and then:

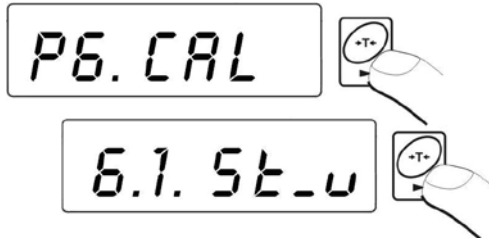

- The following messages are displayed:



- The new start mass is adjusted and returns to the submenu:

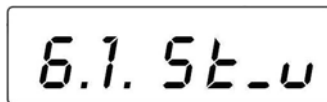

- The process of start mass adjustment can be terminated by pressing , which is signalled on the display:

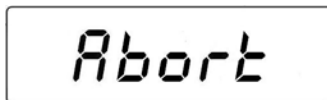

- Return to weighing with saving changes that have been made.

Caution:

If the start mass adjustment lasts longer than 15 the <Err8> message will be displayed and short audible signal will be emitted. Press  to perform calibration again with more stable ambient conditions!

19. COOPERATION WITH PRINTER



Each time the  key is pressed a current mass value together with mass units is sent to RS 232 interface.

Depending on setting of **STAB** parameter it can be printed out with temporary or stable value. Depending on setting of **REPL** parameter, printout will be automatic or manual.

Cable diagrams:

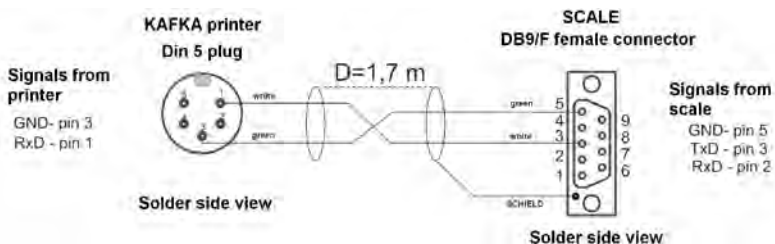

Scale – KAFKA printer cable diagram

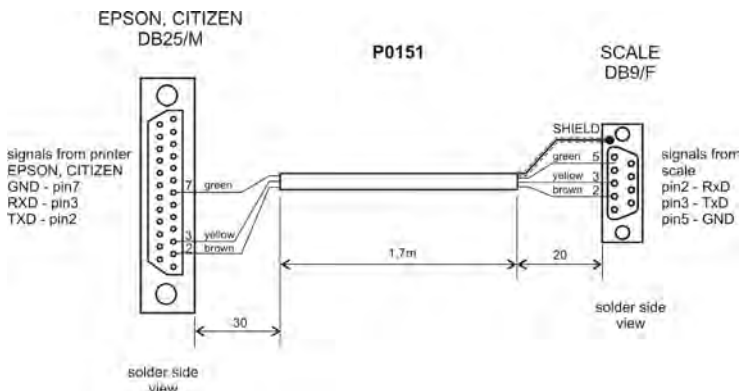

Scale – EPSON printer cable diagram

20. COOPERATION WITH COMPUTER

Sending weighing results to the computer can be done:

- manually
 - in continuous way
 - automatically
 - on the request from the computer
- after pressing  key,
 - after function activating or sending an appropriate command,
 - After stabilizing the indication
 - After sending a control command

These scales can cooperate with „**EDYTOR WAG**” program. The indicator window comprises the most important information from the scale display. The program allows to configure easily, e.g. design printouts, edit parameters. A precise description is issued in the „Help” file that accompanies the program.

Cable diagrams:

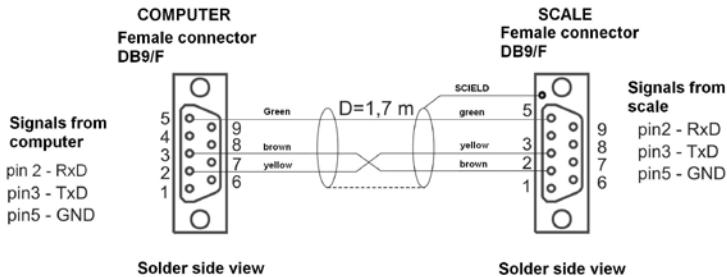

Scale – computer cable diagram

21. COMMUNICATION PROTOCOL

21.1. General information

- A. A character protocol scale-terminal has been designed for communication between RADWAG scales and external devices via RS-232 interface.
- B. It consists of commands sent from an external device to the scale and a responses from a scale.
- C. Responses are sent every time after receiving a command (reaction for any command).
- D. Using commands allows users to receive some information about the state of scale and/or influence the operation e.g.: requesting weighing results, display control.

21.2. A set of commands for RS interfaces

Commands	Description of commands
Z	Zeroing
T	Tarring
OT	Get tare
UT	Set tare
S	Send the stable result in basic unit
SI	Send the result immediately in basic unit
SU	Send the stable result in current unit
SUI	Send the result immediately in current unit
C1	Switch on continuous transmission in basic unit
C0	Switch off continuous transmission in basic unit
CU1	Switch on continuous transmission in current unit
CU0	Switch off continuous transmission in current unit
K1	Lock the scale keyboard
K0	Unlock the scale keyboard
NB	Give serial number
PC	Send all implemented commands

Notice:

1. Each command have to be terminated in CR LF;
2. The best Policy for communication is not sending another command until the former answer has been received.

21.3. Respond message format

After sending a request message you can receive:

XX_A CR LF	command accepted and in progress
XX_D CR LF	command completed (appears only after XX_A)
XX_I CR LF	command comprehended but cannot be executed
XX_^ CR LF	command comprehended but time overflow error appeared
XX_v CR LF	command comprehended but the indication below the
XX_OK CR LF	Command done
ES_CR LF	Command not comprehended
XX_E CR LF	error while executing command – time limit for stable result exceeded (limit time is a descriptive parameter of the scale)

XX - command name
_ - substitutes spaces

21.4. Command's description**21.4.1. Zeroing**

Syntax **Z CR LF**

Possible answers:

Z_A CR LF - command accepted and in progress
Z_D CR LF - command completed
Z_A CR LF - command accepted and in progress
Z_^ CR LF - command comprehended but zero range overflow appeared
Z_A CR LF - command accepted and in progress
Z_E CR LF - time limit for stable result exceeded
Z_I CR LF - command comprehended but cannot be executed

21.4.2. Tarring

Syntax: **T CR LF**

Possible answers:

- T_A CR LF** - command accepted and in progress
- T_D CR LF** - command completed
- T_A CR LF** - command accepted and in progress
- T_v CR LF** - command comprehended but tare range overflow appeared
- T_A CR LF** - command accepted and in progress
- T_E CR LF** - time limit for stable result exceeded
- T_I CR LF** - command comprehended but cannot be executed

21.4.3. Get tare value

Syntax: **OT CR LF**

Possible answers:

- OT_TARA CR LF** - command executed

Frame format:

1	2	3	4	5-6	7-15	16	17	18	19	20	21
T	O	space	stability	space	tare	space	unit			CR	LF

- Tare** - 9 characters with decimal point justified to the right
- Unit** - 3 characters justified to the left

21.4.4. Set tare value

Syntax: **UT_TARE CR LF**, where **TARE** – tare value

Possible answers:

- UT_OK CR LF** - command executed
- UT_I CR LF** - command comprehended but cannot be executed
- ES CR LF** - command not recognised (possible wrong tare format)

Notice:

This protocol uses the dot character as a decimal point for separating the decimal fraction part.

21.4.5. Send the stable result in basic unit

Syntax: **S CR LF**

Possible answers:

- S_A CR LF** - command accepted and in progress
- S_E CR LF** - time limit for stable result exceeded
- S_I CR LF** - command comprehended but cannot be executed
- S_A CR LF** - command accepted and in progress
- MASS FRAME** - mass value in basic unit is returned

Frame format:

1	2-3	4	5	6	7-15	16	17	18	19	20	21
S	space	stability	space	sign	mass	space	unit		CR	LF	

Example:

S CR LF – computer command

S _ A CR LF - command accepted and in progress

S _ _ _ _ - _ _ _ _ _ 8 . 5 _ g _ _ CR LF – command done,
mass value in basic unit is returned.

21.4.6. Send the result immediately in basic unit

Syntax: **SI CR LF**

Possible answers:

- SI_I CR LF** - command comprehended but cannot be executed at the moment
- MASS FRAME** - mass value in basic unit is returned

Frame format:

1	2	3	4	5	6	7-15	16	17	18	19	20	21
S	I	space	stability	space	sign	mass	space	unit			CR	LF

Example:

S I CR LF – computer command

S I _ ? _ _ _ _ _ 1 8 . 5 _ k g _ CR LF - command done, mass value in basic unit is returned immediately.

21.4.7. Send the stable result in current unit

Syntax: **SU CR LF**

Possible answers:

SU_A CR LF - command accepted and in progress

SU_E CR LF - timeout while waiting for stable results

SU_I CR LF - command comprehended but cannot be executed

SU_A CR LF - command accepted and in progress

MASS FRAME - mass value in current unit is returned

Frame format:

1	2	3	4	5	6	7-15	16	17	18	19	20	21
S	U	space	stability	space	sign	mass	space	unit			CR	LF

Example:

S U CR LF – computer command

S U _ A CR LF - command accepted and in progress

S U _ _ _ - _ _ 1 7 2 . 1 3 5 _ N _ _ CR LF - command done, mass value in current unit is returned.

21.4.8. Send the result immediately in current unit

Syntax: **SUI CR LF**

Possible answers:

- SUI CR LF** - command comprehended but cannot be executed
- MASS FRAME** - mass value in current unit is returned immediately

Frame format:

1	2	3	4	5	6	7-15	16	17	18	19	20	21
S	U	I	stability	space	sign	mass	space	unit			CR	LF

Example:

SUI CR LF – computer command

SUI? _ - _ _ _ 5 8 . 2 3 7 _ k g _ CR LF - command executed and mass returned

21.4.9. Switch on continuous transmission in basic unit

Syntax: **C1 CR LF**

Possible answers:

- C1_I CR LF** - command comprehended but cannot be executed
- C1_A CR LF** - command comprehended and in progress
- MASS FRAME** - mass value in basic unit is returned

Frame format:

1	2	3	4	5	6	7-15	16	17	18	19	20	21
S	I	space	stability	space	sign	mass	space	unit			CR	LF

21.4.10. Switch off continuous transmission in basic unit

Syntax: **C0 CR LF**

Possible answers:

- C0_I CR LF** - command comprehended but cannot be executed
- C0_A CR LF** - command comprehended and executed

21.4.11. Switch on continuous transmission in current unit

Syntax: **CU1 CR LF**

Possible answers:

CU1_I CR LF - command comprehended but cannot be executed

CU1_A CR LF - command comprehended and in progress

MASS FRAME - mass value in current unit is returned

Frame format:

1	2	3	4	5	6	7-15	16	17	18	19	20	21
S	U	I	stability	space	sign	mass	space	unit			CR	LF

21.4.12. Switch off continuous transmission in current unit

Syntax: **CU0 CR LF**

Possible answers:

CU0_I CR LF - command comprehended but cannot be executed

CU0_A CR LF - command comprehended and executed

21.4.13. Lock the scale keyboard

Syntax: **K1 CR LF**

Possible answers:

K1_I CR LF - command comprehended but cannot be executed

K1_OK CR LF - command executed

Caution:

This command is not remembered after restart

21.4.14. Unlock the scale keyboard

Syntax: **K0 CR LF**

Possible answers: **K0_OK CR LF** – command in progress

21.4.15. Give serial number

Syntax: **NB CR LF**

Possible answers:

NB_A_”Factory number” CR LF - command comprehended, scale serial number is given in return

NB_I CR LF - command comprehended but cannot be executed

”Factory number” – parameter specifying scales serial number, it is returned in between inverted comas.

Example:

NB CR LF – command from a computer

NB_A_”123456” CR LF – scales serial number - 123456

21.4.16. Send all implemented commands

Syntax: **PC CR LF**

Possible answers:

PC_->_Z,T,S,SI,SU,SUI,C1,C0,CU1,CU0,K1,K0,OT,UT,NB,PC

– command executed, the indicator have sent all the implemented commands.

21.5. Manual printouts / automatic printouts

Users can general manual or automatic printouts from the scale.

- Manual printouts can be performed after loading the pan and stabilizing indication by pressing .

- Automatic printouts can be performed only after loading the pan and stabilizing indication.

Notice:

If a scale is verified printouts of immediate values are blocked.

Format frame:

1	2	3	4 -12	13	14	15	16	17	18
stability	space	sign	mass	space	unit			CR	LF

Stability character [space] if stable
 [?] if not stable
 [^] if an indication over the range
 [v] if fan indication below the range

sign [space] for positive values or
 [-] for negative values

mass 9 characters justified to the right

unit 3 characters justified to the left

command 3 characters justified to the left

Example 1:

_____ **1 8 3 2 . 0 _ g _ _ CR LF** – the printout generated from the scale after pressing ENTER/PRINT.

Example 2:

? _ - _____ **2 . 2 3 7 _ l b _ CR LF** - the printout generated from the scale after pressing ENTER/PRINT.

Example 3:

^ _____ **0 . 0 0 0 _ k g _ CR LF** - the printout generated from the scale after pressing ENTER/PRINT.

21.6. Continuous transmission

The indicator can work in a continuous transmission mode. It can be switched on or off in parameters or using RS232 commands.

The frame format sent by the indicator in case of setting <P2.Prnt> to **CntA**:

1	2	3	4	5	6	7-15	16	17	18	19	20	21
S	I	space	stability	space	sign	mass	space	Unit			CR	LF

- Stability character** [space] if stable
[?] if not stable
[^] if an indication over the range
[v] if fan indication below the range
- sign** [space] for positive values or
[-] for negative values
- mass** 9 characters justified to the right
- unit** 3 characters justified to the left
- command** 3 characters justified to the left

The frame format sent by the indicator in case of setting <P2.Prnt> to **Cntb**:

1	2	3	4	5	6	7-15	16	17	18	19	20	21
S	U	I	stability	space	sign	mass	space	unit			CR	LF

21.7. Configuring printouts

General information

If some information included are redundant or not sufficient and there is a necessity of changes one can design their own protocol format in **EDYTOR WAG** computer program. This piece of software is accessible in: <http://www.radwag.com>

22. ERROR COMMANDS

- Err2** - Value beyond the zero range
- Err3** - Value beyond the tare range
- Err4** - Calibration mass or start mass beyond the acceptable range ($\pm 1\%$ for weight, ± 10 for start mass)
- Err5** - Mass of a single piece lower than the scale division
- Err8** - Exceeded the time for tarring, zeroing, start mass adjustment or span adjustment
- Err9** - Time for internal weight lifting/dropping down exceeded (refers to WLC.../C/2 scales)
- NULL** - Zero value from the AD converter
- FULL2** - Measurement range overflow
- LH** - Start mass error, the mass on the weighing platform is beyond the acceptable range (-5% to +15% of start mass)
- 5-FULL** - Display range overflow in totalizing

Notice:

1. Errors: **Err2, Err3, Err4, Err5, Err8, Err9, null**, that appear on the display are also signalled by a short beep sound (about 1 sec.);
2. Error **FULL2** that appears on the display is also signalled by a continuous sound until the cause of error disappears.

23. TECHNICAL PARAMETERS

23.1. Precisions scales of WLC series

Scale type:	WLC 1/A2	WLC 2/A2	WLC 6/A2
		-	-
Max capacity	1kg	2kg	6kg
Min capacity	-	-	5g
Reading division [d]	0,01g	0,01g	0,1g
Verification interval [e]	-	-	1g
Range of tare	-1kg	-2kg	-6kg
Repeatability	0,03g	0,03g	0,1g
Linearity	±0,03g	±0,03g	±0,1g
Pan size	195x195mm		
Stabilization time	3 sec		
Operation temperature	+15°C to +30°C		
Atmospheric humidity	10÷85% RH no condensation		
Ingress protection rating	IP43		
Power supply	11V AC, 10,5÷15V DC, I _{max} =600mA and battery		
Display	LCD (with backlight)		
Supplied from batteries	45h (average time)		
Net / Gross weight	2,8/4,3kg		
Package dimensions	470x380x336mm		

Scale type:	WLC 10/A2	WLC 20/A2
		-
Max capacity	10kg	20kg
Min capacity	-	-
Reading division [d]	0,1g	0,1g
Verification interval [e]	-	-
Range of tare	-10kg	-20kg
Repeatability	0,3g	0,3g
Linearity	±0,3g	±0,3g
Pan size	195x195mm	
Stabilization time	3 sec	
Operation temperature	+15°C to +30°C	
Atmospheric humidity	10÷85% RH no condensation	
Ingress protection rating	IP43	
Power supply	11V AC, 10,5÷15V DC, I _{max} =600mA and battery	
Display	LCD (with backlight)	
Supplied from batteries	45h (average time)	
Net / Gross weight	2,8/4,3kg	
Package dimensions	470x380x336mm	

Scale type:	WLC 6/F1/R	WLC 12/F1/R	WLC 30/F1/R
	WLC 6/F1/K	WLC12/F1/K	WLC 30/F1/K
	M 16	-	
Max capacity	6kg	12kg	30kg
Min capacity	5g	-	-
Reading division [d]	0,1g	0,2g	0,5g
Verification interval [e]	1g	-	-
Range of tare	-6kg	-12kg	-30kg
Repeatability	0,3g	0,6g	1,5g
Linearity	±0,3g	±0,6g	±1,5g
Pan size	300x300mm		
Stabilization time	3 sec		
Operation temperature	+15°C to +30°C		
Atmospheric humidity	10÷85% RH no condensation		
Ingress protection rating	IP43		
Power supply	11V AC, 10,5÷15V DC, I _{max} =600mA and battery		
Display	LCD (with backlight)		
Supplied from batteries	35h (average time)		
Net / Gross weight	5,2/6kg		
Package dimensions	570x390x170mm		

Scale type:	WLC 60/C2/R	WLC 120/C2/R
	WLC 60/C2/K	WLC 120/C2/K
	M 16	-
Max capacity	60kg	120kg
Min capacity	50g	-
Reading division [d]	1g	2g
Verification interval [e]	10g	-
Range of tare	-60kg	-120kg
Repeatability	1g	2g
Linearity	±1g	±2g
Pan size	400x500mm	
Stabilization time	3 sec	
Operation temperature	+15°C to +30°C	
Atmospheric humidity	10÷85% RH no condensation	
Ingress protection rating	IP43	
Power supply	11V AC, 10,5÷15V DC, I _{max} =600mA and battery	
Display	LCD (with backlight)	
Supplied from batteries	35h (average time)	
Net / Gross weight	12,5/15kg	
Package dimensions	720x580x220mm	

23.2. Precise scales of WLC../C/2 series

Scale type:	WLC 0,6/A1/C/2	WLC 1/A2/C/2	WLC 6/A2/C/2
		M 16	-
Max capacity	0,6kg	1kg	6kg
Min capacity	0,5g	-	5g
Reading division [d]	0,01g	0,01g	0,1g
Verification interval [e]	0,1g	-	1g
Range of tare	-0,6kg	-1kg	-6kg
Repeatability	0,02g	0,03g	0,2g
Linearity	±0,02g	±0,03g	±0,2g
Pan size	128x128mm	195x195mm	
Stabilization time	3 sec		
Operation temperature	+15°C to +30°C		
Atmospheric humidity	10÷85% RH no condensation		
Ingress protection rating	IP43		
Power supply	11V AC, 10,5÷15V DC, I _{max} =600mA and battery		
Adjustment/Calibration	internal (automatic)		
Display	LCD (with backlight)		
Supplied from batteries	45h (average time)		
Net / Gross weight	3,6/5,6kg		
Package dimensions	470x380x336mm		

24. TROUBLE SHOOTING

Problem	Cause	Solution
Turning on does not work	Discharged batteries.	Connect to mains or change batteries
	No batteries (not installed or improperly installed)	Check the correctness of installation (polarization)
The scale turns off automatically	„t1” set to „YES” (Power save)	In „othr” submenu change „5.4 t1” to „no”
After turning on „LH” message on the display	Loaded weight pan during powering up	Unload the pan. Then the scale will indicator zero.

25. ADDITIONAL EQUIPMENT

Accessories:

- Computer cable - **P0108**,
- EPSON printer cable - **P0151**,
- Power cord for car lighter 12V DC - **K0047**,
- Thermal printer - **EPSON**,
- Dot matrix printer - **EPSON**,
- Additional display in plastic casing for WLC/A, WLC/F1, WLC/C2 scales - **WD- 4/1** (accessible with balance as complete set only),
- Current loop in plastic casing - **AP2-1**,
- RS232 / RS485 converter for PUE C/31 – **KR-01**,
- RS232 / Ethernet converter for PUE C/31 - **KR-04-1**,
- Stainless steel vibration damping table- **SAL/STONE/H**,
- Milded steel vibration damping table- **SAL/STONE/C**,
- Mass standards with accessories,
- A frame for weighings loads under a scale of WLC/A2, WLC/A2/C/2 series.

Computer programs:

- "EDYTOR WAG" computer program,
- "RAD-KEY" computer program,
- "PW-WIN" computer program.



RADWAG BALANCES AND SCALES

ADVANCED WEIGHING TECHNOLOGIES

