



Listed as intrinsically safe by Underwriters Laboratories. UL is a Nationally Recognized Testing Laboratory (NRTL).



CSA International, certification that a product meets applicable Canadian standards. CSA International is a Nationally Recognized Testing Laboratory (NRTL).



Intertek ETL SEMKO, certification that a product meets applicable U.S. standards. Intertek ETL SEMKO is a Nationally Recognized Testing Laboratory (NRTL).



Equipment and protective systems intended for use in potentially explosive atmospheres that are certified as meeting the essential health and safety requirements of the European ATEX Directive 2014/34/EU.



Equipment that meets the essential health and safety requirements of all applicable European Product Directives including:
ATEX – equipment safety in explosive atmospheres - 2014/34/EU
MD – machinery safety - 2006/42/EC
LVD – electrical safety - 2014/35/EU
EMC – electromagnetic compatibility - 2014/30/EU
RoHS – restriction of the use of certain hazardous substance in electrical and electronic equipment - 2011/65/EU.



Tested and certified by Mine Safety and Health Administration as intrinsically safe

IECEX

International Electrotechnical Commission, equipment that has been independently certified to conform to international standards covering Ex equipment and services for associated equipment and installations in explosive atmospheres



ISO 9001

An ISO 9001 registered company, SKC's management and production procedures adhere to this international quality standard.

Sample Pumps & Accessories4-35

Personal	5
High Flow	22

Gas & Vapor Sampling36-86

Sorbent Tubes	36
Sample Bags	52
Coated Filters	64
Impingers	67
Passive Samplers	68

Particulate Sampling.....87-117

Filters	87
Particulate Sampler Selection Guide	106
Size-selective Samplers	108-117

Bioaerosol Sampling118-125

Portable Instruments.....126-136

Particulates	127
Indoor Environmental Quality	132
Ambient Air Quality.....	134

Surface/Dermal Sampling.....137-142

Sampling Guides143-213



SKCONNECT

skcinc.com



SKCairsampling



SKCSamplers



SKCInc1



Company/skc-inc-

**Join our community,
get FREE resources.**

- *Technical tips*
- *Training webinars*
- *Videos and presentations*
- *Agency updates*
- *New methods and media*

skcinc.com

New!

from SKC

rocket pump TOUCH Sample Pump

A whole new take on low flow sampling!
Get touch screen operation and more.

See pages 12-13.



SKC Diffusive TD Tubes

for BTEX/Other VOCs

See pages 48-49.

SKC All-in-One Low Flow Holder

One lightweight unit for simpler single-tube low flow
sampling trains

See page 50.



chek-mate Calibrator

Check out this highly accurate calibrator for personal
sample pumps!

See pages 32-33.

SKC Air Sample Pumps

The Professional's Choice for Quality and Durability



SKC is the **professional's choice** in air sample pumps for health and safety applications. SKC on the outside means over 50 years of innovation and reliability on the inside. SKC pumps are available with a choice of flow rates, features, interfaces, and accessories. All are built with quality and backed by service and support.

20 to 500 ml/min	
Pocket Pump TOUCH New!	12-13
5 to 3000 ml/min	
AirChek 52/Sidekick	18-19
AirChek 3000	20-21
AirLite	29
5 to 5000 ml/min	
AirChek TOUCH New!	8-10
AirChek XR5000	14-15
Universal XR Series	16-17
5 to 15 L/min	
Leland Legacy	22-23
Deployable Systems	24-25
Flows to 30 L/min	
QuickTake 30	26-27
Flite 3	28
Vac-U-Go/BioLite	123

SKC Sample Pump Selection Guide

Choose the Features You Need, Get the Quality You Expect

Choose by Flow Range	20 to 500 ml/min	5 to 3000 ml/min	5 to 5000 ml/min	5 to 15 L/min
-----------------------------	------------------	------------------	------------------	---------------

Choose by Compensation Range	Up to 20 inches water BP at 500 ml	Up to 30 inches water BP at 2 liters	Up to 25 inches water BP at 2 liters	Up to 20 inches water BP at 2 liters	Up to 40 inches water BP at 2 liters	Up to 50 inches water BP at 2 liters	Up to 50 inches water BP at 2 liters	Up to 12 inches water BP at 10 liters
-------------------------------------	------------------------------------	--------------------------------------	--------------------------------------	--------------------------------------	--------------------------------------	--------------------------------------	--------------------------------------	---------------------------------------

Choose by Feature								
Programmable/PC Compatible	Keypad/PC	Keypad/PC	No	No	Keypad (PCXR8)	Keypad	Keypad/PC	Keypad/PC
Listed for Intrinsic Safety	UL	Ex	UL	No	UL	UL	UL	No
Compensates for Changes in Atmospheric Pressure	Yes	Yes	No	No	No	No	Yes	Yes
Compensates for Changes in Temperature	Yes	Yes	No	Yes	No	Yes	Yes	Yes
Battery Type	Li-Ion	NiMH	NiMH	Alkaline	NiMH	Li-Ion	Li-Ion	Li-Ion
Approximate Run Time	20+ hours at 200 ml/min	12+ hours at 2 L/min	12+ hours at 2 L/min	10+ hours at 2 L/min	12+ hours at 4 L/min	20 hours at 2 L/min	20 hours at 2 L/min	24+ hours at 10 L/min

New!



Pocket Pump TOUCH
Pages 12-13



AirChek 3000
Pages 20-21



AirChek 52/Sidekick
Pages 18-19



AirLite
Page 29



Universal XR
Pages 16-17



AirChek XR5000
Pages 14-15



AirChek TOUCH
Pages 8-10

New!



Leland Legacy
Pages 22-23

Air Sampling Pump Kits from SKC Inc. With Accessories for U.S. Methods

Don't Forget . . .

SKC Air Sampling Kits provide the pumps and accessories you need for your applications. Order the following items separately:

- ☑ **A calibration device** – Select a calibration device based on the accuracy requirements of your application. See pages 32-34.
- ☑ **Sampling Media** – Base your choice of sampling media on the application and the method used. Consult the SKC Comprehensive Air Sampling Guide for information on recommended sampling media for specific compounds. See sampling media beginning on page 36.

SKC Inc. carefully designs its air sampling pump kits to meet the unique sampling requirements of individual regions. When selecting a pump kit, consider the configuration that will best fit your application. Most of the SKC Inc. pumps are available in Starter Kits with pump, tubing, and charger; single kits (one of each kit component); and 5-pack kits (5 of each kit component except the charger and the case). Kits do **not** include sample media or a calibrator (unless otherwise noted). Kit content can vary depending on the pump model.

Starter Kits

- Pump
- Battery charger
- Tubing
- Collar clip with cable tie



High Flow Sampling Kits

- Pump
- Battery charger
- Filter cassette holder
- Tubing
- Screwdriver set
- Soft-side nylon carry case (single) or Pelican case (5 pack)



Low and High Flow Sampling Kits

- Pump
- Battery charger
- Filter cassette holder
- Tubing
- All-in-One low flow holder
- Type A tube cover
- Screwdriver set
- Soft-side nylon carry case (single) or Pelican case (5 pack)



Low Flow Sampling Kits

- Pump
- Battery charger
- Type A tube holder
- Tubing
- Soft-side nylon carry case (single) or Pelican case (5 pack)



See specific pump pages for ordering information.

Air Sampling Pump Kits from SKC Ltd. With Accessories for Euro Methods

SKC Ltd. air sampling pump kits are designed to suit your applications without a lot of extra purchases. One durable carry case houses the equipment you need for gas/vapour sampling, dust/particulate sampling, or both. A basic kit is available to which you may add equipment for specific applications. Kits are available in single and 5-pack configurations. Kits do **not** include a calibrator or sample media. Contents of kits may vary with pump model.

Basic Air Sampling Kits

- Pump
- Battery charger
- Tubing
- Screwdriver set
- Step by Step Guide
- Durable carry case



Gas/Vapour Sampling Kits

- Pump
- Battery charger
- Tubing
- Tube breaker
- All-in-One low flow holder* **New!**
- Type A protective tube cover
- Screwdriver set
- Step by Step Guide
- Durable carry case



Dust/Particulate Sampling Kits

- Pump
- Battery charger
- Tubing
- IOM Sampler (plastic)
- IOM Cassettes (4, plastic)
- Calidaptor
- 25-mm Plastic Cyclone
- 25-mm Cyclone cassettes (4)
- Screwdriver set
- Step by Step Guide
- Durable carry case



Combined Dust and Vapour Sampling System

- Pump
- Battery charger
- Tubing
- Tube breaker
- All-in-One low flow holder
- Type A protective tube cover
- Calidaptor
- IOM Sampler (plastic)
- IOM Cassettes (4, plastic)
- 25-mm Plastic Cyclone
- 25-mm Cyclone cassettes (4)
- Screwdriver set
- Step by Step Guide
- Large, durable carry case



Personal Pump Guide.....	5
AirChek TOUCH	10
DataTrac Software	11
Pocket Pump TOUCH	12-13
AirChek XR5000	14-15
Universal Pumps.....	16-17
AirChek 52/Sidekick	18-19
AirChek 3000	20-21
Leland Legacy	22-23
Deployable Systems	24-25
QuickTake 30	26-27
Flite 3	28
AirLite	29
Battery Chargers.....	30-31
Calibrators	32-34
Tubing/Pump Cases.....	35
Vac-U-Go/BioLite.....	123



* Not included in Pocket Pump TOUCH Kits

See specific pump pages for ordering information.

New!

AirChek[®] TOUCH

Sample Pump

Intuitive

Powerful

Versatile



AirChek TOUCH

- ▶ **Extended flows from 5 to 5000 ml/min**
 - 5 to 500 ml/min with low flow holder, *see page 48*
 - Multi-tube sampling in low flow mode
- ▶ **Color touch screen navigation, easy programming**
- ▶ **Continuous, timed, and intermittent sampling**
- ▶ **High back pressure compensation**
(50 inches water at 2 L/min)
- ▶ **Powerful Li-Ion battery for up to 20 hours at 2 L/min**
- ▶ **Corrects flow for changes in temperature and atmospheric pressure**
- ▶ **Screen protection and security**
 - Protective cover
 - Screen lock-out feature
- ▶ **Ultra quiet — average 51.7 dB at 3 feet**
(37-mm, 0.8 µm MCE filter at 2 L/min)
- ▶ **New DataTrac Pro PC Software for easy pump and data management** (*see page 11*)
- ▶ **Small and lightweight**
 - 4.1 x 3.7 x 2.8 inches
 - 19.4 ounces



See Ordering on page 10.

AirChek TOUCH

Ordering

Description	Cat. No.
AirChek TOUCH Pump with Li-Ion battery pack and screwdriver set, <i>requires charging cradle and power supply; see below</i>	220-5000TC

AirChek TOUCH Pump Kits	SKC Inc. Cat. No.	SKC Ltd. Cat. No.
Starter Kit includes pump as described above, Standard Charging Cradle, power supply with cord, 0.9 meter (3 feet) of Tygon tubing, and collar clip with cable tie	220-5000TC-S	220-5000TCK
Single High Flow Pump Kit includes pump as described above, Standard Charging Cradle, power supply with cord, and filter cassette holder, in a soft-side nylon carry case	220-5000TC-K	
Single Combined Kit includes pump as described above, Standard Charging Cradle, power supply with cord, plastic IOM MultiDust Sampler, 5 Multidust cassettes, plastic cyclone, 5 cyclone cassettes, All-In-One low flow holder, Type A protective tube cover, tube breaker, calidaptor and 1 meter of Tygon tubing, in a durable carry case		220-5000TCKC
Single High/Low Flow Pump Kit includes pump as described above, Standard Charging Cradle, power supply with cord, filter cassette holder, All-in-One low flow holder, and Type A protective tube cover, in a soft-side nylon carry case	220-5000TC-KD	
Single High/Low Flow Enhanced Pump Kit includes pump as described above, Enhanced Charging Cradle (e-Cradle), power supply with cord, USB cable, filter cassette holder, All-in-One low flow holder, and Type A protective tube cover, in a soft-side nylon carry case	220-5000TC-KDE	
Single Dust Kit includes pump as described above, Standard Charging Cradle, power supply with cord, plastic IOM MultiDust sampler, 5 Multidust cassettes, plastic cyclone, 5 cyclone cassettes, calidaptor, and 1 meter of Tygon tubing, in a durable carry case		220-5000TCKP
Single Pump Vapour Kit includes pumps as described above, Standard Charging Cradle, power supply with cord, All-In-One low flow holder, Type A protective tube cover, tube breaker, and 1 meter of Tygon tubing, in a durable carry case		220-5000TCKV
3-pack High/Low Flow Pump Kit includes 3 pumps as described above, 2 Standard Charging Cradles, 1 e-Cradle, power supply with cord, and USB cable, 3 each: filter cassette holders, All-in-One low flow holders, and Type A protective tube covers, in a Pelican case	220-5000TC-K3D	
5-pack High Flow Pump Kit includes 5 pumps as described above, 4 Standard Charging Cradles, 1 e-Cradle, power supply with cord, USB cable, and 5 filter cassette holders, in a Pelican case	220-5000TC-K5	220-5000TCK5
5-pack High/Low Flow Pump Kit includes 5 pumps as described above, 4 Standard Charging Cradles, 1 e-Cradle, power supply with cord, and USB cable, 5 each: filter cassette holders, All-in-One low flow holders, and Type A protective tube covers, in a Pelican case	220-5000TC-K5D	
5-Pump Combined Kit includes 5 pumps as described above, 4 Standard Charging Cradles, 1 Charging e-Cradle, power supply with cord, 5 plastic IOM MultiDust samplers, 10 Multidust cassettes, 5 plastic cyclones, 10 cyclone cassettes, calidaptor, 5 All-In-One low flow holders, 5 Type A protective tube covers, tube breaker, and 5 x 1 meter of Tygon tubing, in a durable carry case		220-5000TCK5C
5-Pump Dust Kit includes 5 pumps as described above, 4 Standard Charging Cradles, 1 Charging e-Cradle, power supply with cord, 5 plastic IOM MultiDust samplers, 10 Multidust cassettes, 5 plastic cyclones, 10 cyclone cassettes, calidaptor, and 5 x 1 meter of Tygon tubing, in a durable carry case		220-5000TCK5P
5-Pump Vapour Kit includes 5 pumps as described above, 4 Standard Charging Cradles, 1 Charging e-Cradle, power supply with cord, 5 All-In-One low flow holders, 5 Type A protective tube covers, tube breaker, and 5 x 1 meter of Tygon tubing, in a durable carry case		220-5000TCK5V

Accessories	Cat. No.
Standard Charging Cradle , <i>requires power supply, see below</i>	220-800
Enhanced Charging Cradle (e-Cradle) includes USB cable, <i>requires power supply, see below</i>	220-900
Single Cradle Power Supply , for use with one charging cradle	220-600
Multi Cradle Power Supply , for use with 2 to 5 charging cradles	220-700
DataTrac Pro for AirChek TOUCH Hardware Accessory Kit includes e-Cradle, USB cable, and single power supply	877-93
Low Flow (5 to 500 ml/min) Adapter Kit includes All-in-One low flow holder and Type A tube cover	210-500
CalChek Communication Cable , for use with Defender calibrator	210-502
Replacement Battery Pack , Li-Ion	P75718
Protective Pouch , nylon, with adjustable waist belt and shoulder strap, black	224-911

AirChek TOUCH requires 1/4-inch ID tubing; see page 35. 

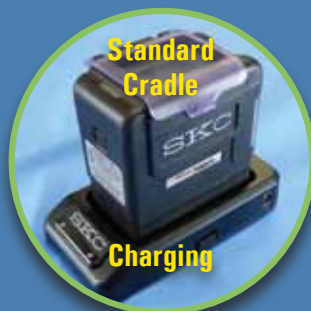

Certifications



DataTracPro

Management Software for AirChek TOUCH and Pocket Pump TOUCH

DataTrac Pro Software is a time-saving pump and data management accessory for your AirChek **TOUCH** and Pocket Pump **TOUCH** sample pumps. Use DataTrac Pro's intuitive tabs to access/manage pump history, control/monitor pump operation, program sample run presets, and configure pump settings for your applications.

Set up a fleet of pumps quickly

Program sample run for upload to pumps

Easily update firmware and settings

See graphical display of sampling events

Connect multiple pumps via cradle

View downloaded pump history at a glance

Save and export sampling data for reporting

Sample from Pump 10004 on 10/29/2015 at 2:04 PM

L/min

0.25

0.00

00:00 00:01 00:02 00:03 00:04 00:05

Status	Start	Duration	Rate	Accu. Vol.	STP Vol.	Temp.	Atm. Pressure
Run	10/29/2015 2:04:26 PM	00:01	1.99 L/min	3.99 L		75.8°F	28.58 inHg
Fault	10/29/2015 2:06:11 PM	00:03	1.76 L/min	6.93 L		75.8°F	28.58 inHg
Total		00:05		10.99 L	10.90 L	75.8°F	28.56 inHg

Export Data

Save Summary

Viewing:

Pump	Start	Set Rate	Duration	Run Time	Accum. Vol.	Type	Notes
10004	10/29/2015 2:04 PM	2.50 L/min	00:05	00:04	18.95 L		Fault
10004	10/29/2015 2:04 PM	2.50 L/min	00:00	00:00	0.54 L		
10004	10/29/2015 1:59 PM	2.00 L/min	00:03	00:03	2.81 L		Fault
10004	10/29/2015 1:58 PM	1.50 L/min	00:00	00:00	0.45 L		
10004	10/29/2015 8:31 AM	1.50 L/min	00:01	00:01	1.64 L		

DataTrac Pro for AirChek TOUCH

DataTrac Pro-AirChek TOUCH Hardware Accessory Kit includes e-Cradle, single power supply, and USB cable. *DataTrac Pro software is available at no charge for download. AirChek TOUCH Pump, PC, and DataTrac Pro Software are required; see www.skcinc.com for system/hardware specifications.*



Easy cradle and USB connection to PC

Cat. No. 877-93

DataTrac Pro for Pocket Pump TOUCH

DataTrac Pro-Pocket Pump TOUCH USB Bluetooth Adapter fits in USB port on PC, required when using *DataTrac Pro* for Pocket Pump **TOUCH**. *DataTrac Pro software is available at no charge for download. Pocket Pump TOUCH, PC, and DataTrac Pro Software are required; see www.skcinc.com for system/hardware specifications.*



Convenient Bluetooth connection to PC with adapter

Cat. No. 877-94

New! Rocket Pump® TOUCH

Get the Low Flow TOUCH in Air Sampling

- Intuitive touch screen for easy programmability
- Constant flows from 20 to 500 ml/min
 - Accommodates typical flow rates for sorbent tubes
 - Port and quick-connect accessory for bag sampling
- Bluetooth communication with PC and DataTrac Pro Software (see page 13 for details)
- Magnetic charging connector
- Constant battery status display
- Time, date, battery status, flow rate, sample volume, temperature, atmospheric pressure, remaining run time (programmed run), and elapsed run time displayed on large backlit screen
- Rubber overmolding on case provides for quiet operation, impact protection, and a no-slip grip
- Compact and only 232 grams (8.2 ounces)
- > 20-hour run times at 200 ml/min with powerful Li-Ion battery
 - Auto-dim feature conserves battery
 - Extended run times with AC adapter/charger
- Multi-tube sampling
 - Sample with up to 4 tubes simultaneously; saves time and uses fewer pumps
 - Constant flow mode with multiple-tube low flow holder and CPC (see page 51)
 - Constant pressure mode with multiple-tube low flow holder only (see page 51)
- Automatic flow fault and restart
- Screen auto-lock provides for secure sampling





Magnetic charging connector with sure-connect indicator light



Large backlit screen

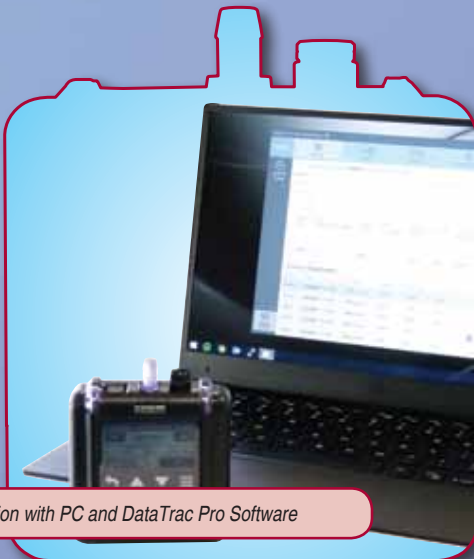

Bluetooth communication with PC and DataTrac Pro Software



Port with quick-connect accessory for easy bag sampling

Description	Cat. No.
Pocket Pump TOUCH only* with Li-Ion battery and screwdriver, <i>requires charger; see kits or chargers below</i>	220-1000TC
Pocket Pump TOUCH with Charger* includes pump as described above and single USB charger with magnetic connector and wall plug (U.S.)	220-1000TC-C
Pocket Pump TOUCH Starter Kit* includes pump, single charger, 0.9 meter (3 feet) of Tygon tubing, and collar clip with cable tie	220-1000TC-S
Single Pump Kit** includes pump as described above, single charger, and Type A single tube holder, in a soft-sided nylon carry case†	220-1000TC-K
5-pack Pump Kit* includes 5 pumps as described above, 5 Type A single tube holders, and one 5-port USB charging hub with power cable (U.S. plug), in a Pelican case	220-1000TC-K5D

Accessories	Cat. No.
Single Charger , USB, with U.S. plug	220-300
5-port USB Charging HUB with power cable (U.S. plug)	220-400
Replacement Battery Pack** Li-Ion	P76303
Quick-connect Bag Sampling Adapter , installs on pump exhaust port for quick connection to tubing for bag sampling	220-200
Single Kit Case , nylon, with shoulder strap	224-903
5-pack Kit Case , Pelican	224-915
DataTrac Pro for Pocket Pump TOUCH includes USB Bluetooth adapter	877-94

* Pocket Pump TOUCH pumps with Li-Ion batteries may be subject to special shipping regulations.

† Single kits are also available in hard-sided Pelican case. Contact SKC.

‡ Replacing batteries with non-approved battery packs voids any warranty and UL Listing for intrinsic safety.

Pocket Pump TOUCH requires 1/4-inch ID tubing; see page 35.

AirChek XR5000

High Power, Low Price

- **Extended flow range: 5 to 5000 ml/min†**
 - Suitable for low flow gas/vapor or high flow particulate sampling
 - Multi-tube sampling option allows up to four tube samples to be taken simultaneously, each at different flow rates if desired
- **Extended back pressure capabilities**
 - Up to 50 inches of water at 2 L/min
- **2 interchangeable battery options**
 - High-power Li-Ion for extended runs
 - Standard Li-Ion for lighter weight
- **Highly accurate electronic flow control system‡**
- **Automatic flow correction for changes in temperature provides accurate air volumes**
- **Extremely simple operation**
 - Large three-button keypad
 - Continuous run with the push of a button
 - Bright blue pump status LED
 - Easy-to-read LCD displays elapsed time and accumulated run time
- **Set-and-go timer**
 - Timed and delayed runs up to 9999 minutes
- **Sample integrity**
 - Lockable keypad
 - Automatic flow fault
 - Auto-restart attempted after 15 seconds in flow fault
- **Standard model weighs only 454 grams (16 ounces)**



Partner with the 4 L/min PPI for higher flow respirable dust sampling
see pages 112-113

† 5 to 500 ml/min with low flow adapter, see pages 50-51
‡ U.S. Patent No. 5,892,160

Certifications

Enhanced Battery Power for Extended Runs!

XR5000 Model	2 L/min*	5 L/min*
High-power Li-Ion	40 hours	22 hours
Standard Li-Ion	20 hours	11 hours

* Results of run time tests using 37-mm, 0.8-µm MCE filters with new pumps and batteries. Pump and battery performance may vary.



Enhanced battery power for extended run times



2 Li-Ion battery options



Blue status LED



Small footprint and only 454 grams!

SKC Inc. AirChek® XR5000 Kits

Description	4-cell High-power Battery Pack SKC Inc. Cat. No.	2-cell Standard Battery Pack SKC Inc. Cat. No.
Pump with battery and screwdriver set, <i>requires charger; see kits below or chargers on pp. 30-31</i>	210-5001	210-5002
Starter Kit includes pump, charger, # 0.9 meter (3 feet) of Tygon tubing, and collar clip with cable tie	210-5001-S	210-5002-S
Single Pump Kit includes pump, charger, cassette holder, and soft-side nylon carry case (224-903)	210-5001K	210-5002K
5-pack High Flow Pump Kit includes 5 pumps and cassette holders and Take Charge 5 Multi-charger (100-240 V), in a Pelican case (224-914)	210-5001K5	210-5002K5
5-pack High/Low Flow Pump Kit includes 5 pumps, cassette holders, All-in-One low flow holders, and Type A protective tube covers and Take Charge 5 Multi-charger (100-240 V), in a Pelican case (224-914)	210-5001K5D	210-5002K5D
Replacement Li-Ion Battery Pack	P85004	P85002

100-240 V

SKC Ltd. AirChek XR5000 Kits

Description	4-cell High-power Battery Pack SKC Ltd. Cat. No.	2-cell Standard Battery Pack SKC Ltd. Cat. No.
Pump with battery , <i>requires charger, see kits below or charger on pp. 30-31</i>	210-5001	210-5002
Single Pump Basic Kit includes pump, charger, # 1 meter (39 inches) of Tygon tubing, and 1 Step by Step Guide, in a durable carry case (224-98)	210-5001K	210-5002K
Single Pump Kit-Gas/Vapour includes pump and battery, single charger (223-241*), 1 meter (39 inches) of Tygon tubing, All-in-One low flow holder (224-27), tube breaker (800-01200), Type A protective tube cover (224-29A), and 1 Step by Step Guide, in a durable carry case (224-98)	210-5001KV	210-5002KV
Single Pump Kit-Dust/Particulate includes pump and battery, single charger (223-241*), calidaptor (391-01), 1 meter (39 inches) of Tygon tubing, plastic IOM MultiDust Sampler (225-70A), 4 extra MultiDust cassettes (225-71A), Plastic Cyclone (225-69), 4 extra cyclone cassettes (225-62), and 1 Step by Step Guide, in a durable carry case (224-98)	210-5001KP	210-5002KP
Single Pump Kit-Combined includes pump and battery and all media and accessories as described in the Single Gas/Vapour and the Single Dust/Particulate kits, in one durable carry case (224-98)	210-5001KC	210-5002KC
5-pack Pump Basic Kit includes 5 each pumps and batteries, 5 one-meter (39-inch) lengths of Tygon tubing, 3 Step by Step Guides, and 5 single chargers, in a durable carry case (224-97B)	210-5001K5	210-5002K5
5-pack Pump Kit-Gas/Vapour includes 5 each pumps and batteries, All-in-One low flow holders (224-27), and Type A protective tube covers (224-29A), 5 one-meter (39-inch) lengths of Tygon tubing, tube breaker (800-01200), 3 Step by Step Guides, and 5 single chargers, # in a durable carry case (224-97B)	210-5001K5V	210-5002K5V
5-pack Pump Kit-Dust/Particulate includes 5 each pumps and batteries, plastic IOM MultiDust Samplers (225-70A), and Plastic Cyclones (225-69), and 5 one-meter (39-inch) lengths of Tygon tubing, 10 extra cyclone cassettes (225-62), calidaptor (391-01), 10 extra MultiDust cassettes (225-71A), 3 Step by Step Guides, and 5 single chargers, # in a durable carry case (224-97B)	210-5001K5P	210-5002K5P
5-pack Pump Kit-Combined includes 5 pumps and batteries and all media and accessories as described in the 5-pack Gas/Vapour and the 5-pack Dust/Particulate kits, in one durable carry case (224-97B)	210-5001K5C	210-5002K5C
Replacement Battery Pack	P85004	P85002

100-240 V

AirChek XR5000 requires 1/4-inch ID tubing, see page 35.

Universal XR Series

5 to 5000 ml/min

Universal XR Series

Classic Workhorse from 5 ml/min to 5 L/min

- ▶ Constant flows from 1 to 5 L/min
- ▶ Low flows with holder from 5 to 500 ml/min
- ▶ Long 12+ hours run time (4 L/min at 20 inches water back pressure)
- ▶ Heavy duty and lightweight – only 964 grams (34 ounces)
- ▶ Compact size
- ▶ Choose the automatic features that meet your requirements



PCXR8 Universal Pump
Programmable Solution



PCXR4 Universal Pump
Compliance Solution



44XR Universal Pump
Economical Solution

- ✓ High-accuracy timer
- ✓ Automatic fault shutdown/
time retention
- ✓ Convenient HOLD feature
- ✓ Delayed start
- ✓ Timed shutdown
- ✓ Intermittent sampling
- ✓ Extended intermittent sampling
up to 7 days

- ✓ High-accuracy timer
- ✓ Automatic fault shutdown/
time retention
- ✓ Convenient HOLD feature

- ✓ Turn on and go

See Ordering on page 17.

Universal XR Pumps, Kits, and Accessories

Description	Voltage	5 to 5000 ml/min SKC Inc. UL Listed	5 to 4000 ml/min SKC Ltd. ATEX approved
Universal Pump with NiMH battery pack and screwdriver set		224-PCXR8 224-PCXR4 224-44XR	224-PCMTX8 224-PCMTX4 224-44MTX
Starter Kit includes pump, single PowerFlex charger (223-2000) with cable (223-1002), 0.9 meter (3 feet) of Tygon tubing, and collar clip with cable tie	100-240 V	224-PCXR8-S 224-PCXR4-S 224-44XR-S	
Single Pump Kit-Basic includes pump as described above, single charger (223-203A), 1 meter (39 inches) of Tygon tubing, and 1 Step by Step Guide, in a durable carry case (224-98)	110-240 V		224-PCMTX8K 224-PCMTX4K 224-44MTXK
Single Pump Kit-High/Low Flow includes pump as described above, single PowerFlex charger (223-2000) with cable (223-1002), filter cassette holder (225-1), adjustable low flow holder (224-26-01), and Type A protective tube cover (224-29A), in a soft-side nylon carry case (224-903)	100-240 V	224-PCXR8KD 224-PCXR4KD 224-44XRKD	
Single Pump Kit-Dust/Particulate includes pump as described above, single charger (223-203A), calidaptor (391-01), 1 meter (39 inches) of Tygon tubing, plastic IOM MultiDust Sampler (225-70A), 4 extra MultiDust cassettes (225-71A), Plastic Cyclone (225-69), 4 extra cyclone cassettes (225-62), and 1 Step by Step Guide, in a durable carry case (224-98)	110-240 V		224-PCMTX8KP 224-PCMTX4KP 224-44MTXKP
Single Pump Kit-Gas/Vapour includes pump as described above, single charger (223-203A), 1 meter (39 inches) of Tygon tubing, single adjustable low flow holder (224-26-01), tube breaker (800-01200), Type A protective tube cover (224-29A), and 1 Step by Step Guide, in a durable carry case (224-98)	110-240 V		224-PCMTX8KV 224-PCMTX4KV 224-44MTXKV
Single Pump Kit-Combined includes pump as described above and all media and accessories as described in the Single Gas/Vapour and the Single Dust/Particulate kits, in one durable carry case (224-98)	110-240 V		224-PCMTX8KC 224-PCMTX4KC 224-44MTXKC
5-pack Pump Kit-Basic includes 5 pumps as described above, 5-station charger (223-103A), 5 one-meter (39-inch) lengths of Tygon tubing, and 3 Step by Step Guides, in a durable carry case (224-97A)	110-240 V		224-PCMTX8K5 224-PCMTX4K5 224-44MTXK5
5-pack Pump Kit-High/Low Flow includes 5 each pumps as described above, single adjustable low flow holders (224-26-01), Type A protective tube covers (224-29A), and filter cassette holders (225-1), and a 5-station PowerFlex charger (223-1000) with 5 cables (223-1002), in a Pelican carry case (224-908)	100-240 V	224-PCXR8K5D 224-PCXR4K5D 224-44XRK5D	
5-pack Pump Kit-Dust/Particulate includes 5 each pumps as described above, plastic IOM MultiDust Samplers (225-70A), and Plastic Cyclones (225-69), 5 one-meter (39-inch) lengths of Tygon tubing, 10 extra cyclone cassettes (225-62), 10 extra MultiDust cassettes (225-71A), calidaptor (391-01), and 3 Step by Step Guides, in a durable carry case (224-97A)	110-240 V		224-PCMTX8K5P 224-PCMTX4K5P 224-44MTXK5P
5-pack Pump Kit-Gas/Vapour includes 5 each pumps as described above, single adjustable low flow holders (224-26-01), and Type A protective tube covers (224-29A), 5 one-meter (39-inch) lengths of Tygon tubing, a 5-station charger (223-103A), tube breaker (800-01200), and 3 Step by Step Guides, in a durable carry case (224-97A)	110-240 V		224-PCMTX8K5V 224-PCMTX4K5V 224-44MTXK5V
5-pack Pump Kit-Combined includes 5 pumps as described above and all media and accessories as described in the 5-pack Gas/Vapour and the 5-pack Dust/Particulate kits, in one durable carry case (224-97A)	110-240 V		224-PCMTX8K5C 224-PCMTX4K5C 224-44MTXK5C

Universal Pumps require 1/4-inch ID tubing; see page 35.

Certifications



See page 105 for the Personal Exposure Vest

Accessories

Tube Holderspages 50-51
Flowmeters.....pages 32-34
Filter Holders.....page 102
Pouches and Kit Cases..... page 35

AirChek 52/Sidekick

5 to 3000 ml/min

ABOUT

Sidekick Sample Pump

The Sidekick is available in three models:

- 224-50MH
- non-ATEX approved
- 224-51MTX
- ATEX approved - no LCD
- 224-52MTX
- ATEX approved with LCD indicator

AirChek 52/Sidekick Small, Simple, Sturdy

The small, lightweight, and economical AirChek® 52/Sidekick Sample Pump is designed for rugged industrial use at flows from 5 to 3000 ml/min. Ideal for on-worker applications, use the compact AirChek 52/Sidekick for short-term or full-shift sampling with sorbent tubes, impingers, size-selective samplers, or filter cassettes. Reliability, ease of use, and precision flow control make the AirChek 52/Sidekick one of the most popular personal air sample pumps in the industry.

Wide flow range

- Constant high flows from 1000 to 3000 ml/min
- Low flows from 5 to 500 ml/min with low flow holder (*see page 50*)
- Ideal for most personal sampling applications

Full-shift run times

- Provides 12+ hours run time at 2 L/min, 25 inches water back pressure

Simple design

- Impact-resistant case is easy to clean and decontaminate
- Easy on/off and flow control
- Quick change battery pack mounted on bottom of pump

Small, compact, and lightweight

- Weighs only 567 grams (20 ounces)

Highly accurate display

- Digital time display tracks sample run time in minutes up to 99,999
- Indicates low battery condition or flow fault without losing sample run time
- Attempts auto-restart up to 5 times from flow fault

Multi-tube sampling saves time and uses fewer pumps

- Multiple low flow tube holder and Constant Pressure Controller (CPC) accessories allow up to four tube samples to be taken simultaneously, each at different flow rates if desired. *See page 51.*

New! All-in-One Low Flow Holder

- Permits single sorbent tube sampling from 5 to 500 ml/min. *See page 50 for details.*





Top view: AirChek 52/Sidekick with LCD indicator

AirChek 52/Sidekick Pumps and Kits

Description	Voltage	AirChek 52 SKC Inc. Cat. No.	Sidekick SKC Ltd. Cat. No.
AirChek 52/Sidekick Pump with NiMH battery pack and screwdriver set		224-52	224-50MH 224-51MTX 224-52MTX
Starter Kit includes pump, PowerFlex charger (223-2000) with cable (223-1004), 0.9 meter (3 feet) of Tygon tubing, and collar clip with cable tie	100-240 V	224-52-S	
Single Pump Kit-Basic includes pump as described above, single charger (223-203A), 1 meter (39 inches) of Tygon tubing, and 1 Step by Step Guide, in a durable carry case (224-98)	110-240 V		224-50MHK 224-51MTXK 224-52MTXK
Single Pump Kit-High Flow includes pump as described above, single PowerFlex charger (223-2000) with cable (223-1004), and filter cassette holder (225-1), in a Pelican carry case (224-901)	100-240 V	224-52KH	
Single Pump Kit-Dust/Particulate includes pump as described above, single charger (223-203A), calidaptor (391-01), 1 meter (39 inches) of Tygon tubing, plastic IOM MultiDust Sampler (225-70A), 4 extra MultiDust cassettes (225-71A), Plastic Cyclone (225-69), 4 extra cyclone cassettes (225-62), and 1 Step by Step Guide, in a durable carry case (224-98)	110-240 V		224-50MHKP 224-51MTXKP 224-52MTXKP
Single Pump Kit-Gas/Vapour includes pump as described above, single charger (223-203A), 1 meter (39 inches) of Tygon tubing, All-in-One low flow holder (224-27), tube breaker (800-01200), Type A protective tube cover (224-29A), and 1 Step by Step Guide, in a durable carry case (224-98)	110-240 V		224-50MHKV 224-51MTXKV 224-52MTXKV
Single Pump Kit-Combined includes pump as described above and all media and accessories as described in the Single Gas/Vapour and the Single Dust/Particulate kits, in one durable carry case (224-98)	110-240 V		224-50MHKC 224-51MTXKC 224-52MTXKC
5-pack Pump Kit-Basic includes 5 pumps as described above, 5-station charger (223-103A), 5 one-meter (39-inch) lengths of Tygon tubing, and 3 Step by Step Guides, in a durable carry case (224-97)	110-240 V		224-50MHK5 224-51MTXK5 224-52MTXK5
5-pack Pump Kit-High Flow includes 5 each pumps as described above and filter cassette holders (225-1), 5-station PowerFlex charger (223-1000) with 5 cables (223-1004), in a Pelican carry case (224-907)	100-240 V	224-52K5	
5-pack Pump Kit-High/Low Flow includes 5 each pumps as described above, All-in-One low flow holders (224-27), Type A protective tube covers (224-29A), and filter cassette holders (225-1), and a 5-station PowerFlex charger (223-1000) with 5 cables (223-1004), in a Pelican carry case (224-907)	100-240 V	224-52K5D	
5-pack Pump Kit-Dust/Particulate includes 5 each pumps as described above, plastic IOM MultiDust Samplers (225-70A), and Plastic Cyclones (225-69), 5 one-meter (39-inch) lengths of Tygon tubing, calidaptor (391-01), 10 extra cyclone cassettes (225-62), 10 extra MultiDust cassettes (225-71A), 5-station charger (223-103A), and 3 Step by Step Guides, in a durable carry case (224-97)	110-240 V		224-50MHK5P 224-51MTXK5P 224-52MTXK5P
5-pack Pump Kit-Gas/Vapour includes 5 each pumps as described above, All-in-One low flow holders (224-27), and Type A protective tube covers (224-29A), 5 one-meter (39-inch) lengths of Tygon tubing, a 5-station charger (223-103A), tube breaker (800-01200), and 3 Step by Step Guides, in a durable carry case (224-97)	110-240 V		224-50MHK5V 224-51MTXK5V 224-52MTXK5V
5-pack Pump Kit-Combined includes 5 pumps as described above and all media and accessories as described in the 5-pack Gas/Vapour and the 5-pack Dust/Particulate kits, in one durable carry case (224-97)	110-240 V		224-50MHK5C 224-51MTXK5C 224-52MTXK5C

The AirChek 52/Sidekick Pump requires 1/4-inch ID tubing, see page 35.

Certifications

(Sidekick models
224-51MTX and 224-52MTX)

For Accessories

- Tube Holderspages 50-51
- Flowmeters.....pages 32-34
- Battery Chargers.....pages 30-31
- Filter Holders..... page 102



More Information
www.skinc.com

Personal Pumps

5 to 3250 ml/min

AirChek 3000

PC Programmable

- ▶ Longer run times with NiMH battery — 12+ hours at 2 L/min, 30 inches water back pressure
- ▶ Advanced flow control from 1000 to 3250 ml/min
 - Accurate internal flow sensor measures flow directly and acts as a secondary standard to maintain set flow
 - Thermal and pressure sensors maintain flow calibration by compensating for differences between the temperature and atmospheric pressure at calibration and during sampling
- ▶ Convenient Low Flow Adapter Kit available for 5 to 500 ml/min
- ▶ Continuous sample volume calculations
 - Flow rate, run time, volume, and flow fault are continuously recorded for accurate sample reporting
- ▶ Battery status display
- ▶ Multi-tube sampling feature
 - Save valuable time with simultaneous 2, 3, or 4-tube sampling (see page 51)
- ▶ Protective features
 - Rugged, impact-resistant case with cover-protected ports
 - Automatic flow fault shutdown and restart
 - Auto shut-off at low battery



Schedule it on a PC!

Combine AirChek® 3000, your PC, and DataTrac Software to easily create single or multiple sampling schedules that include delayed start, timed shutdown, and sequential sampling. Alternatively, a single schedule can be set manually using the pump's large integral keypad.

Sample and record it!

Start sampling with the click of a mouse or the press of a button. A patented* internal flow sensor acts as a secondary standard to accurately maintain set flow. AirChek 3000 records flow rate, run time, sample volume, and flow fault throughout the sampling period. View values during sampling on the pump LCD or in pump history on a PC.

* U.S. Patent No. 5,892,160

Download and report it!

Use your PC and DataTrac Software to download pump history, import data into your favorite software for IH lab reporting, or create a worker exposure profile for complete reporting. See page 11 for details.

Schedule, Sample, Download, and Report from Your PC

Air Sample Pump



Certifications



IECEX ANZEX

Description	Voltage	SKC Ltd. Cat. No.
AirChek 3000 Pump with NiMH battery pack and tool		210-3311
Single Pump Kit-Basic includes pump as described above, single charger (223-240A), 1 meter (39 inches) of Tygon tubing, and 1 Step by Step Guide, in a durable carry case (224-98)	110-240 V	210-3311K
Single Pump Kit-Dust/Particulate includes pump as described above, single charger (223-240A), calidaptor (391-01), 1 meter (39 inches) of Tygon tubing, plastic IOM MultiDust Sampler (225-70A), 4 extra MultiDust cassettes (225-71A), Plastic Cyclone (225-69), 4 extra cyclone cassettes (225-62), and 1 Step by Step Guide, in a durable carry case (224-98)	110-240 V	210-3311KP
Single Pump Kit-Gas/Vapour includes pump as described above, single charger (223-240A), 1 meter (39 inches) of Tygon tubing, All-in-One low flow holder (224-27), tube breaker (800-01200), Type A protective tube cover (224-29A), and 1 Step by Step Guide, in a durable carry case (224-98)	110-240 V	210-3311KV
Single Pump Kit-Combined includes pump as described above and all media and accessories as described in the Single Gas/Vapour and the Single Dust/Particulate Kits, in a durable carry case (224-98)	110-240 V	210-3311KC
5-pack Pump Kit-Basic includes 5 pumps as described above, 5-station charger (223-109A), 5 one-meter (39-inch) lengths of Tygon tubing, and 3 Step by Step Guides, in a durable carry case (224-97A)	110-240 V	210-3311K5
5-pack Pump Kit-Dust/Particulate includes 5 each pumps as described above, plastic IOM MultiDust Samplers (225-70A), and Plastic Cyclones (225-69), 5 one-meter (39-inch) lengths of Tygon tubing, 10 extra cyclone cassettes (225-62), 10 extra MultiDust cassettes (225-71A), calidaptor (391-01), 5-station charger (223-109A), and 3 Step by Step Guides, in a durable carry case (224-97A)	110-240 V	210-3311K5P
5-pack Pump Kit-Gas/Vapour includes 5 each pumps as described above, All-in-One low flow holders (224-27) and Type A protective tube covers (224-29A), 5 one-meter (39-inch) lengths of Tygon tubing, a 5-station charger (223-109A), tube breaker (800-01200), and 3 Step by Step Guides, in a durable carry case (224-97A)	110-240 V	210-3311K5V
5-pack Pump Kit-Combined includes 5 pumps as described above and all media and accessories as described in the 5-pack Gas/Vapour and the 5-pack Dust/Particulate kits, in one durable carry case (224-97A)	110-240 V	210-3311K5C
Accessories		
CalChek Communication Cable , for use with Defender calibrator		210-502
DataTrac Software for AirChek 3000		877-91

AirChek 3000 requires 1/4-inch ID tubing; see page 35.

Leland Legacy

5 to 15 L/min

Applications and Typical Run Times[§]

- **24+ hours**
 - Sioutas Impactor at 9 L/min
 - IMPACT Sampler at 10 L/min
 - Low-volume PUF Tube at 5 L/min
 - DPS System (pages 24-25) at 10 L/min
 - 8 L/min Respirable PPI (pages 112-113) at 8 L/min
- **32 hours**
 - 37-mm, 0.8- μ m MCE Filter Cassette at 5 L/min (approx. 14 inches water back pressure)
- **20 hours**
 - 37-mm, 0.8- μ m MCE Filter Cassette at 8 L/min (approx. 22 inches water back pressure)
- **Other sampling applications**
 - Bioaerosols (spore traps/cassettes)
 - Nanoparticles with 37-mm MCE filter at 7 L/min

[§] Results obtained using a new pump and new fully charged battery. Pump and battery performance may vary.

Partner with the 8 L/min PPI for respirable dust sampling
see pages 112-113



Leland Legacy — the power of the DPS and DCS Systems
see pages 24-25

Leland Legacy Area or Personal High Flow Sampling

High Flows — 5 to 15 L/min

Leland Legacy[®] provides the high flows and long run times of a vacuum-style pump in a compact, portable, and battery-operated sampler within specified back pressure range.*

24-Hour Run Times on One Battery Charge

The rechargeable lithium-ion (Li-Ion) battery pack provides 24-hour run times with impactors and other sampling devices with low back pressures.* Leland Legacy is ideal for unattended ambient air sampling. See *Deployable Sampler Systems* on pages 24-25.

The Ultimate in High Flow Sampling! Advanced Flow Control

A patented[#] internal flow sensor measures flow directly and acts as a secondary standard to constantly maintain the set flow. Set flow is achieved immediately at start-up and flow calibration is automatically maintained by built-in sensors that compensate for differences in temperature and atmospheric pressure during sampling.

Flexible Programming

- **Manual three-button operation**
No tools needed! Use the built-in keypad to set, calibrate, and sample! Real-time sampling parameters are available at the touch of a button.
- **PC programmability**
Use Leland Legacy with your PC and DataTrac Software to create complete running sequences, download sampling history, and generate sampling reports for ISO 9000, Total Quality Management (TQM) programs, and occupational health and safety management systems. *DataTrac is sold separately or in 5-pack Leland Legacy Kits; see page 23.*

* Leland Legacy is not recommended for high back pressure applications such as asbestos clearance sampling.
U.S. Patent No. 5,892,160



Leland Legacy

24-hour PM Sampling with Impactors at Flows up to 10 L/min



Easy-access computer interface and battery charging jack (under protective cover)

Inlet port with removable protective filter

Bright flashing LED run indicator

Large Liquid Crystal Display (LCD)

Convenient battery status icon

Large, easy-to-use 3-button keypad

Tough rubber overmolding protects pump and provides a sure grip

Anti-static thermoplastic case



DataTrac®

Software for Leland Legacy®

Windows-based DataTrac Software for Leland Legacy sample pumps provides for maximum use of pump features and sample history download to PC for reporting.

- Program/operate your pump
- Download sampling history from pump to PC
- Set up easy chain of custody sample sheets
- Manage data and produce reports

DataTrac Software for Leland Legacy includes software on CD and DataTrac adapter cable, requires Windows XP or higher and available USB port
Cat. No. 877-92

Description	Cat. No.
Leland Legacy Pump † with Li-Ion battery pack and screwdriver set, requires charger; see kits or chargers below	100-3002
Single Pump Kit † includes pump as described above and single charger, in a Pelican carry case	100-240 V 100-3002K
5-pack Pump Kit † includes 5 Leland Legacy pumps, Take Charge 5 Multi-charger, and DataTrac Software, in a Pelican case	100-240 V 100-3002K5
Accessories	
Single Charger , for Li-Ion battery-powered pumps	100-240 V 223-241
Take Charge 5 Multi-charger , 5 stations, for Li-Ion battery-powered pumps	100-240 V 223-441
Battery Charging Adapter , for charging batteries outside the pump	223-248
CalChek Communication Cable , for use with Defender calibrator	210-502
Kit Cases	
Single, Pelican	224-912
5-pack, Pelican, on wheels for easy transport	224-905
Pump Pouch	
Noise-reducing, black nylon, reduces pump noise from 62.5 to 52 dB ^A	224-89
DataTrac Software for Leland Legacy	877-92
Replacement Battery Pack † Li-Ion	P75692

† Leland Legacy pumps contain Li-Ion batteries and may be subject to special shipping regulations.
 Δ Measured 1 meter (39 inches) from pump operating at 10 L/min without media



Noise-reducing nylon pouch
 Cat. No. 224-89

Leland Legacy requires 3/8-inch ID tubing; see page 35.

Deployable Sampler Systems

10 L/min

Deployable Systems Performance Profile

Flow Rate

10 L/min

Run Time

> 24 hrs (one battery charge)

Power

Rechargeable Li-Ion battery,

Case Dimensions

47 x 36 x 18 cm (18.5 x 14.1 x 6.9 in)

System Weight

DPS: 5.9 kg (13 lbs)

DCS: 5.5 kg (12.2 lbs)

Certification



For DataTrac Software see page 25

ABOUT SKC DCS/DPS Applications

- ARCADIS (New Jersey) used the SKC DCS for 8-hour remediation sampling of pesticides and PCBs (EPA Method TO-4A), PAHs (EPA TO-13A), and PM10. Comments on DCS performance included “reliable, well-designed for field use, and well-suited for perimeter air samples at hazardous waste sites.” DCS sample media was found to be consistent with EPA TO methods and an improvement on traditional PUF cartridges.
- University of Wisconsin-Eau Claire completed a study using the SKC DPS to study PM2.5 levels in six 24-hour samples around frac sand mines and processing sites. See “PM2.5 Airborne Particulates Near Frac Sand Operations” abstract at www.neha.org/node/4407.

Deployable Sampler Systems Ambient Air Kits for 24-hour Sampling

- ▶ **Compact, portable size — only one case!**
- ▶ **System pump provides constant, accurate airflows**
 - Simple 3-button keypad for setting a single unattended sample run
 - Program for multiple runs with a PC and DataTrac for Leland Legacy Software
- ▶ **Fast setup with modular components and quick-connect tubing**
- ▶ **Ideal for remote locations or indoor air sampling**
 - Pre-program automatic start and stop
 - 24-hour Li-Ion battery operation
 - Secure operation from within a heavy-duty lockable case
 - Quick-mount bracket is easy to install
 - Quick-change battery packs
 - Rain cover protects sampling head
 - Compact for easy transport
 - Low noise for indoors
- ▶ **Available for sampling PM10, PM2.5, or PAHs/PCBs/pesticides/associated particulate**



SKC Deployable Sampler Systems provide cost-effective ambient air sampling and are ideal for applications including fence-line, near-roadway, and eight-hour remediation monitoring and indoor air studies. Each system includes the fully programmable Leland Legacy Sample Pump, specially designed sampling head, and accessories for fast deployment and effective sampling. SKC offers two systems:

- **Deployable Particulate Sampler (DPS) System** for PM10 or PM2.5
- **Deployable Cartridge Sampler (DCS) System** for polycyclic aromatic hydrocarbons (PAHs), polychlorinated biphenyls (PCBs), pesticides, and associated particulate

Unlike other ambient sampling systems, SKC Deployable Sampler Systems fit into one heavy-duty Pelican case that is easily carried or shipped. Partner the DPS or DCS System with DataTrac Software for advanced scheduling options and record keeping.



See Ordering Information on page 25.

Deployable Particulate Sampler (DPS) System

Ambient and Indoor PM10 or PM2.5 Sampling

Description	Cat. No.	Qty.
DPS System** includes sample pump with connection case, charger (100-240 V), 2 external battery assemblies with adapters (packaged separately), IMPACT sampling head, 2 filter cassettes, calibration adapter, rain cover for sampling head, 25 disposable impaction discs (<i>limited shelf-life</i>), filter cassette opener, tubing with quick-connect fitting, and mounting bracket, in a heavy-duty lockable carry case	PM10 Kit 100-3901 PM2.5 Kit 100-3903	ea ea
Collection Filters for DPS System (not supplied with system) <i>Select a filter based on your application; required for sampling</i>		
Quartz Filters , 47 mm, Tissuquartz, 432 µm thick	225-1823	25
PTFE Filters , [§] 47 mm, 2.0-µm pore size, with PMP support ring	225-1747	50
Sampling Heads/Replacement Parts		
IMPACT Sampling Head includes filter cassette, calibration adapter, and rain cover for sampler; <i>requires collection media (see above) and impaction substrate (see below) sold separately</i>	PM2.5 225-392 PM10 225-390	ea ea
Impaction Discs , 37 mm, pre-oiled, ready to use, disposable, <i>required for sampling, limited shelf-life</i>	225-395 225-395A	25 50
Filter Cassette	225-396	ea
Accessories		
Petri Dish Slide , for filter transport	225-2-01	100
DataTrac for Leland Legacy Software includes software on CD and DataTrac adapter cable, <i>visit www.skcinc.com for details</i>	877-92	ea

* Provides data similar to data from Federal Reference Method samplers. The DPS System is not a U.S. EPA reference or equivalent method for compliance sampling.

System contains Li-Ion batteries and may be subject to special shipping regulations.

§ Back pressure on PTFE filters may vary within the same lot.



Patented[‡] IMPACT sampling head for DPS. For more information on IMPACT, see page 116.



Sampling head holds media cartridge for DCS.

‡ U.S. Patent No. 7,334,453

Deployable Cartridge Sampler (DCS) System

Ambient Sampling of PAHs, PCBs, Pesticides, and Associated Particulates

Description	Cat. No.	Qty.
DCS System** includes sample pump with connection case, charger (100-240 V), 2 external battery assemblies with adapters (packaged separately), sampling head, calibration adapter, rain cover for sampling head, sample tubing with quick-connect fitting, calibration tubing, and mounting bracket, in a heavy-duty lockable carry case	100-3960	ea
Media Cartridges , <i>required, select based on application</i> Stainless steel cartridges containing media as described below, stainless steel support screens, and gaskets. Each cartridge is wrapped in aluminum foil and shipped in an aluminum can with lid.		
Filter/PUF contains 41.3-mm length of PUF and a 47-mm quartz filter	226-206	ea
Filter/PUF/XAD-2/PUF contains a 47-mm quartz filter and 2 grams of XAD-2 sorbent sandwiched between two 20.6-mm lengths of PUF	226-207	ea
Accessories		
DataTrac for Leland Legacy Software includes software on CD and DataTrac adapter cable, <i>visit www.skcinc.com for details</i>	877-92	ea

* Provides data similar to data from Federal Reference Method samplers. The DCS System is not a U.S. EPA reference or equivalent method for compliance sampling.

System contains Li-Ion batteries and may be subject to special shipping regulations.



Leland Legacy Sample Pump
The Power of the DPS and DCS Systems
See pages 22-23 for more information.

QuickTake 30

10 to 30 L/min

QuickTake 30

Powered by Supercharged Lithium-Ion Battery

10 to 30 L/min constant flow...

for sampling with BioStage viable cascade impactors, spore trap cassettes, microvacuum cassettes, or other samplers that require flows up to 30 L/min

It's compact and portable!

QuickTake® 30 weighs only 2.2 kg (4.8 pounds) and features an easy-grip handle for portability.

Reliable long run times...

on a single battery charge with powerful Li-Ion battery (see page 27)

Easy operation...

with large keypad buttons, high-contrast digital display, front-mounted intake for fast media setup, and programmable timer

Versatility...

with the mounting bracket accessory to mount a BioStage impactor directly onto the pump



Programmable
True constant flow
Easy calibration

14+ hours run time
at 10 L/min



QuickTake 30 Sample Pump Solution for Mold

- ▶ **10 to 30 L/min constant flow sample pump**
 - Maintains set flow throughout a sampling period for complete sample integrity
 - Ideal for use with BioStage viable cascade impactors, spore trap cassettes such as VersaTrap, microvacuum cassettes, or other samplers that require flows up to 30 L/min
- ▶ **Long run times on a single battery charge**
 - AC charger/adaptor for extended sampling
 - Rechargeable Li-Ion battery pack
- ▶ **Compact and portable**
 - 23.6 x 21.3 x 8.9 cm (9.3 x 8.4 x 3.5 inches)
 - Weighs only 2.2 kg (4.8 pounds)
 - Handle for easy portability
- ▶ **Easy-to-use programmable timer for unattended sampling**
 - Select sample time presets or customize timer from 1 to 999 minutes
 - Continuous run with manual shut-off
 - Intermittent sampling
 - Large, easy-to-use keypad
- ▶ **Easy to use**
 - Large keypad control
 - End-of-cycle visible and audible alarms
- ▶ **High-contrast digital display**

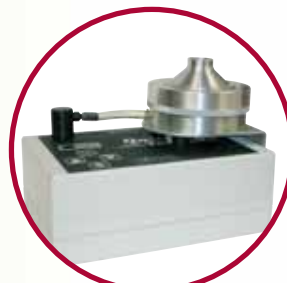

QuickTake 30 with BioStage on mounting bracket



QuickTake 30 with VersaTrap cassette mounted on pump inlet

the QuickTake 30 **Advantage!**

- ✓ Maintains true constant flow even when used with media that creates back pressure such as wall cavity samplers (see page 101) and microvacuum cassettes (see page 142)
- ✓ A low-noise, battery-powered alternative to vacuum pumps

QuickTake 30 Applications and Typical Run Times[§]

- **14+ hours**
– 37-mm, 0.8- μ m MCE filter at 10 L/min
- **9+ hours — asbestos clearance**
For maximum air volumes during asbestos clearance sampling, use QuickTake 30 with a 25-mm, 1.2- μ m MCE filter at 10 L/min with fully charged battery and AC power to achieve 9+ hours of run time — a total air volume of 5400 liters
- **5 hours**
– Spore trap cassettes at 15 L/min
- **4 hours**
– Viable cascade impactors at 28.3 L/min

[§] Results obtained using a new pump and new, fully charged battery. Pump and battery performance may vary.

Description		Cat. No.
QuickTake 30 Sample Pump** and Charger	100-240 V	228-9530
QuickTake 30 Sample Pump,** Rotameter, and Charger	100-240 V	228-9530A
QuickTake 30 BioStage Pump** Kit includes pump, charger, rotameter, Standard BioStage, mounting bracket with inlet adapter, and calibration adapter, in a deluxe carry case	100-240 V	228-9530K
Accessories		
Charger/Adapter	100-240 V	223-245
Mounting Bracket for BioStage includes inlet adapter		228-9531
Rotameter, 3 to 30 L/min		320-100
Replacement Battery Pack,* Li-Ion		P75689
Replacement Filter/O-ring Set includes 5 filters and 1 O-ring		P40021

* QuickTake sample pumps contain Li-Ion batteries and may be subject to special shipping regulations.

Not CE marked

QuickTake 30 requires 3/8-inch ID tubing; see page 35.

BioStage Impactors
see page 120

Flite 3 Asbestos/High Flow Pump

2 to 20 L/min

Flite 3 Performance Profile

Flow Range
2 to 20 L/min

Operating Temperature
-5 to 50 C (23 to 122 F)

Battery
Lead-acid, available with
3.2 or 7-Ah capacity

Dimensions
11 x 20 x 18 cm (4.3 x 7.9 x 7 in)

Weight (pump only)
2.24 kg (4.9 lbs)

Certification



Typical Run Time*

Filter	Flow (L/min)	Run Time (Hrs)
25-mm MCE, 0.8 µm	4	30
25-mm MCE, 0.8 µm	8	13
25-mm MCE, 0.8 µm	12	4.5
25-mm MCE, 1.2 µm	4	32
25-mm MCE, 1.2 µm	8	15
25-mm MCE, 1.2 µm	12	8
25-mm Glass Fiber	8	16
25-mm Glass Fiber	12	8.5
25-mm Glass Fiber	16	5.5

* Using new, fully charged 7-Ah battery in clean factory conditions. Pump and battery performance may vary.



Flite 3 Sample Pump with Aluminum Sampling Mast
Cat. No. 901-213

Flite 3

Programmable High Flow Pump for Asbestos and More

- **Wide flow range: 2 to 20 L/min**
- **Fully programmable**
 - Manual run
 - Timed run and delayed start
 - Intermittent sampling
- **Robust steel casing**
- **Sturdy handle for easy portability**
- **Long run times**
- **High-performance sampling capabilities**
- **Convenient front-mounted power socket**
- **Battery or AC operation**
 - Choose lightweight 3.2-Ah battery or long-run 7-Ah battery
- **Flow fault feature ensures sample integrity**
 - Run time display is retained during fault



The highly versatile SKC Flite 3 air sample pump provides high-performance sampling for asbestos and other particulates. With features such as a robust steel casing to withstand daily rigors, a front-mounted power socket to provide easy access for charging or powering, and a sturdy handle for easy portability, the Flite 3 is the choice for most high-volume sampling applications. Use the fully programmable timer to set a manual run, a timed run with or without delayed start, or intermittent sampling. Flite 3 is ideal for area and environmental monitoring, stack sampling, indoor air studies, asbestos monitoring, biosampling, and long-term background monitoring.

Description	Cat. No.
Flite 3 Sample Pump Only	901-3011
Flite 3 Pump Kits	
Sample Pump with 3.2-Ah lightweight battery, charger (100-240 V), and 1 meter (39 inches) of Tygon tubing	901-3011-3K
Sample Pump with 7-Ah long run time battery, charger (100-240 V), and 1 meter (39 inches) of Tygon tubing	901-3011-7K
Sampling Accessories	Cat. No.
Rigid Aluminum Sampling Mast	901-213
Asbestos Sampling Head, 25 mm, with aluminum cowl	225-54A
Power Accessories	Cat. No.
Battery Charger, 110-240 V, multi-plug	901-310
AC Adapter, 110-240 V, multi-plug	901-311
Replacement Lead-acid Battery	
3.2-Ah Capacity	P901301
7-Ah Capacity	P901302

Flite 3 requires 1/4-inch ID tubing; see page 35.

AirLite – Economy on the Go

5 to 3000 ml/min with AA Alkaline Batteries

► **Simple operation**

- Turn on, calibrate, and sample — no programming or battery charging

► **Simple power**

- Economical, disposable AA alkaline batteries are ready to go anytime for over 10 hours (*see run times at far right*)

► **Compact design**

- AirLite fits in the palm of your hand!
- 340 grams (12 ounces)

► **Sample integrity**

- Constant flows up to 3000 ml/min[†]
- Patented** flow control system holds constant flow to ± 5% of set-point
- Compensation for back pressure and temperature changes
- Low battery and flow fault indicator and shut-off

► **The simple choice for:**

- Abatement projects
- Indoor air sampling
- Emergency response

No charger required!



AirLite Typical Run Times[†]

Mixed Cellulose (MCE) Filter
0.8-µm pore size

Filter Diameter	37 mm	37 mm	25 mm
Flow Rate	1 L/min	2 L/min	2 L/min
Duracell Standard	23.5	14.5	10.5
Rayovac Maximum	20.0	16.5	11.0
Walmart EverActive	24.0	16.0	10.5

Glass Fiber Filter

Filter Diameter	37 mm	37 mm	25 mm
Flow Rate	1 L/min	2 L/min	2 L/min
Energizer	29.5	18.0	18.5
Rayovac Maximum	26.5	23.5	19.5
Walmart EverActive	33.5	24.5	20.0

[†] Run times in hours. Obtained using new pump and new alkaline batteries. Pump and battery performance may vary.

Certification



AirLite® is the simple solution when a 5 to 3000 ml/min sampler is needed for abatement projects, indoor air sampling, and emergency response in environments that do not require intrinsic safety. AirLite maintains full back pressure compensation from 1000 to 3000 ml/min; flows from 5 to 500 ml/min require low flow accessory (*see below*). Powered by economical, disposable AA alkaline batteries, AirLite provides run times greater than 10 hours (*see run times at above right*). AirLite is ready to go anytime you are!



Small and lightweight battery-powered AirLite

Description	AirLite SKC Inc. Cat. No.	AirLite SKC Ltd. Cat. No.
AirLite Pump* with 3 AA alkaline batteries and screwdriver set	110-100	110-100
Single Pump Kit-Dust/Particulate includes pump* as described above, calidaptor (391-01), 1 meter (39 inches) of Tygon tubing, plastic IOM MultiDust Sampler (225-70A), 4 extra MultiDust cassettes (225-71A), Plastic Cyclone (225-69), 4 extra cyclone cassettes (225-62), and 1 Step by Step Guide, in a durable carry case (224-98)		110-100KP
5-pack Pump Kit-High Flow includes 5 pumps* as described above and filter cassette holders (225-1), in a Pelican carry case (224-907)	110-100K5	
5-pack Pump Kit-Dust/Particulate includes 5 pumps as described above, plastic IOM MultiDust Samplers (225-70A), and Plastic Cyclones (225-69), 5 one-meter (39-inch) lengths of Tygon tubing, 10 extra cyclone cassettes (225-62), 10 extra MultiDust cassettes (225-71A), calidaptor (391-01), and 3 Step by Step Guides, in a durable carry case (224-97B)		110-100K5P

* Not intrinsically safe

‡ Flows from 5 to 500 ml/min require Low Flow Adapter Kit accessory. See pages 50-51.

** U.S. Patent No. 6,741,056

The AirLite Pump requires 1/4-inch ID tubing; see page 35.

Tech Tips

- The AirLite Sample Pump may be used with rechargeable 1.5-volt AA batteries instead of disposable batteries but will only achieve half the run time.

Personal Sample Pump Battery Chargers

SKC PowerFlex Chargers

SKC PowerFlex® battery charging systems provide flexibility for your fleet of NiMH and NiCad powered SKC personal sample pumps. Pump-specific cables allow connection and charging of batteries in different SKC personal pump models while using one PowerFlex charger! Instead of carrying several bulky wall cubes or charging units, you only need one lightweight charger and the appropriate cables. The 5-station PowerFlex can charge up to three different SKC pump models simultaneously. See PowerFlex charger ordering (Cat. Nos. 223-1000 and -2000 and 223-1000 Series cables) in table at right.

ABOUT

Battery Maintenance









Battery life is based on chemistry, environmental conditions, and patterns of use. Go to www.skcin.com/instructions/1756.pdf to learn about recommended use, maintenance, and storage that will maximize each battery chemistry's advantages, minimize disadvantages, and provide for optimal battery performance and cycle life.

5-station PowerFlex Carry Case

Includes padded shoulder strap and compartment for cables. Also included with single pump kits. See page 35.



Cat. No.224-903

SKC Pump	Universal UL	Universal ATEX	AirChek TOUCH	AirChek 3000
Single Chargers (100-240 V)				
Cat. No.	PowerFlex*** 223-2000	223-203A	Choose a charging cradle:*	
5-station Chargers (100-240 V)			Standard Cradle 220-800	
Cat. No.	PowerFlex*** 223-1000	223-103A	e-Cradle 220-900	223-240A
Required PowerFlex Cable(s)			Choose a power supply:*	
Cat. No.	223-1002	N/A	Single – For use with 1 cradle 220-600	
Replacement Batteries†			Multi – For use with 2 to 5 cradles 220-700	223-109A
Cat. No.	P21661MH (NiMH) P21661 (NiCad)	P22419MTX		N/A
Battery Eliminators for Line Operation				
Cat. No.	223-325 (115 V) 223-325B (230 V)	223-305C - U.K. Plug 223-305B - Euro Plug	See cradles and power supplies (above)	223-330C - U.K. Plug 223-330B - Euro Plug

For use with U.S.-produced pump models only; not compatible with EX or ATEX models

* Cradle and power supply required; each sold separately

** CE marked when used with the power supply provided by SKC; power supply is UL and cUL Listed for electrical safety

† Replacing batteries with non-approved battery packs voids any warranty and intrinsic safety approvals.

‡ Li-Ion batteries may be subject to special shipping regulations.

Ordering a PowerFlex Charger?

Don't forget to order PowerFlex Cables!

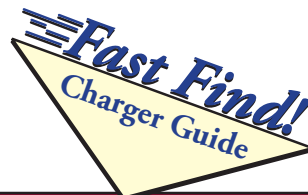

AirChek 52	Sidekick	Pocket Pump TOUCH	AirChek XR5000	Leland Legacy
PowerFlex*** 223-2000	223-203A	Single Charger 220-300	223-241	223-241
PowerFlex*** 223-1000	223-103A	5-port USB Charging Hub 220-400	Take Charge 5 223-441 ^Δ	Take Charge 5 223-441 ^Δ
223-1004	N/A	N/A	N/A	N/A
P78011AMH (NiMH) P78011A (NiCad)	P78050MH - Standard Sidekick P78051MTX - Deluxe and Intermediate Sidekick	P76303	P85004 (4-cell Li-Ion) [‡] P85002 (2-cell Li-Ion) [‡]	P75692 (Li-Ion) [‡]
223-300 (115 V)	223-300C - U.K. Plug 223-300B - Euro Plug	220-300	223-241	223-241

‡ Li-Ion batteries may be subject to special shipping regulations.

Δ Not CE approved

ABOUT

Charging NiMH Batteries

Use SKC-approved PowerFlex chargers (see page 30) for charging nickel-metal hydride (NiMH) pump batteries. For more information, go to www.skcinc.com/instructions/1756.pdf.

Charging Li-Ion Batteries

SKC Li-Ion pump batteries must be charged using SKC-approved single and 5-station Li-Ion battery chargers (see left for ordering). These chargers provide the smart circuitry required to keep Li-Ion batteries in optimum operating condition. For more information on the characteristics of Li-Ion batteries, go to www.skcinc.com/instructions/1756.pdf.

Tech Tips

► Li-Ion is a "clean" system and only takes what it can absorb; therefore, Li-Ion batteries do not require the continuous "trickle" charge that other battery chemistries need. SKC Li-Ion battery chargers apply a trickle charge to fully charged Li-Ion batteries **only when the charger senses a drop in battery voltage** (such as occurs with self-discharge while the battery is stored on the charger). Once full battery voltage is restored, the charger shuts off the trickle charge.



More Information

SKC Sample Pump Battery Pack Characteristics and Maintenance at www.skcinc.com/instructions/1756.pdf

www.skcinc.com

SKC

New!

chek-mate

Calibrator

- **0.75 to 5 L/min flow range**
 - Contact SKC for calibrators to measure other flow ranges
- **Volumetric accuracy of 1%**
- **Less than 10-minute stabilization to ambient temperature**
- **Built-in sensors adjust for changes in temperature and atmospheric pressure**
- **Calibration laboratory accuracy certified by UKAS/NIST and backed by ISO 17025 accreditation**
 - Calibration certificate supplied
- **Displays continuous real-time volumetric flow rate readings in L/min**
- **Sleek design is field portable for calibration anywhere, anytime**
 - 18 x 8.3 x 3.3 cm (7.1 x 3.3 x 1.3 inches)
 - Only 242 grams (8.5 ounces)
 - Compact for handheld use
- **9-volt alkaline battery operation**
 - Auto shut-off feature conserves battery
- **Use in any orientation**
 - No moving parts

18 cm



3.3 cm

8.3 cm

Certifications



Standard of Good Practice

Before sampling, set and verify pump flow rate to that required in the sampling method. After sampling, verify that the flow rate has not changed by more than $\pm 5\%$ during the sampling period.



Differential pressure flowmeter provides fast, accurate readings anywhere, anytime.

Description		Cat. No.
chek-mate Flowmeter includes 9-volt alkaline battery	with NIST-traceable calibration certificate with UKAS-traceable calibration certificate	375-07550N 375-07550

Economical Field Rotameters Secondary Flow Standards

Tech Tips

- ▶ A primary standard, as it relates to flowmeters, is based on direct and measurable linear dimensions, such as the length and diameter of a cylinder, which will not change over time.
- ▶ Rotameters and other flowmeters, such as wet test meters and dry gas meters, are termed secondary standards. Secondary standards can be used to obtain accurate, reliable measurements of pump flow rates if they are calibrated to a primary standard.

- ▶ Easy-to-read scales
- ▶ Provisions for panel mounting
- ▶ Lightweight, rugged, and portable



Meas. Range (L/min)	Scale (inch)	Accuracy*	Cat. No.
0.05 to 0.5	2	5%	320-2A05
0.1 to 1.0†	4	3%	320-4A1
0.4 to 5.0	4	3%	320-4A5
2 to 20	4	3%	320-4A20L
4 to 50	4	3%	320-440
3 to 30	4	3%	320-530
3 to 30	4	3%	320-100‡

* Full scale † Fittings adapted for QuickTake 30 sample pump
‡ Product scale is marked in CCM (cc/min), which is equivalent to ml/min.

Rotameters with 100-mm Scale

2.5% VDI/VDE 3513-2:2008

Meas. Range (L/min)	Cat. No.
0.02 to 0.25*	393-002025
0.3 to 3.4	393-0334
0.6 to 5	393-0650
1 to 13	393-1130
2 to 26	393-2260
Accessories	
Calidaptor, for hands-free IOM calibration	391-01
Cowled Head Adapter	391-05

* 2.5% Full-scale accuracy

Pneumatic Test Kit

The Pneumatic Test Kit is an all-in-one kit for testing sample pump flow range compensation. The kit includes a rotameter that measures 1 to 5 L/min, a valve, and a magnetic gauge that reads from 0 to 80 inches water back pressure.



Cat. No.224-6580



For Tubing
see page 35

Soap Film Flowmeters Primary Standards for Calibrating Sample Pumps

Description	Meas. Range (ml/min)	Cat. No.
Laboratory Film Flowmeter Kit ^Δ includes precision glass buret, film solution, operating instructions, adapter for vacuum or pressure, and aluminum tripod stand	300 to 3000	311-1000
Portable Field Flowmeter Kit ^Δ includes precision glass buret, film solution, operating instructions, and carry case	5 to 500	303
Calibrating Accessories		
Film Solution, 473 ml (1 pint)		302-4011
Precision Digital Stopwatch, powered by lithium battery		303-01-1

^Δ Laboratory Film and Portable Field Flowmeter Kits are calibrated to a primary standard ± 2% of the volumes marked on the flowmeter.

Pump Sampling Accessories

Personal Exposure Vest

- Channels prevent tubing snags/kinks
- Snap-on pockets for up to 6 pumps
- Comfortable, evenly weighted
- Safety yellow, ANSI Class 2 compliant
- Self-extinguishing/fire-resistant polyester mesh



See page 105 for details and ordering.

Tripod Stand

Stand telescopes to 1.5 meters (5 feet) and holds sampling media securely for breathing zone measurements. Stand does not hold a pump.



Description	Cat. No.
Tripod, for cassette or BioStage Impactor	228-506



Tubing for Air Sampling

Description	Applications	Diameter Inches (mm)		Cat. No.	Length in Meters (feet)
		ID	OD		
Tygon	Sampling trains	4.76 (3/16)	7.94 (5/16)	225-1346	3 (10)
Tygon	Sampling trains; fits over impinger sidearm, impinger inlet, filter cassette outlet, or Luer adapter	6.35 (1/4)	9.53 (3/8)	225-13-4A	1 (3.3)
				225-13-4	3 (10)
				225-1345	15 (50)
Tygon	For calibrating QuickTake pumps	9.53 (3/8)	12.7 (1/2)	225-1351	3 (10)
				225-1352	15 (50)
Tygon	For calibrating DPS	7.94 (5/16)	14.29 (9/16)	225-1349	3 (10)
Latex Rubber, black	Sampling trains	4.76 (3/16)	7.94 (5/16)	226-03-003	3.7 (12)
Latex Rubber, black	Sampling trains; fits over impinger sidearm, impinger inlet, filter cassette outlet, or Luer adapter	6.35 (1/4)	9.53 (3/8)	226-03-004	3.7 (12)
Latex Rubber, amber	Sampling trains; fits over impinger sidearm, impinger inlet, filter cassette outlet, or Luer adapter	6.35 (1/4)	9.53 (3/8)	225-1347	3 (10)
Polyurethane, reinforced to prevent kinking	Sampling trains; fits over impinger sidearm, impinger inlet, filter cassette outlet, or Luer adapter	6.35 (1/4)	11.9 (15/32)	225-1350	3 (10)
PTFE†	Inert for bag sampling; fits over bag fitting	4.76 (3/16)	6.35 (1/4)	231-9-23	3 (10)
PTFE†	Inert for bag sampling; fits inside bag fitting	1.59 (1/16)	3.18 (1/8)	231-9-21	3 (10)
PTFE†	Inert for bag sampling; fits Vac-U-Chamber sample inlet	6.35 (1/4)	7.94 (5/16)	231-937	3 (10)
				231-924	15 (50)

† PTFE tubing is not suitable for particulate sampling because static effect can cause sample loss in the tubing.

Tubing Accessories	Cat. No.	Qty.
PVC Adapters, Luer taper connects to 6.35-mm (1/4-inch) ID tubing	225-13-2	10
	225-132A	250
Spring Tubing Support, for use with 7.94-mm (5/16-inch) OD tubing to prevent kinking	225-1348	5
Tubing, Collar Clip, and Cable Ties	225-13-8	ea
Collar Clip and Cable Ties only	225-13-6	10



Pump Cases and Protective Pouches

Description	Cat. No.
5-pack Pump Kit Carry Cases , watertight, airtight, dustproof, and crushproof, equipped with foam for complete equipment protection (Pelican)	
AirChek TOUCH, on wheels for easy transport	224-914
AirChek 3000, AirChek 52/Sidekick, AirLite, or XR5000, on wheels for easy transport	224-907
Universal XR Series	224-908
Pocket Pump TOUCH	224-915
AirChek 3000, AirChek 52/Sidekick, or XR5000 Deluxe Kit, on wheels for easy transport	224-910
Single Pump Kit Carry Cases	
Pelican (shown at right)	224-901
Nylon with shoulder strap (shown at right), also used for 5-station PowerFlex	224-903
Protective Pump Pouches , for personal sampling, designed for personal comfort with adjustable waist belt, and shoulder strap	
Universal XR	Black 224-87 Red (shown at right) 224-95A
AirChek 3000, XR5000,† or AirChek 52/Sidekick	Black 224-88 Red (shown at right) 224-96A
AirLite	Black, with belt loop (no shoulder or waist strap) 224-902
AirChek TOUCH	Black 224-911
Noise-reducing Pump Pouches , reduce noise level from 62.5 to 55 dBA*	
AirChek 3000, XR5000,† or AirChek 52/Sidekick	Black (shown at right) 224-96C
XR5000 Standard Model (2-cell Li-Ion)	Black 224-913
Waist Belt, extends up to 122 cm (48 inches)	224-12
For Leland Legacy pump pouch and cases, see p. 23	



Soft-side nylon case Cat. No. 224-903 standard in single pump kits



Protective and noise-reducing pump pouches Cat. Nos. 224-95A, 224-96A, and 224-96C



Hard-sided Pelican case Cat. No. 224-901 alternative case for single pump kits

† High-power Li-Ion model only

* Measured at 1 meter (39 inches) from an AirChek 52/Sidekick pump running at 2 L/min with 37-mm, 0.8-µm MCE cassette

SKC Quality Sorbent Tubes

SKC on the Outside Means Quality on the Inside

SKC was the first to bring the NIOSH sorbent tube design to the commercial market over 40 years ago.

SKC leads the way in sorbent tube research to make quality sorbent tubes available for protecting workers and public health.

Over 100 SKC Sorbent Tubes are available for standard and specialty applications. SKC also manufactures custom sorbent tubes to your specifications.

Look for the SKC name when choosing sorbent tubes. SKC brings to you over 40 years of expertise, the support of experienced technical professionals, low background sorbents, quality manufacturing, QC data online, repeatable performance, and accurate sampling.



Anasorb

A Trademark of Quality

In 1973, SKC made the first commercial sorbent tube. Since then, SKC has led advancements in sorbent tube technology. To more easily identify SKC proprietary sorbents in air sampling methods, the registered trademark, Anasorb, is used for SKC proprietary sorbents of all types.

Sorbent Equivalencies

Anasorb	Equivalent Sorbent
708	Chromosorb 108
727	Chromosorb 106
C300	Hydrar, Carulite
CSC	None
747	None
GCB1	Carbotrap B (20/40) Carbopack B (60/80)
GCB2	Carbotrap C (20/40) Carbopack C (60/80)

Seeing is Believing!

Visit www.skcinc.com/catalog/infopage.php?id=5200 to view Sorbent Background Certificates of Analysis.



For Sample Pumps
see pages 4-29

- Meet NIOSH and OSHA specifications
- High-quality, low-background sorbents
- SKC quality control ensures sorbents and tubes meet high standards
 - Accurate sorbent weights
 - Consistent method-specified mesh size and separators
 - Tested for uniform back pressure
 - Accurate, repeatable results
- Large batch production of Anasorb® CSC Lot 2000 charcoal to ensure availability for many years
- Backup sorbent layer for breakthrough indication
- Validation of reliability
 - Specified in OSHA, NIOSH, and EPA methods
 - Used by health and safety professionals around the world for compliance and consulting
- Sorbent background certification available online (see right)

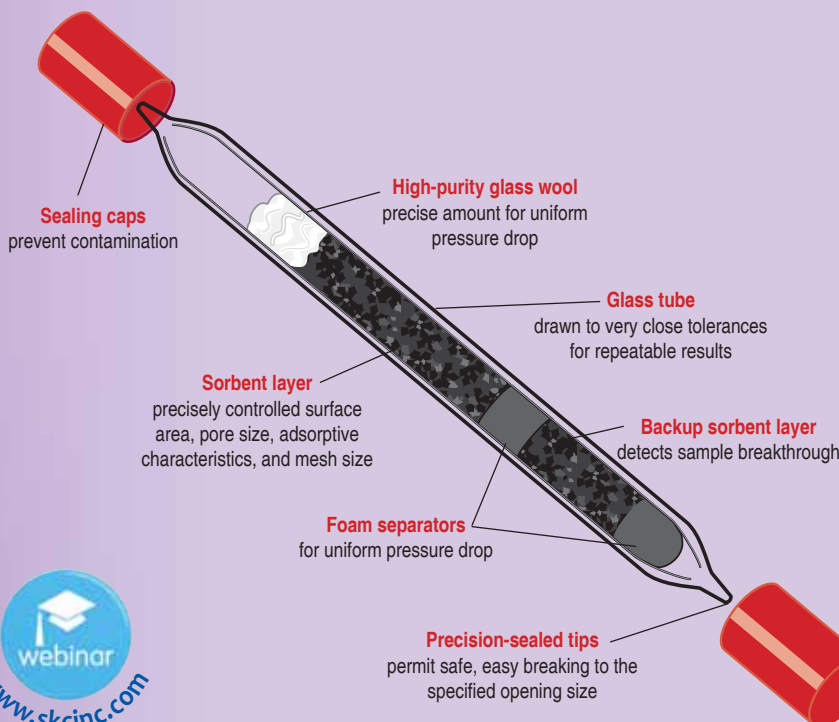

Sorbent Tube Selection Guide

To select a tube for a specific compound, refer to the SKC Sampling Guide on catalog pages 143-211 or search the online Sampling Guide at www.skinc.com for methods and required sorbent tubes.

the SKC Advantage!

- ✓ **Produced the first commercial sorbent tube**
- ✓ **Over 40 years of proven performance!**
- ✓ **Validation and reliability**
SKC tubes are specified and used by OSHA, NIOSH, EPA, and health and safety professionals around the globe for compliance and consulting.
- ✓ **High-quality, low-background sorbents**
- ✓ **Consistent method-specified mesh size and separators** maintain uniform back pressure and breakthrough volumes.
- ✓ **Large batch production**
Anasorb CSC Lot 2000 charcoal will be available for many years.
- ✓ **Sorbent background certification available online**
- ✓ **Backup sorbent layer** for breakthrough indication
- ✓ **Technical backup**
SKC technical experts provide fast, accurate answers to your questions.
- ✓ **Easy-off "hat" caps on specialty tubes**



For tube holders and accessories see pages 50-51

Cat. No.	Sorbent (treatment)	Size (mm) OD x L	Sections	Sorbent (mg)	Ends	Separators	Tube Cover	Qty.
226-01	Anasorb CSC, Coconut Charcoal	6 x 70	2	100/50	GS	F F W	A	50
226-01A	Anasorb CSC, Coconut Charcoal	6 x 70	2	100/50	GS	F F W	A	10
226-01-BULK	Anasorb CSC, Coconut Charcoal	6 x 70	2	100/50	GS	F F W	A	1000
226-01GWS	Anasorb CSC, Coconut Charcoal	6 x 70	2	100/50	GS	W W W	A	50
226-09	Anasorb CSC, Coconut Charcoal	8 x 110	2	400/200	GS	F W W	B	50
226-09-BULK	Anasorb CSC, Coconut Charcoal	8 x 110	2	400/200	GS	F W W	B	1000
226-09-02	Anasorb CSC, Coconut Charcoal	8 x 150	3	350/350/350	GS	W W W W	C	50
226-10	Silica Gel	6 x 70	2	150/75	GS	F W W	A	50
226-10-03	Silica Gel (specially cleaned)	7 x 110	2	400/200	GS	W W G W	B	50
226-10-04	Silica Gel	8 x 110	2	300/150	GS	W W W	B	50
226-10-06*	Silica Gel (sulfuric acid)	6 x 70	2	200/100	GS	W W W	A	50
226-15	Silica Gel	8 x 110	2	520/260	GS	F W W	B	50
226-15GWS	Silica Gel	8 x 110	2	520/260	GS	W W W	B	50
226-16	Anasorb CSC, Coconut Charcoal	10 x 110	2	800/200	GS	F W W	C	50
226-16-02	Anasorb CSC, Coconut Charcoal	10 x 160	2	1800/200	GS	F W W	D	50
226-17-1A	Anasorb C300†	6 x 70	1	200	GS	W W	A	50
226-17-3A	Anasorb C300†	8 x 110	1	500	GS	W W	B	50
226-18	Alumina	8 x 110	2	400/200	GS	F W W	B	50
226-22	Silica Gel	10 x 110	2	1040/260	GS	F W W	C	50
226-23*	XAD-2 (octanoic acid)	6 x 70	2	100/50	GS	W W W	A	50
226-25	Anasorb CSC, Coconut Charcoal Anasorb CSC, Coconut Charcoal	8 x 110 8 x 110	1 1	400 200	GS	W W W W	D	50 sets
226-27 [◇]	XAD-2 (2-hydroxymethyl piperidine)	8 x 110	2	450/225	GS	W W W	B	20
226-28	Soda Lime	7 x 110	2	600/200	GS	W W W G W	B	50
226-29*	Anasorb 747 (sulfuric acid)	8 x 110	2	500/250	GS	W W W	B	50
226-30	XAD-2	7 x 70	2	80/40	GS	W W W	B	50
226-3002A	XAD-2 XAD-2	10 x 110 10 x 110	1 1	600 300	GS	W W W W	D	10 sets
226-30-03	XAD-2	8 x 110	2	100/30	GS	W W W	B	50
226-30-04	XAD-2	8 x 110	2	100/50	GS	W W W	B	50
226-30-05	XAD-2	8 x 110	2	150/75	GS	W W W	B	50
226-30-06	XAD-2	8 x 110	2	400/200	GS	W W W	B	50
226-30-07 [◇]	XAD-2 (p-anisidine)	8 x 110	2	100/50	GS	W W W	B	20
226-30-08	Anasorb 708	6 x 70	1	100	GS	W W	A	50
226-30-16* (OVS)	XAD-2/Glass Fiber Filter	13→8 x 75	2	270/140	GO	F F G T	V	10
226-30-16A* (OVS)	XAD-2/Glass Fiber Filter	13→8 x 75	2	270/140	GO	F F G T	V	50
226-30-18*	XAD-2 (naphthylisothiocyanate)	6 x 70	2	80/40	GS	W W W	A	50
226-35	Tenax TA	6 x 70	2	30/15	GS	F W W	A	50
226-35-01*	Tenax TA	6 x 70	2	20/10	GO	W W W	A	50
226-35-02*	Tenax TA Tenax TA	6 x 130 6 x 130	1 1	35 17	GO	W W W W	—	50 sets

* Limited shelf-life; contact SKC for more information † Anasorb C300 is equivalent to Hydrar and Carulite.

◇ Limited shelf-life; refrigerator/freezer storage may be required. Contact SKC.

TUBE ENDS: GS: Glass Sealed GO: Glass Open SS: Stainless Steel Open

SEPARATORS: W: Glass Wool G: Glass Fiber Filter F: Foam T: PTFE Ring S: Screen N: Nylon Ring Q: Quartz Filter R: Glass Spacer

For compliance sampling, use tubes as specified in a validated sampling method. It is the user's responsibility, employing a suitable method, to establish appropriate safety and health practices and to determine the applicability of regulatory limitations before use. The user should adjust the sampling parameters for specific conditions and evaluate tubes under conditions of use to ensure that the desired results will be obtained.

Sorbent Tube Selection Guide

To select a tube for a specific compound, refer to the SKC Sampling Guide on catalog pages 143-211 or search the online Sampling Guide at www.skcinc.com for methods and required sorbent tubes.

Cat. No.	Sorbent (treatment)	Size (mm) OD x L	Sections	Sorbent (mg)	Ends	Separators	Tube Cover	Qty.
226-35-03	Tenax TA	8 x 110	2	100/50	GS	W W W	B	50
226-35031	Tenax TA	8 x 110	2	100/50	GS	W W W	B	10
226-36	JXC Charcoal	8 x 150	2	630/315	GS	F W W	C	50
226-37	Anasorb CSC, Coconut Charcoal Anasorb CSC, Coconut Charcoal	8 x 110 8 x 110	1 1	400 200	GS	F W F W	D	50 sets
226-39	Florisol	6 x 70	2	100/50	GS	W W W	A	50
226-39-02	Florisol	8 x 110	2	400/200	GS	W W W	B	50
226-40 [◇]	Oxidizer Molecular Sieve (triethanolamine) (2 tubes)	7 x 110 7 x 70 (2)	1 1	800 400 (2)	GS	W W W W	—	10 sets
226-40-02*	Molecular Sieve (triethanolamine)	7 x 110	2	400/200	GS	W W W	B	50
226-42*	Silica Gel (sulfuric acid)	8 x 110	2	200/200	GS	W W W	B	50
226-42-02*	Firebrick (gas chrom-R) (sulfuric acid)	7 x 70	1	300	GS	W W	B	50
226-44	Drying Tube	6 x 70	1	250	GS	W W	—	50
226-44-02	Drying Tube	10 x 160	1	900	GS	W W	—	50
226-47-01	Silica Gel	6 x 70	2	100/50	GS	W W W	A	50
226-48	Silica Gel	7 x 110	2	150/150	GS	W W W	B	50
226-49-102	Chromosorb 102	6 x 70	2	66/33	GS	W W W	A	50
226-49-106	Chromosorb 106	6 x 70	2	75/37	GS	W W W	A	50
226-49-108	Anasorb 708	6 x 70	2	75/37	GS	W W W	A	50
226-51	Silica Gel	6 x 70	2	100/50	GS	F W W	A	50
226-53*	Silica Gel (sulfuric acid)	6 x 70	2	150/75	GS	W W W	A	50
226-54 [◇]	XAD-2 (2-hydroxymethyl piperidine)	6 x 70	2	45/23	GS	W W W	A	20
226-55*	Silica Gel (sodium hydroxide)	7 x 70	2	150/75	GS	W W W	B	20
226-56* (OVS)	Tenax TA/Glass Fiber Filter	13→8 x 75	2	140/70	GO	F F G T	V	10
226-57* (OVS)	XAD-7/Glass Fiber Filter	13→8 x 75	2	200/100	GO	F F G T	V	10
226-57A* (OVS)	XAD-7/Glass Fiber Filter	13→8 x 75	2	200/100	GO	F F G T	V	50
226-58* (OVS)	XAD-2/Quartz Filter	13→8 x 75	2	270/140	GO	F F Q T	V	10
226-58A* (OVS)	XAD-2/Quartz Filter	13→8 x 75	2	270/140	GO	F F Q T	V	50
226-59-01	Porapak-N	6 x 70	2	88/44	GS	W W W	A	50
226-59-03	Porapak-Q	6 x 70	2	78/39	GS	W W W	A	50
226-59-04	Porapak-R	6 x 70	2	70/35	GS	W W W	A	50
226-61*	Silica Gel/Charcoal (charcoal treated with sodium hydroxide)	10 x 210 10 x 210	3 3	750/1250/250 750/1250/250	GS	W W R W W R W W	D D	50 20
226-67*	Anasorb CSC, Coconut Charcoal (potassium hydroxide)	6 x 70	2	100/50	GS	W R W W	A	50
226-68 [◇]	JXC Charcoal, Drierite (hydroquinone)	8→6 x 160	3	1600/160/110	GS	W W W W	D	20
226-70A [◇]	Silica Gel (p-methoxyphenol)	8 x 150	2	1200/600	GS	W W W	C	10
226-73*	Anasorb CSC, Coconut Charcoal (t-butylcatechol)	6 x 70	2	100/50	GS	W W W	A	50
226-75	Anasorb 727 [¥]	8 x 110	2	300/150	GS	W W W	B	20
226-80*	Anasorb 747 (potassium hydroxide)	6 x 70	2	100/50	GS	F W W	A	50
226-81A	Anasorb 747	6 x 70	2	140/70	GS	F W W	A	20

* Limited shelf-life; contact SKC for more information ¥ Anasorb 727 is equivalent to Chromosorb 106.

◇ Limited shelf-life; refrigerator/freezer storage may be required. Contact SKC.

TUBE ENDS: GS: Glass Sealed GO: Glass Open SS: Stainless Steel Open

SEPARATORS: W: Glass Wool G: Glass Fiber Filter F: Foam T: PTFE Ring S: Screen N: Nylon Ring Q: Quartz Filter R: Glass Spacer

For compliance sampling, use tubes as specified in a validated sampling method. It is the user's responsibility, employing a suitable method, to establish appropriate safety and health practices and to determine the applicability of regulatory limitations before use. The user should adjust the sampling parameters for specific conditions and evaluate tubes under conditions of use to ensure that the desired results will be obtained.

Tech Tips

► The approximate surface areas for 20/40-mesh SKC Anasorb 747 and Anasorb CSC sorbents are as follows:

- Anasorb 747 is 980 m²/gm

- Anasorb CSC is 1200 m²/gm

► Q: Is it possible to increase the flow rate of a method to lower the detection limit?

A: NIOSH recommends not exceeding the method-stated maximum flow rate. Instead, sample for a longer period and monitor closely for breakthrough.

Standard of Good Practice

Use inert PTFE tubing to connect two tubes in series or for other applications in which the air sample comes into contact with the tubing before collection onto the sampling media.



For Sample Pumps
see pages 4-29

Sorbent Tube Selection Guide

To select a tube for a specific compound, refer to the SKC Sampling Guide on catalog pages 143-211 or search the online Sampling Guide at www.skinc.com for methods and required sorbent tubes.

Cat. No.	Sorbent (treatment)	Size (mm) OD x L	Sections	Sorbent (mg)	Ends	Separators	Tube Cover	Qty.
226-82	[Anasorb 747 L Anasorb 747	[8 x 110 L 8 x 110	1 1	[400 L 200	GS	[F W L F W	D	20 sets
226-83	Anasorb 747	8 x 110	2	400/200	GS	F W W	B	50
226-84	Anasorb 747	10 x 110	2	800/200	GS	F W W	C	20
226-92*	Polyurethane Foam (PUF)	22 x 100	1	76 mm	GO	—	P	ea
226-93	XAD-4	7 x 70	2	80/40	GS	W W W	B	50
226-94	XAD-7	6 x 70	2	60/30	GS	W W W	A	50
226-95	XAD-7	6 x 110	2	100/50	GS	W W W	B	50
226-96*	XAD-7 ((NBD) chloride)	8 x 110	2	100/50	GS	W W W	B	50
226-97	[XAD-7 (specially cleaned) L XAD-7 (2 tubes)	[8 x 110 L 8 x 110 (2)	1 1	[175 L 175 (2)	GS	[W G W L W W	—	20 sets
226-98*	XAD-7 (phosphoric acid)	6 x 70	2	80/40	GS	W W W	A	50
226-99* (OVS)	Silica Gel/Glass Fiber Filter	13→8 x 75	2	520/260	GO	F F G T	V	10
226-106A	Chromosorb 102	8 x 110	2	200/100	GS	W W W	B	20
226-107	Chromosorb 102	8 x 110	2	100/50	GS	W W W	B	50
226-110	Chromosorb 106	7 x 70	2	100/50	GS	W W W	B	50
226-111A	Chromosorb 106	10 x 150	2	600/300	GS	W W W	C	10
226-114	Porapak-P	6 x 110	2	100/50	GS	F W W	B	50
226-115	Porapak-Q	6 x 110	2	150/75	GS	W W W	B	50
226-116A*	[Porapak-T L Porapak-T	[6 x 40 L 6 x 40	1 1	[75 L 25	GO	[W W L W W	B	10 sets
226-117 [◇]	XAD-2 (2-hydroxymethyl piperidine)	6 x 110	2	150/75	GS	W W W	B	20
226-118 [◇]	XAD-2 (2-hydroxymethyl piperidine)	6 x 110	2	120/60	GS	W W W	B	20
226-119 [◇]	High-purity Silica Gel with low back-ground	6 x 110	2	300/150	GS	W W W	B	20
226-119A [◇]	High-purity Silica Gel with low back-ground (2,4-dinitrophenylhydrazine)	6 x 110	2	300/150	GS	W W W	B	100
226-119-7	High-purity Silica Gel with low back-ground (2,4-dinitrophenylhydrazine)	7 x 110	2	300/150	GS	W W W	B	20
226-120 [◇]	High-purity Silica Gel with low back-ground (2,4-dinitrophenylhydrazine) with built-in ozone scrubber	8 x 115	3	150/ 300/150	GS	W W W W	D	20

* Limited shelf-life; contact SKC for more information ◇ Limited shelf-life; refrigerator/freezer storage may be required. Contact SKC.

TUBE ENDS: GS: Glass Sealed GO: Glass Open

SEPARATORS: W: Glass Wool G: Glass Fiber Filter F: Foam T: PTFE Ring S: Screen N: Nylon Ring Q: Quartz Filter R: Glass Spacer

For compliance sampling, use tubes as specified in a validated sampling method. It is the user's responsibility, employing a suitable method, to establish appropriate safety and health practices and to determine the applicability of regulatory limitations before use. The user should adjust the sampling parameters for specific conditions and evaluate tubes under conditions of use to ensure that the desired results will be obtained.

SKC Formaldehyde SPIKES QC Media

SKC makes laboratory quality control easy with its pre-spiked Formaldehyde SPIKES sorbent tubes. SPIKES are 6 x 110-mm (OD x L) glass-sealed sorbent tubes. Each tube contains two sections (300/150 mg) of high-purity (low-background) silica gel sorbent treated with 2,4-dinitrophenylhydrazine and glass wool separators (W/W). The 300-mg section is spiked with formaldehyde to ± 25% of the stated target level. **Formaldehyde SPIKES are stocked at these commonly requested levels and are sold in packages of 10.**

Spike Level	Cat. No.	Qty.
1.0 µg	227-111	10
3.0 µg	227-112	10
5.0 µg	227-113	10
7.5 µg	227-114	10
10.0 µg	227-115	10

Data Interpretation Formaldehyde

► **LEED Green Buildings**
Formaldehyde Indoor Air
Maximum Concentration:
27 ppb. Maximum concentration in health care facilities is 16.3 ppb.

See formaldehyde sorbent tube
Cat. No. 226-119 or 226-120
at right.

Source: LEED for New Construction Rating
System v4 (U.S. Green Building Council,
<http://www.usgbc.org>)



For continuous
formaldehyde
measurement
see the Formaldehyde
Multimode Monitor on
page 136

Sorbent Tube Selection Guide

To select a tube for a specific compound, refer to the SKC Sampling Guide on catalog pages 143-211 or search the online Sampling Guide at www.skcinc.com for methods and required sorbent tubes.

Cat. No.	Sorbent (treatment)	Size (mm) OD x L	Sections	Sorbent (mg)	Ends	Separators	Tube Cover	Qty.
226-124*	PUF/Tenax TA/PUF	22 x 100	3	3 cm/750 mg/ 3 cm	GO	—	P	ea
226-126*	PUF/Glass Fiber Filter	22 x 100	1	76 mm	GO	F S G N	P	ea
226-129*	PUF/XAD-2/PUF	65 x 125	3	50 mm/10 gm/ 25 mm	GO	—	—	ea
226-131*	PUF	65 x 125	1	75 mm	GO	—	—	ea
226-134*	Tenax TA	16 x 125	1	1.6 gm	GO	W W	—	ea
226-142*	Carbon Beads/PTFE Filter (carbon beads treated with potassium hydroxide)	16→8 x 85	2	100/50	GO	W W W T T	—	5
226-143*	PUF/XAD-2/PUF	22 x 100	3	3 cm/1500 mg/ 3 cm	GO	—	P	ea
226-151 [◇]	Charcoal (proprietary coating)	6 x 70	2	100/50	GS	W W W	A	20
226-153 [◇]	XAD-2 (di-n-butylamine)	8 x 110	2	400/200	GS	W W W	B	20
226-154	Anasorb 747	6 x 70	1	200	GS	W W	A	50
226-165A [◇]	Silica Gel (mercuric cyanide)	6 x 110	2	300/150	GS	W W W	B	20
226-170	XAD-4	6 x 70	1	120	GS	W W	A	20
226-171*	Anasorb 747/Tenax TA	16 x 125	2	5.2 gm/1.2 gm	GO	W W	—	ea
226-175	XAD-4	8 x 150	2	400/200	GS	W W W	—	20
226-176	Silica Gel (hydrochloric acid)	10 x 150	3	700/150/150	GS	W W W W	C	20
226-177 [◇]	Silica Gel (silver nitrate)/Glass Fiber Filter (sodium carbonate/glycerol)	16→8 x 85	2	200/200	GO	T T T W W	—	5
226-178 [◇]	Anasorb 747 (hydrobromic acid)	6 x 70	2	100/50	GS	W W W	A	20
226-182 [◇]	Molecular Sieve (triethanolamine) and oxidizer	10 x 110	3	400/800/400	GS	W W W W	C	50
226-183	Silica Gel (specially washed and baked)/Glass Fiber Filter	$\begin{matrix} 7 \times 110 \\ 7 \times 110 \end{matrix}$	$\begin{matrix} 1 \\ 1 \end{matrix}$	$\begin{matrix} 600 \\ 600 \end{matrix}$	GS	$\begin{matrix} W G W \\ W G W \end{matrix}$	D	20 sets

* Limited shelf-life; contact SKC for more information

◇ Limited shelf-life; refrigerator/freezer storage may be required. Contact SKC.

TUBE ENDS: GS: Glass Sealed GO: Glass Open

SEPARATORS: W: Glass Wool G: Glass Fiber Filter F: Foam T: PTFE Ring S: Screen N: Nylon Ring Q: Quartz Filter

For compliance sampling, use tubes as specified in a validated sampling method. It is the user's responsibility, employing a suitable method, to establish appropriate safety and health practices and to determine the applicability of regulatory limitations before use. The user should adjust the sampling parameters for specific conditions and evaluate tubes under conditions of use to ensure that the desired results will be obtained.

SKC Quality Bulk Sorbents for Laboratory QA/QC Requirements

- Meet stringent specifications for environmental applications
- Undergo extensive cleaning procedures to ensure low backgrounds

Sorbent	Mesh Size	Amount (grams)	Cat. No.
Anasorb CSC	20/40	100	P2260101
Silica Gel	20/40	100	P22610
Tenax GR	20/35	10	P226124
Tenax TA	35/60	10	P226125
	20/35	10	P226126
Anasorb GCB2	20/40	10	P226127
Anasorb GCB1	20/40	10	P226128
	60/80	10	P226132
Anasorb C300	20/40	100	P226171
Anasorb 747	20/40	100	P226200

Standard of Good Practice

► Maintain the sorbent tube in a vertical position when sampling. This position will prevent the sorbent from falling away from the wall of the glass tube and creating a small channel for the air to pass through without adsorbing onto the sorbent.

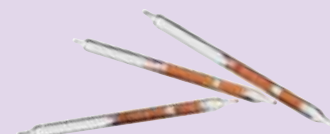

*For Formaldehyde
SPIKES QC media
see page 40*



*For Sample Pumps
see pages 4-29*

Sorbent Tube Selection Guide

To select a tube for a specific compound, refer to the SKC Sampling Guide on catalog pages 143-211 or search the online Sampling Guide at www.skinc.com for methods and required sorbent tubes.

Cat. No.	Sorbent (treatment)	Size (mm) OD x L	Sections	Sorbent (mg)	Ends	Separators	Tube Cover	Qty.
226-186 [◇]	Oxidizer	7 x 110	1	800	GS	W W	B	20
226-188 [◇]	Silica Gel (2,4-dinitrophenylhydrazine)	10 x 110	2	800/200	GS	W W W	C	20
226-191	Silica Gel (o-phenylenediamine)	8 x 110	2	520/260	GS	W W W	B	50
226-192	XAD-2/XAD-2/Anasorb CSC	8 x 110	3	50/100/150	GS	W W W W	B	50
226-193-UC	Silica Gel (MTSO)	7 x 110	1	800	GS	W W	B	20
226-196	Anasorb CSC, Coconut Charcoal (t-butylcatechol)	8 x 110	2	400/200	GS	W W W	B	20
226-199-UC	Silica Gel (MTSO)	8 x 110	2	800/200	GS	W G W	B	20
226-330 [‡]	Anasorb GCB2/GCB1/Carbosieve S-III	6 x 115	3	250/150/100	GO	W W W W	N/A	ea
226-339 [‡]	Tenax TA	1/4 x 3-1/2 in	1	100	GO	W W	N/A	ea
226-340 [‡]	Tenax TA	1/4 x 3-1/2 in	1	100	SS	S W W S	N/A	ea
226-341 [‡]	Carbosieve S-III	1/4 x 3-1/2 in	1	100	SS	S W W S	N/A	ea
226-345 [‡]	Tenax GR/Anasorb GCB1	1/4 x 3-1/2 in	2	125/120	GO	W W W	N/A	ea
226-346 [‡]	Anasorb GCB1/Carbosieve S-III	1/4 x 3-1/2 in	2	175/80	GO	W W W	N/A	ea
226-347 [‡]	Anasorb GCB2/GCB1/Carbosieve S-III	1/4 x 3-1/2 in	3	120/125/105	GO	W W W W	N/A	ea
226-348 [‡]	Tenax GR/Anasorb GCB1	1/4 x 3-1/2 in	2	175/150	SS	O S W S O	N/A	ea
226-349 [‡]	Anasorb GCB1/Carbosieve S-III	1/4 x 3-1/2 in	2	280/165	SS	S W S	N/A	ea
226-350 [‡]	Anasorb GCB2/GCB1/Carbosieve S-III	1/4 x 3-1/2 in	3	210/140/165	SS	S W W W S	N/A	ea
226-356 [‡]	Anasorb GCB1	1/4 x 3-1/2 in	1	400	SS	S W W S	N/A	ea
226-357 [‡]	Tenax TA	1/4 x 3-1/2 in	1	250	SS	S W W S	N/A	ea
226-358 [‡]	Chromosorb 106	1/4 x 3-1/2 in	1	350	SS	S W W S	N/A	ea
226-360 [‡]	Tenax TA	1/4 x 3-1/2 in	1	250	GO	W W	N/A	ea
226-363 [‡]	Carbopack X	1/4 x 3-1/2 in	1	400	SS	S W W S	N/A	ea

‡ Tubes are chemically purged before shipping; use within 6 months or recondition, restocking fee applies. ∞ Available unpurged, see page 47
 § Each tube has a flow direction arrow and unique number. ◇ Limited shelf-life; refrigerator/freezer storage may be required. Contact SKC.

TUBE ENDS: GS: Glass Sealed GO: Glass Open SS: Stainless Steel Open

SEPARATORS: W: Glass Wool G: Glass Fiber Filter F: Foam T: PTFE Ring S: Screen N: Nylon Ring O: Other Q: Quartz Filter

For compliance sampling, use tubes as specified in a validated sampling method. It is the user's responsibility, employing a suitable method, to establish appropriate safety and health practices and to determine the applicability of regulatory limitations before use. The user should adjust the sampling parameters for specific conditions and evaluate tubes under conditions of use to ensure that the desired results will be obtained.

SKC Sampling Media and Pump for Peracetic Acid (PAA)



SKC offers the sampling media and pump required for sampling PAA according to the French Institut National de Recherche et de Sécurité (INRS) method for the simultaneous measurement of PAA and hydrogen peroxide (HP). Method media include sorbent tubes containing sorbent treated with high-purity MTSO reagent for ultra-low background (see Cat. Nos. 226-193-UC and 226-199-UC above), quartz filters coated with titanium oxysulfate hydrate in 25-mm cassette (see Cat. No. 225-9030 on page 65), and AirChek XR5000 sample pump (see pages 14-15) to provide the 1 L/min flow rate at higher back pressure. PAA is analyzed by high-performance liquid chromatography with UV detection and HP by molecular absorption spectrometry.

Contact SKC for the latest updates on OSHA methods in development for PAA and hydrogen peroxide.

Standard of Good Practice

Store and prepare sampling media in solvent-free environments.

Tube Breakers

Description	Cat. No.
Tube Breaker/Capper , stainless steel Size S, 6 and 7-mm OD tubes 	222-3-50
Size L, 8 and 10-mm OD tubes	222-3-51
Tube Scorer/Breaker , for 6-mm OD tubes; scores and breaks end tips off glass tubes, leaving a clean, smooth opening 	800-01200



For Thermal Desorption Tubes purged by SKC or your lab see page 47

OSHA Versatile Sampler (OVS) Tubes For Sampling Pesticides, Explosives, and Glycols

- Sorbent and filter combined in one tube
- Collect aerosols and vapors simultaneously
- Low backgrounds ensure sample integrity
- Meet OSHA and NIOSH method design specifications
- Eliminate the need for cumbersome filter and tube sampling trains
- Available with a variety of sorbents
- Easy-off hat caps

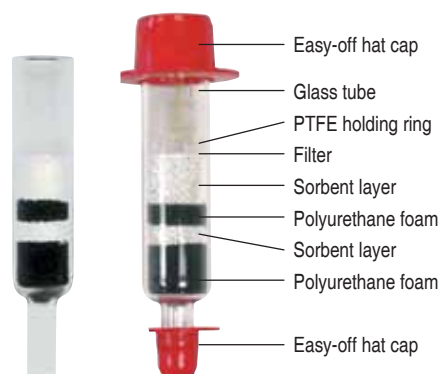

OSHA originally designed OSHA Versatile Sampler (OVS) Tubes to overcome the inconveniences of earlier methods. SKC OVS Tubes contain a filter to trap aerosols and a two-section sorbent bed to adsorb vapors in one specially constructed glass tube that eliminates cumbersome filter and tube sampling trains. Only cleaned and verified materials are used in OVS Tubes to ensure low background interference. A flow rate of 1 L/min provided by a personal sample pump is typically used to obtain volumes ranging from 60 to 480 liters. Samples are solvent extracted and analyzed by GC or HPLC with detector.

Available with a variety of sorbent and filter combinations, SKC OVS Tubes are truly versatile for sampling applications and methods including pesticides such as DDVP (dichlorvos), carbaryl (Sevin), chlorpyrifos (Dursban), Diazinon, malathion, and parathion; explosives such as TNT and DNT; alcohols such as glycols; and biocides.

Application — Method	Sorbent (mg)	Filter	Cat. No.	Qty.
Pesticides — OSHA 62, 63, 67, 70, 74, OSHA CSI			226-30-16	10
Organotin Compounds* — OSHA CSI	XAD-2 (270/140)	Glass fiber	226-30-16A	50
Pesticides, organophosphorus — NIOSH 5600, 5601, 5602	XAD-2 (270/140)	Quartz fiber	226-58 226-58A	10 50
Explosives (trinitrotoluene [TNT] and dinitrotoluene [DNT]) — OSHA 44				
Phthalate Esters — OSHA 104				
Acrylates and Benzophenone — Non-agency method [†]	Tenax TA (140/70)	Glass fiber	226-56	10
Caprolactam Vapor — OSHA CSI			226-57	10
Glycols — NIOSH 5523	XAD-7 (200/100)	Glass fiber	226-57A	50
Kathon 886 Biocide — Non-agency method [‡]	Silica gel (520/260)	Glass fiber	226-99	10
Accessories				
OVS Tube Holder includes 0.9 meter (3 feet) of tubing and collar clip, <i>see details at above right</i>			224-29V	ea
OVS Adapter Kit includes tubing and adapter for calibration of OVS Tubes			224-31	ea

* Methyl tin mercaptide, stannous-2-ethyl hexanoate, butyltin trichloride † See Ref. 39 on page 213. ‡ See Ref. 55 on page 213.



OVS Tube Holder

OSHA Versatile Sampler Tubes are typically used at a flow rate of 1 L/min provided by a personal sample pump. The special OVS Tube Holder is designed to accommodate the tube's 13-mm diameter, provide a convenient clip to attach the tube in the breathing zone, and protect the tube during sampling.

OVS Tube Holder includes fitting with durable protective cover, 0.9 meter (3 feet) of tubing, and collar clip
Do not use an Adjustable Low Flow Holder
Cat. No.224-29V

Specialty Sorbent Tubes

Low-volume PUF

ABOUT

Repacking Service and Replacement Parts

Repacking service for Low-volume PUF Tubes includes cleaning the glass, packing it with new sorbent/PUF, and inserting it into a cleaned storage bottle.

Contact SKC for an RA number and decontamination form.

Repack for Cat. No. 226-92
New PUF packed into cleaned original glass and inserted into cleaned storage bottle
Cat. No.P22692R

Replacement PUFs for Cat. No. 226-92
Uncleaned, 76-mm length, pk/20
Cat. No.P22692

Repack for Cat. No. 226-143
New PUF/sorbent packed into cleaned original glass and inserted into cleaned storage bottle
Cat. No.P226143R

Repack for Cat. No. 226-126
New PUF/filter packed into cleaned original glass and inserted into cleaned storage bottle
Cat. No.P226126R

Repack for Cat. No. 226-124
New PUF/sorbent packed into cleaned original glass and inserted into cleaned storage bottle
Cat. No.P226124BV

24-hour Sampling?



Use Low-volume PUF Tubes with the Leland Legacy Sample Pump at 5 L/min see pages 22-23

Low-volume PUF Tubes

For Sampling Semi-volatiles from 1 to 5 L/min

- For measurements up to 24 hours
- Custom PUF/sorbent combinations available
- Precleaned and ready to use
- Meet specifications of EPA Method TO-10A, EPA IP-8, ASTM D4861, and ASTM D4947
- Can be repacked and recertified by SKC

Sample Time:	4 to 24 hours
Sample Rate:	1 to 5 L/min
Sample Pump:	XR Series, AirChek Series, or Leland Legacy

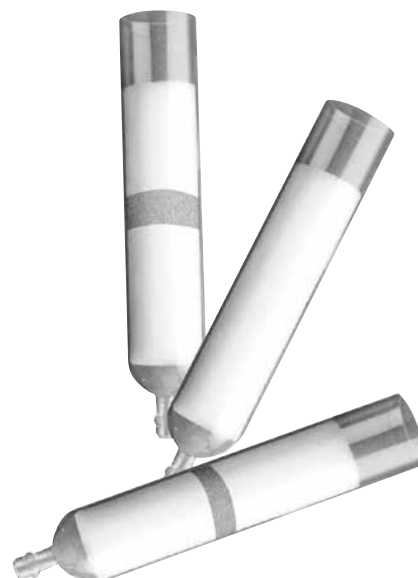

SKC Low-volume PUF Tubes contain polyurethane foam (PUF) or PUF/sorbent combinations that meet the specifications of EPA and ASTM indoor and ambient air sampling methods for pesticides in homes, public buildings, and offices. The methods specify the use of a sample pump, operating at a flow rate of 1 to 5 L/min, to draw air through the PUF tube to sample concentrations as low as 0.001 mg/m³. Collection times vary from 4 to 24 hours. See pages 8-10 and 14-23 for sample pump information.

Precleaned and ready to use, SKC Low-volume PUF Tubes are convenient and can be repacked and recertified to save money and recycle glass. See above left.

Low-volume PUF Tubes

Methods	Compounds	Sorbent (Amount)	Cat. No.
EPA TO-10A, IP-8	Organochlorine and organophosphorus pesticides, carbamate, pyrethrin, triazine, and urea pesticides	PUF (76 mm)	
ASTM D4861	Organochlorine and organophosphorus pesticides and PCBs		
ASTM D4947	Chlordane and heptachlor residues		226-92
ASTM D4861	Organochlorine and organophosphorus pesticides and PCBs	PUF/Tenax/PUF (30 mm/750 mg/30 mm)	
EPA TO-10A	Organochlorine and organophosphorus pesticides, carbamate, pyrethrin, triazine, and urea pesticides		226-124
Custom	Pesticides, PCBs, and PAHs	PUF/XAD-2/PUF (30 mm/1500 mg/30 mm)	226-143
Custom	Pesticides, PCBs, and PAHs	PUF/glass fiber filter (76 mm)	226-126
Accessories			
Tube Holder for Low-volume PUF Tubes, see p. 50 for details			224-29P
Multi-purpose Calibration Jar, see p. 104 for details			225-111

Note: PUF tubes used in the Statements of Work for Superfund sites must be used and analyzed within 14 days of being cleaned.

High-volume PUF Tubes

For Sampling Semi-volatiles from 220 to 280 L/min

SKC High-volume PUF and PUF/sorbent combination tubes are designed for use with high-volume samplers to meet EPA and ASTM method specifications for ambient air sampling of organochlorine pesticides, polychlorinated biphenyls (PCBs), and polycyclic aromatic hydrocarbons (PAHs).

► Combination PUF/XAD-2 sorbent tube

- Meets EPA Method 600/8-80-038 specifications
- Contains cleaned XAD-2 sorbent between two PUFs
- XAD-2 sorbent improves volatile component extraction during analysis

► PUF-only sorbent tube

- Meets ASTM D6209, EPA IP-7, TO-4A, TO-9A, and TO-13A
- Packed with precleaned PUF for low background



SKC High-volume PUF Tubes are cleaned and ready to use.

Custom PUF Tubes

You provide the specifications, SKC will provide the tubes. Custom PUF, PUF/sorbent combination, and PUF/filter combination tubes are available.

Contact SKC with your specifications — www.skcinc.com, search on “custom.”

High-volume PUF Tubes

Methods	Compounds	Sorbent (Amount)	Cat. No.
EPA 600/8-80-038	Organochlorine pesticides, PCBs	PUF/XAD-2/PUF (50 mm/10 gm/25 mm)	226-129
Non-agency [‡]	Nonpolar organic compounds		
EPA IP-7, TO-4A, TO-9A, TO-13A	Organochlorine pesticides, dioxins and furans, PCBs, PAHs	PUF (75 mm)	226-131
ASTM D6209	Polycyclic aromatic hydrocarbons		

Note: PUF tubes used in the Statements of Work for Superfund sites must be used and analyzed within 14 days of being cleaned.

[‡] See Non-agency Method 38 on page 213.

Repacking Service and Replacement Parts

Repacking service for High-volume PUF Tubes includes cleaning the glass, packing it with new sorbent and/or PUF, and inserting it into a cleaned storage bottle. Contact SKC for an RA number and decontamination form.

Description	Cat. No.	Qty.
Repack for Cat. No. 226-129 includes new PUF/sorbent packed into cleaned original glass and inserted into cleaned storage bottle	P226129R	ea
Replacement PUF for Cat. No. 226-129, uncleaned	25-mm length P226129A	10
	50-mm length P226129B	10
Repack for Cat. No. 226-131 includes new PUF packed into cleaned original glass and inserted into cleaned storage bottle	P226131R	ea
Replacement PUF for Cat. No. 226-131, 75-mm length	Uncleaned P226131	10
	Cleaned P226131C	10
Glass Cartridge with support screens for Cat. No. 226-129 or 226-131	P226129C	ea

Quartz Filters for High-volume PUF Sampling

Description	Cat. No.	Qty.
QM-A, high-purity microfibers, 450- μ m thickness, 102-mm diameter	225-1808	100



For sampling PAHs, PCBs, pesticides, and associated particulate at 10 L/min
see pages 24-25

Sorbent Tubes

Active/Passive Method Cross-reference

Custom Sorbent Samplers from SKC

SKC can make the media needed for in-house methods or SOPs at competitive prices!

- > PUF, PUF/sorbent, and PUF/filter cartridges
- > Multi-bed sorbent tubes
- > Sorbent repacks or refills
- > Tubes for thermal or solvent desorption
- > Glass or stainless steel construction



Go to www.skcinc.com and enter "Custom Tubes" in the search bar

Active/Passive Method Cross-reference

SKC sorbent tubes are specified in many active sampling methods. In recent years, OSHA has developed eight diffusive sampling methods in which SKC passive samplers are specified for sampling the same compounds of interest as active methods. Passive sampling saves deployment time and money as no pump is needed. Check the method to determine if passive sampling is an option for your application. *See the table below for passive alternatives to active sorbent tubes.*

Compound	Active Method/ Tube Cat. No.	Pg. No.	Passive Method/ Sampler Cat. No.	Pg. No.
Benzene	OSHA 1005		OSHA 1005	
	226-01	38	575-002	75-76
Butyl acetates	OSHA 1009		OSHA 1009	
	226-01	38	575-002	75-76
Formaldehyde	NIOSH 2016		OSHA 1007	
	226-119/226-120	40	500-100	84
Hydrogen cyanide	NIOSH 6010		OSHA 1015	
	226-28	38	590-400	86
MEK/MIBK	OSHA 16 (MEK)		OSHA 1004	
	226-10	38	575-002	75-76
Mercury	OSHA ID-140		OSHA ID-140	
	226-17-1A	38	520-03/02A	86
Styrene	OSHA 89		OSHA 1014	
	226-73	39	575-006	75-76
Toluene	OSHA 111		OSHA 111	
	226-81A or			
	226-01	38-39	575-002	75-76
Trichloroethylene/ tetrachloroethylene	OSHA 1001		OSHA 1001	
	226-01	38	575-002	75-76
Xylenes/ethylbenzene	OSHA 1002		OSHA 1002	
	226-01	38	575-002	75-76



VOC Chek 575
Passive Samplers
for ppm-Level
Organic Vapors
OSHA Methods 1001,
1002, 1004, 1005,
1009, 1014, and 111

500-100 UME^x 100
Passive Sampler for
Formaldehyde

OSHA Method 1007

590-400 Passive
Sampler for HCN

OSHA Method 1015

520-03/02A Passive
Sampler for Inorganic
Mercury

OSHA Method ID-140



More Information

For a list of laboratories
analyzing SKC sample media,
visit www.skcinc.com

Thermal Desorption Sorbent Tubes For Sub-ppb VOC Measurements

SKC offers single and multiple-bed thermal desorption tubes that meet EPA Method TO-17 requirements for the determination of VOCs in ambient air. All SKC thermal desorption tubes are sealed with PTFE end caps and marked with a permanent serial number. **SKC offers two options for thermal desorption tubes: purged or unpurged (UP).** Purchase SKC thermally purged thermal desorption tubes for immediate use in the field. Purchase unpurged tubes for thermal purging by your laboratory as needed. Glass transport tubes and Swagelok fittings are available as accessories.

Perkin Elmer or Markes International Thermal Desorber Tubes

Available in **glass or stainless steel**, these tubes measure 6.35-mm OD x 88.9-mm length (1/4-inch OD x 3 1/2-inch length).

Method	Sorbent	SS	SS	Glass	Glass
		Purged	Unpurged	Purged	Unpurged
		Cat. No.	Cat. No.	Cat. No.	Cat. No.
ASTM D6196	Anasorb GCB1*	226-356	226-356-UP	—	—
ASTM D6196; MDHS 72	Tenax TA	226-357	226-357-UP	226-360	226-360-UP
ASTM D6196; MDHS 72	Chromosorb 106	226-358	226-358-UP	—	—
EPA TO-1, IP-1B	Tenax TA	226-340	226-340-UP	226-339	226-339-UP
EPA TO-2	Carbosieve S-111	226-341	226-341-UP	—	—
EPA TO-17	Anasorb GCB1*/Carbosieve S-111	226-349	226-349-UP	226-346	226-346-UP
EPA TO-17, NIOSH 2549	Anasorb GCB2*/Anasorb GCB1*/ Carbosieve S-111	226-350	226-350-UP	226-347	226-347-UP
EPA TO-17	Tenax GR/Anasorb GCB1*	226-348	226-348-UP	226-345	226-345-UP
	Carbopack X	226-363	226-363-UP	—	—

Screening Tubes (Fit Dynatherm Thermal Desorber)

Available in **glass**, these tubes measure 6-mm OD x 115-mm length (0.24-inch OD x 4.5-inch length).

Method	Sorbent		Cat. No.	Qty.
EPA IP 1B, NIOSH 2549	GCB2*/GCB1*/Carbosieve S-111	Purged	226-330	ea
		Unpurged	226-330-UP	ea

* Anasorb GCB1 is equivalent to Carbopack B; Anasorb GCB2 is equivalent to Carbopack C.

Accessories

Description	Cat. No.	Qty.
Glass Transport Tubes , for 88.9-mm (3 1/2-inch) length tubes	226-300	5
PTFE Ferrules , set of 2	P30121	ea
Swagelok Fittings , for 6.35-mm (1/4-inch) OD tubes, set of 2	P50291	ea



Swagelok Fittings available,
see below left for ordering

Standard of Good Practice

► It is a standard of good practice to purge thermal desorption tubes before each use.

New!



For Passive Thermal
Desorption Tubes,
see pages 48-49



For Sample Pumps,
see pages 4-29

Traps for Volatile Organic Sampling Trains (VOSTs)

VOSTs are specified by U.S. EPA 0031 in SW-846 for sampling VOCs in gaseous effluent from stationary emission sources such as hazardous waste incinerators. SKC VOST traps meet method specifications, are tested for background and pressure drop, and feature Swagelok fittings and PTFE ferrules. Traps are **not** supplied thermally purged. See note below.

Method	Sorbent (gm)	Description	Cat. No.
EPA 0031	Tenax TA, 35/60 mesh (1.6)	Glass open, 16-mm OD x 125-mm L	226-134†

† Limited shelf-life **Note:** VOST traps must be purged prior to use. Use and analyze within 14 days of conditioning.

Specialty Sorbent Tubes

Diffusive TD Tubes for BTEX/Other VOCs

Diffusive Thermal Desorption Tubes Time-averaged Assessment of BTEX and Other VOCs

- Validated sampling rates for benzene, toluene, ethylbenzene, xylenes, and many other VOCs
- Contain pre-conditioned Carboxpack® X sorbent
- SilcoNert® 2000 deactivated 3.5 x 0.25-inch OD stainless steel tubes
 - Ideal for protecting sample integrity over long sampling periods
- Use to determine average concentration over longer sampling periods up to 14 days
- No pump or training required
- Reusable to keep costs low
- Unique identification number and bar code
- Weatherproof tube shelter available
- Airflow and cap placement arrow indicators printed on tube
- Sealed with brass Swagelok screw caps with PTFE ferrules for transport
- Each collected compound can be analyzed quantitatively

SKC Diffusive Thermal Desorption (TD) Tubes are designed to provide accurate sampling of VOCs at refinery fencelines and for other ambient air monitoring applications without the use of a sample pump. Sampling times of up to 14 days provide an average concentration that eliminates the effects of daily variables such as hazard concentration and temperature. A weatherproof shelter accessory protects samples.



Description	Cat. No.	Qty.
SKC Diffusive TD Tubes, * 3.5 x 0.25-in OD deactivated stainless steel tubes filled with pre-conditioned Carboxpack X and supplied with diffusion caps and brass Swagelok screw caps with PTFE ferrules	226-520	10
Diffusion Caps	226-525	10
Shelter	226-526	ea

* Tubes must be used within 30 days of conditioning

SKC Diffusive Thermal Desorption Tubes for BTEX and Other VOCs

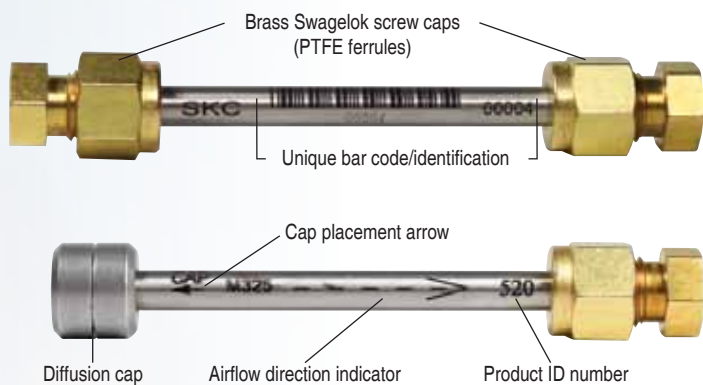

SKC Diffusive TD Tubes are conditioned and quality control tested to assure low background.



Weatherproof shelter accessory protects TD tubes.



More Information

McClenny, W.A. et al., "24 h Diffusive Sampling of Toxic VOCs in Air onto Carbopack X ..." <http://doi.org/fhgn4s>

U.S. EPA Method 325B: <https://goo.gl/B4viuV>

www.skinc.com

Low Flow Sampling Accessories

Single-tube Holders

Single-tube Low Flow Sampling Accessories

Build a **single-tube low flow sampling train** in three easy steps: (1) select a pump, (2) select the pump specific tube holder, and (3) select a protective tube cover (based on sorbent tube size, *see Sorbent Tube Selection Guide on pages 38-42*). Pocket Pump TOUCH holders are supplied with protective tube covers.

Step 1	Step 2	Step 3
Pumps AirChek 52/Sidekick AirChek 3000 AirChek XR5000 AirChek TOUCH AirLite	All-in-One Low Flow Single Tube Holder Cat. No. 224-27 	Tube Covers A (6-mm OD x 70-mm L) Cat. No. 224-29A  B (8-mm OD x 110-mm L) Cat. No. 224-29B  C (10-mm OD x 150-mm L) Cat. No. 224-29C  D (10-mm OD x 220-mm L) Cat. No. 224-29D  <i>Select desired tube from the Sorbent Tube Selection Guide on pp. 38-42. Match the letter indicated in the Tube Cover column in the Guide to the letter above.</i>
Universal Series	Adjustable Low Flow Tube Holder Cat. No. 224-26-01 	
Pocket Pump TOUCH	Low Flow Tube Holder with cover (non-adjustable) Cat. No. 222-3-1 (A)  222-3L-1 (B) 222-3XL-1 (C) 222-3XD-1 (D)	with A (6-mm OD x 70-mm L)  with B (8-mm OD x 110-mm L)  with C (10-mm OD x 150-mm L)  with D (10-mm OD x 220-mm L) 

Specialty Tube Holders

For Sorbent Sampling ≥ 1 L/min Without Low Flow Controller

OVS Tube Holder

The OVS Tube Holder accommodates the 13-mm diameter of SKC OVS Tubes.

OVS Tube Holder includes fitting with durable protective cover, 3 feet of tubing, and collar clip. *Do not use an Adjustable Low Flow Holder*

Cat. No. 224-29V



Low-volume PUF Tube Holder

The Low-volume PUF Tube Holder accommodates the 22-mm diameter and 100-mm length of SKC Low-volume PUF Tubes.











Low-volume PUF Tube Holder includes fitting with durable protective cover, 3 feet of tubing, and collar clip. *Do not use an Adjustable Low Flow Holder*

Cat. No. 224-29P



Multiple-tube Low Flow Sampling Accessories

Build a **multiple-tube low flow sampling train** in four easy steps: (1) select a pump, (2) select the constant pressure controller (if pump requires it), (3) select a tube holder, and (4) select protective tube covers (based on sorbent tube size, *see Sorbent Tube Selection Guide on pages 38-42*).

Step 1	Step 2	Step 3	Step 4	
Pumps AirChek 52/Sidekick AirChek 3000 AirChek XR5000 AirChek TOUCH AirLite	Constant Pressure Controller (CPC) CPC Cat. No. 224-26CPC 	Adjustable Multiple-tube Low Flow Holders 2 tubes (Dual) Cat. No. 224-26-02  3 tubes (Tri) Cat. No. 224-26-03  4 tubes (Quad) Cat. No. 224-26-04 	Tube Covers A (6-mm OD x 70-mm L) Cat. No. 224-29A  B (8-mm OD x 110-mm L) Cat. No. 224-29B  C (10-mm OD x 150-mm L) Cat. No. 224-29C  D (10-mm OD x 220-mm L) Cat. No. 224-29D  Select desired tube from the Sorbent Tube Selection Guide on pages 38-42. Match the letter indicated in the Tube Cover column in the Guide to the letter above.	 
Universal Series	None required (pump has built-in regulator)			

Sampling/Analysis Accessories



Tool Kit

Includes scissors, pliers, file, 2 slotted screwdrivers, 2 Phillips screwdrivers, forceps, and charcoal pick

Cat. No.376-01-01



Sampling Labels

Identify samples with sample number, date, flow, pump number, time on, and time off, pk/500

Cat. No.225-1370

Septum Vials

Glass vials (3.7-ml) with screw-on molded plastic caps; fit Vial Rack Cat. No. 226-04-1. *Vial racks are not included. Contact SKC for ordering information on racks.*



Septum Vials, 3.7 ml, pk/100

Cat. No.226-02A

SKC Sample Bags

Bag Materials Expand Sampling Options

SKC Sample Bags

In addition to the classic Tedlar bag, SKC provides the world's largest selection of bags in materials for various compounds in stock and ready for shipment. SKC sample bags are constructed of low-background top-grade bag materials with evenly sealed leak-free seams and high-quality bag fittings.

Make the Best Choice!

SKC publishes performance data on its bag materials to equip you with the knowledge you need to make the best choice. See www.skcinc.com/instructions/1805.pdf for information.



**WORLD'S
LARGEST
SELECTION OF
BAG MATERIALS!**

Choose the Best Bag for Your Application

Tedlar

- ▶ Classic DuPont film
- ▶ Good stability for VOCs, CO, CO₂, methane, SF₆, and some sulfur compounds including hydrogen sulfide



Pages 54-55

Standard FlexFoil®

- ▶ Effectively retains hydrogen sulfide for 48 hours!
- ▶ Good light and moisture barrier properties
- ▶ Good stability for CO, CO₂, methane, hydrogen, hydrogen sulfide, carbonyl sulfide, methyl and ethyl mercaptan, and sulfur hexafluoride (SF₆)



Page 56

FlexFoil PLUS

- ▶ All the benefits of Standard FlexFoil — PLUS...
 - Low VOC backgrounds
 - Good stability for VOCs
 - Suitable for collecting low ppm to high ppb-level VOCs
 - New bags for breath-gas analysis!



Page 57

SamplePro® FlexFilm

- ▶ Low VOC background
- ▶ Good stability for many VOCs, CO, CO₂, methane, and sulfur hexafluoride (SF₆)
- ▶ Acceptable stability for some sulfur compounds
- ▶ Not recommended for hydrogen sulfide and carbonyl sulfide
- ▶ Most economical option
- ▶ Requires flat storage and transport for sample integrity



Page 58

Bag Stability Data

Want to know the stability of specific compounds in different types of film? Access the SKC Bag Stability Report at www.skcinc.com/instructions/1805.pdf.

SKC Quality Bag Films

SKC manufactures and stocks high-quality 2-mil DuPont Tedlar, 3-mil SamplePro FlexFilm, and 5-mil 4-ply FlexFoil sample bags. Seams are strong, evenly sealed, and leak tested.

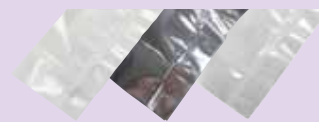

ABOUT

SKC Superior Bag Fittings

SKC stocks sample bags with a choice of fittings to meet your applications. SKC bag fittings are designed specifically for industrial hygiene and environmental air sampling. Choose from dual stainless steel or all-in-one polypropylene, stainless steel, or PTFE fittings that combine the hose/valve and septum into one lightweight, economical fitting.



**For Bag
Sampling Pumps**
see page 60

ABOUT

Breath-gas Analysis Bags

ACGIH lists Biological Exposure Indices (BEIs) determined by end-exhaled air for methyl chloroform, tetrachloroethylene, and trichloroethylene. SKC Breath-gas Analysis Bags are also ideal for collecting samples of human breath to be analyzed for volatile organic compounds (VOCs) or volatile sulfur compounds (VSCs), possible biomarkers for some diseases. **SKC Breath-gas Analysis Bags are offered in Tedlar and FlexFoil PLUS (page 57).** See www.skinc.com/instructions/1805.pdf for information on bag material stability.



For PTFE Tubing
see page 60



More Information

SKC Bag Stability Report –
www.skinc.com/instructions/1805.pdf
www.skinc.com

Classic Tedlar Bags for VOCs The Flexibility of Dual Stainless Steel Fittings

- ▶ **Dual stainless steel fittings provide complete sampling flexibility**
 - Bags are configured with one hose/valve fitting and one septum fitting
- ▶ **Reliable, inert stainless steel fitting construction prevents leakage**
- ▶ **Stocked in a variety of sizes; custom bags available**
- ▶ **Bag available for EPA TCLP method**
- ▶ **Breath-gas analysis bags for end-exhaled air determined BEIs and medical applications (see left)**

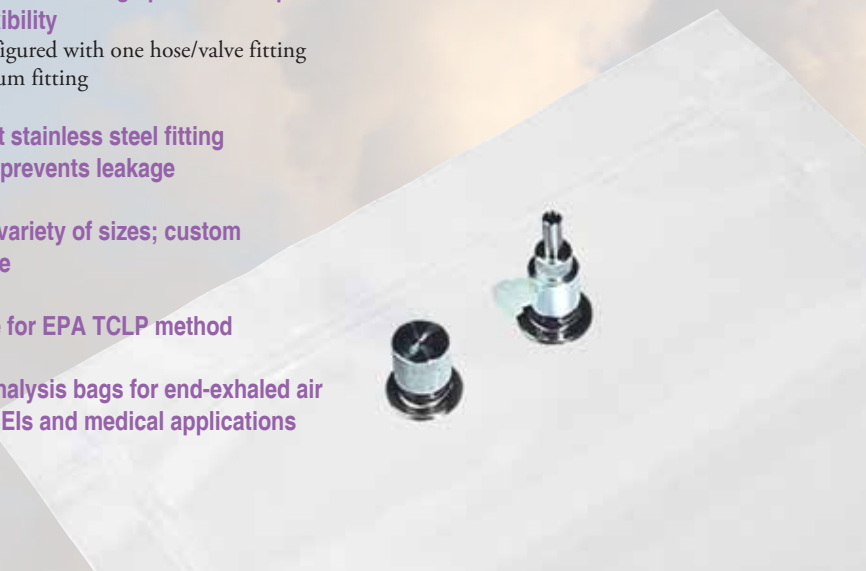

Tedlar Bags with Dual Stainless Steel Fittings

Maximum Capacity (liter)	Cat. No.	Qty.	Fitting
1	231-01 231-01A	10 ea	
3	231-03	10	
5	231-05 231-05A	10 ea	
10	231-10	10	
25	231-25	5	
50	231-50	5	
75	231-75	5	
100	231-100	3	
Replacement Septa	231-9-04	10	

Tedlar Bag with Single Stainless Steel Septum Fitting (attaches to ZHE)

Description	Cat. No.	Qty.	Fitting
Tedlar Sample Bag, 1 liter , with single stainless steel septum fitting suitable for attaching directly to Zero Head-space Extractor (ZHE) with stainless steel adapter, <i>required</i>	231-01-TCLP	10	
Stainless Steel Adapter , for use with ZHE, <i>required</i>	231-01-ZHE	ea	

Tedlar Bag with Stainless Steel Breath-gas Analysis Fitting

Description	Cat. No.	Qty.	Fitting
Tedlar Sample Bags, 1 liter , each with stainless steel fitting and individually packaged clean mouthpiece, see <i>About above left</i>	249-01	5	

Classic Tedlar Bags for VOCs

Convenient and Economical Single Polypropylene Fitting

- ▶ **Single combined polypropylene fitting**
 - Combines the septum and hose/valve into one fitting
- ▶ **An industry standard!**
- ▶ **Economical**
- ▶ **Single lightweight fitting provides easy bag handling**
- ▶ **Stocked in a variety of sizes; custom bags available**

Performance Profile

Background

Moderately low VOC

Stability

Good for VOCs, some sulfur compounds (including H₂S), CO, CO₂, methane, and SF₆

Thickness

2 mil

Sample Pump

Grab Air or Pocket Pump TOUCH, see pp. 60-61

Most Popular Bag!

Tech Tips

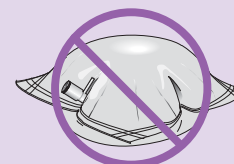

Incorrect inflation

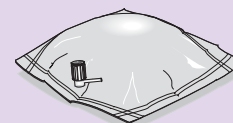

Correct inflation



For Bag Sampling Pumps
see page 60



For Vac-U-Chamber
see pages 62-63

Tedlar Bags with Single Polypropylene Fitting

Maximum Capacity (liter)	Cat. No.	Qty.	Fitting
0.5	232-02	10	
0.7	232-945A	10	
(Fits Vac-U-Tube Cat. No. 231-945)			
1	232-01	10	
(Fits small Vac-U-Chamber Cat. No. 231-940)	232-01A	ea	
3	232-03	10	
	232-03A	ea	
5	232-05	10	
	232-05A	ea	
8	232-939	10	
(Fits large Vac-U-Chamber Cat. No. 231-939)			
10	232-10	10	
(Fits extra-large Vac-U-Chamber Cat. No. 231-944)	232-10A	ea	
25	232-25	5	
(Fits jumbo Vac-U-Chamber Cat. No. 231-946)			
50	232-50	5	
75	232-75	5	
100	232-100	3	
Replacement Septa	232-01-RS	10	

Tedlar Bag with Polypropylene Breath-gas Analysis Fitting

Description	Cat. No.	Qty.	Fitting
Tedlar Sample Bags, 1 liter, each with polypropylene fitting, fitting adapter, and individually packaged clean mouthpiece, see About on p. 54	249-01-PP	5	

ABOUT

Standard FlexFoil Applications

- CO₂ — OSHA Method ID-172
- CO₂ — NIOSH 6603
- CO — OSHA ID-210[‡]
- Sulfur compounds
- Indoor air studies (CO, CO₂, SF₆)

[‡] OSHA ID-210 specifies 5-layer foil bags. SKC 4-ply FlexFoil bags hold 100 ppm CO for 5 days without loss. See www.skinc.com/instructions/1706.pdf for more information.



More Information

SKC Bag Stability Report –
www.skinc.com/instructions/1805.pdf
www.skinc.com

Standard FlexFoil Sample Bags

Superior Bag for Sulfur Compounds and Low Molecular Weight Gases

- Effectively retain hydrogen sulfide for 48 hours!
- Strong, flexible, evenly sealed seams
- Lightproof and moistureproof
 - Excellent for light-sensitive compounds
- Choice of all-in-one polypropylene or stainless steel hose/valve and septum fittings
- Stocked in a variety of sizes
- Custom bags available

Performance Profile

Background

Moderate to high VOC and low sulfur

Stability

Good for CO, CO₂, methane, hydrogen, and SF₆. Good 48-hour stability for hydrogen sulfide, hydrogen, carbonyl sulfide, and methyl and ethyl mercaptan

Thickness

4 ply (5 mil)

Sample Pump

Grab Air or Pocket Pump TOUCH, see pp. 60-61
 Also see the Vac-U-Chamber on pp. 62-63.

Standard FlexFoil Bags with Single Polypropylene Fitting

Maximum Capacity (liter)	Cat. No.	Qty.	Fitting
1 <i>(Fits small Vac-U-Chamber Cat. No. 231-940)</i>	262-01 262-01A	10 ea	
3	262-03 262-03A	10 ea	
5	262-05	10	
8	262-08	10	
<i>(Fits large Vac-U-Chamber Cat. No. 231-939)</i>			
10 <i>(Fits extra-large Vac-U-Chamber Cat. No. 231-944)</i>	262-10	10	
25 <i>(Fits jumbo Vac-U-Chamber Cat. No. 231-946)</i>	262-25	5	
50	262-50	5	
Replacement Septa	236-01-RS	10	

Standard FlexFoil Bags with Single Stainless Steel Fitting

Maximum Capacity (liter)	Cat. No.	Qty.	Fitting
1	263-01 263-01A	10 ea	
3	263-03 263-03A	10 ea	
5	263-05	10	
10	263-10	10	
25	263-25	5	
50	263-50	5	
Replacement Septa	233-01-RS	10	

FlexFoil PLUS Sample Bags

Specially Cleaned for Low ppm to High ppb-Level VOCs

- All the benefits of Standard FlexFoil — PLUS detection and good storage stability for low ppm to high ppb-level VOCs
- Strong, flexible, evenly sealed seams
- Lightproof and moistureproof
 - Excellent for light-sensitive compounds
- Choice of all-in-one polypropylene or stainless steel hose/valve and septum fittings
- Stocked in a variety of sizes
- Custom bags available
- Breath-gas analysis bags are available in FlexFoil PLUS

Performance Profile

Background

Low VOC and sulfur (*specially cleaned*)

Stability

Good for low ppm to high ppb-level VOCs

Good for CO, CO₂, methane, hydrogen, and SF₆
 Good 48-hour stability for hydrogen sulfide, hydrogen, carbonyl sulfide, and methyl and ethyl mercaptan

Thickness

4 ply (5 mil)

Sample Pump

Grab Air or Pocket Pump TOUCH, *see pp. 60-61*
Also see the Vac-U-Chamber on pp. 62-63.

ABOUT

FlexFoil PLUS Sample Bag

Applications

- Biogas and landfill gas (LFG) sampling
- VOCs
- Pollution level monitoring
- Site sampling/mobile surveys
- Breath analysis
- Calibration gas transfer
- Calibration mixtures
- Leak/spill exposure assessment



More Information

SKC Bag Stability Report –
www.skinc.com/instructions/1805.pdf
www.skinc.com

FlexFoil PLUS Bags with Single Polypropylene Fitting

Maximum Capacity (liter)	Cat. No.	Qty.	Fitting
1 <i>(Fits small Vac-U-Chamber Cat. No. 231-940)</i>	252-01 252-01A	10 ea	
3	252-03 252-03A	10 ea	
5	252-05	10	
8 <i>(Fits large Vac-U-Chamber Cat. No. 231-939)</i>	252-08	10	
10 <i>(Fits extra-large Vac-U-Chamber Cat. No. 231-944)</i>	252-10	10	
25 <i>(Fits jumbo Vac-U-Chamber Cat. No. 231-946)</i>	252-25	5	
50	252-50	5	
Replacement Septa	236-01-RS	10	

FlexFoil PLUS Bags with Single Stainless Steel Fitting

Maximum Capacity (liter)	Cat. No.	Qty.	Fitting
1	253-01 253-01A	10 ea	
3	253-03 253-03A	10 ea	
5	253-05	10	
10	253-10	10	
25	253-25	5	
50	253-50	5	
Replacement Septa	233-01-RS	10	

FlexFoil PLUS Bags with Breath-gas Analysis Fitting

Description	Cat. No.	Qty.	Fitting
FlexFoil PLUS Sample Bags, 1 liter , each with individually packaged clean mouthpiece <i>See About on p. 54 for details.</i>			
Stainless steel fitting	269-01	5	
Polypropylene fitting	269-01-PP	5	

ABOUT

Breath-gas Applications

- ACGIH BEIs for end-exhaled air
- Metabolic status determination
- Asthma detection by exhaled nitric oxide
- Lung cancer detection
- Diabetes detection
- Fructose malabsorption with hydrogen breath test
- Helicobacter pylori (H. pylori) with urea breath test
- Organ rejection detection
- Carbon monoxide poisoning detection
- Smoking cessation evaluation



Easy sampling for breath-gas analysis

Tech Tips

- ▶ SamplePro FlexFilm bags have a maximum operating temperature of 60 C (140 F).
- ▶ Store bags flat. Rolling or creasing bags during storage can affect performance.
- ▶ Inflate bags only to 80%.

SamplePro FlexFilm as Alternative to Tedlar

SKC SamplePro FlexFilm bags are a suitable low-cost alternative to Tedlar.

- Tests on 14 compounds in FlexFilm provided recoveries of > 80% after two days of ambient storage; results for the same compounds were similar in Tedlar.
- A side-by-side background study of Tedlar and FlexFilm proved FlexFilm has three times lower VOC background than Tedlar.
- FlexFilm exhibits higher levels of hydrogen sulfide and carbonyl sulfide background than Tedlar.
- FlexFilm requires flat storage to maintain material integrity.



More Information

SKC Bag Stability Report –
www.skcinc.com/instructions/1805.pdf

www.skcinc.com

SamplePro FlexFilm Air Sample Bags Economical Alternative to Tedlar for VOCs

- ▶ Best alternative to Tedlar for performance and economy
- ▶ Lower total VOC background than Tedlar
- ▶ Minimal adsorption
- ▶ Choice of fittings
 - Single combined polypropylene hose/valve and septum for economy and light weight
 - Dual stainless steel for sampling flexibility
- ▶ Stocked in a variety of sizes; custom bags available

Performance Profile

Background

Low VOC (lower total VOCs than Tedlar)

Stability

Good for VOCs, CO, CO₂, methane, and SF₆
 Acceptable for some sulfur compounds

Thickness

3 mil

Sample Pump

Grab Air or Pocket Pump TOUCH, see pp. 60-61
 Also see the Vac-U-Chamber on pp. 62-63.

FlexFilm Bags with Single Polypropylene Fitting

Maximum Capacity (liter)	Cat. No.	Qty.	Fitting
0.5	236-006 236-006A	10 ea	
1 <i>(Fits small Vac-U-Chamber Cat. No. 231-940)</i>	236-001 236-001A	10 ea	
3	236-002 236-002A	10 ea	
5	236-005 236-005A	10 ea	
8 <i>(Fits large Vac-U-Chamber Cat. No. 231-939)</i>	236-004	10	
10 <i>(Fits extra-large Vac-U-Chamber Cat. No. 231-944)</i>	236-003 236-003A	10 ea	
25 <i>(Fits jumbo Vac-U-Chamber Cat. No. 231-946)</i>	236-007	5	
40	236-040	5	
80	236-080	5	
Replacement Septa	236-01-RS	10	

FlexFilm Bags with Dual Stainless Steel Fittings

Maximum Capacity (liter)	Cat. No.	Qty.	Fitting
0.5	237-02 237-02A	10 ea	
1	237-01 237-01A	10 ea	
3	237-03 237-03A	10 ea	
5	237-05 237-05A	10 ea	
10	237-08 237-08A	10 ea	
25	237-25	5	
40	237-40	5	
80	237-80	5	
Replacement Septa	231-9-04	10	

Larger FlexFilm bag sizes are available. Contact SKC.

SKC CUSTOM AIR SAMPLE BAGS SAMPLE BAGS MADE YOUR WAY!

Special bag sizes

SKC manufactures single or multiple-cell sample bags for your applications.

Quality fittings for your applications

SKC offers fittings designed specifically for air sampling in the following configurations and materials:

- ⊙ All-in-one Stainless Steel
- ⊙ Dual Stainless Steel
- ⊙ All-in-one Polypropylene
- ⊙ All-in-one PTFE
- ⊙ Combination

Choice of bag material

SKC manufactures its bags from ultra-clean top-grade materials with strong evenly sealed seams. Choose from the following bag materials:

- ⊙ SamplePro FlexFilm (3 mil)
- ⊙ Tedlar (2 mil)
- ⊙ 4-ply Standard FlexFoil (5 mil)
- ⊙ 4-ply FlexFoil PLUS (5 mil)

SKC will create the bags you need!

Select the film, fitting, and bag dimensions at www.skcinc.com/catalog/infopage.php?id=2900 and send the form to your SKC representative. SKC will take it from there!



Indoor air



Biogas/landfill
gas/Superfund sites



Soil vapor



Stack emissions



Worker or
process exposure



Material testing

SKC custom sample bags are proven performers!

Contact SKC today for a quote on your custom sample bags!
www.skcinc.com and search on "laboratories"

Grab Air Sample Pump – 1 L/min Economy Pump for Filling Bags

- ▶ 9-volt alkaline battery for approximately 1000 liters of volume on one battery
- ▶ Low battery indicator
- ▶ Fixed 1 L/min flow rate

The SKC Grab Air Sample Pump is an economical choice for grab-and-go bag sampling when intrinsic safety is not required. Grab Air operates at a fixed flow rate of 1 L/min for up to 1000 liters of volume on one 9-volt battery. Simply attach a sample bag to the outlet port and turn on the pump. Simple, quick, economical — Grab Air.



Description	Cat. No.
Grab Air Pump with 9-volt alkaline battery; for tubing, see Cat. No. 231-9-23 below	222-2301
Grab Air Hazmat Kit includes pump as described above, 0.9 meter (3 feet) of 4.76-mm (3/16-inch) ID PTFE tubing, and ten 1-liter Tedlar bags with single polypropylene fitting Cat. No. 232-01	222-2111

PTFE Tubing Inert Tubing for Bag Sampling

- ▶ Heat and corrosion resistant
- ▶ Chemically inert
- ▶ Strong

Chemically inert SKC PTFE tubing is ideal for bag sampling to prevent sample loss through adsorption to the tubing's inner surface. SKC offers PTFE tubing with different diameters to fit over or inside bag fittings.



PTFE Tubing	Cat. No.	Length in Meters (feet)
Fits over all SKC bag fittings and Grab Air pump exhaust 4.76-mm (3/16-inch) ID, 6.35-mm (1/4-inch) OD	231-9-23	3 (10)
Fits inside bag fitting 1.59-mm (1/16-inch) ID, 3.18-mm (1/8-inch) OD	231-9-21	3 (10)
Fits Vac-U-Chamber sample inlet port 6.35-mm (1/4-inch) ID, 7.94-mm (5/16-inch) OD	231-937 231-924	3 (10) 15 (50)

Tech Tips

▶ Use only PTFE tubing for bag sampling to prevent sample loss through adsorption to the tubing's inner surface.

▶ PTFE tubing can be used at temperatures up to 260 C (500 F).

Pocket Pump[®] TOUCH – 20 to 500 ml/min **Programmable Pump for Bag Sampling**

- 20-hour run time with rechargeable Li-Ion battery
- Constant flows from 20 to 500 ml/min — also suitable for sorbent tube sampling and other low flow applications
- Simple operation for quick grab samples
- Program with a PC and DataTrac Pro Software for delayed start and timed runs for studies
- Continuous sample volume calculations
- Quick-connect adapter accessory makes bag sampling easy (see below)



Certifications	
CE	UL US LISTED

Description	Cat. No.
Pocket Pump TOUCH with Li-Ion battery pack Requires Pocket Pump TOUCH charger Cat. No. 220-300 and adapter Cat. No. 220-200 for bag sampling; see below	220-1000TC
Pocket Pump TOUCH Single Charger	220-300



For negative pressure sample collection
 see pages 62-63

Quick-connect Accessory for Secure Bag Sampling

- Rugged metal
- Easy installation
- Holds 6.35-mm (1/4-inch) OD tubing securely
- Press to release tubing



Only for
 Pocket Pump
 TOUCH

The Quick-connect Adapter accessory makes bag sampling with Pocket Pump TOUCH fast and easy. The Quick-connect Adapter threads into the pump exhaust port and securely holds 6.35-mm (1/4-inch) OD tubing (Cat. No. 231-9-23) during sampling. When sampling is complete, a quick press of the adapter flange releases the tubing.

Cat. No.220-200

Vac-U-Chamber

Eliminates Pump Contamination During Bag Sampling

- ▶ **Allows direct filling of air sample bags**
 - Uses negative pressure provided by most personal air sample pumps
 - Designed to contain SKC sample bags
- ▶ **Rugged and airtight construction**
 - Will not collapse under vacuum
- ▶ **Available in several sizes, including extra large for EPA Method 0040**
- ▶ **Protects sample and pump from contamination**
 - Sample does not pass through the pump
 - Sample contacts only inert tubing and bag
- ▶ **Sample line extends from contaminant source through case to bag**



For Convenient, Reliable Bag Sampling

The SKC Vac-U-Chamber is a rigid air sample box that allows sample bags to be filled directly by using negative pressure provided by most personal air sample pumps. Because the sample does not pass through the pump, both sample and pump contamination are eliminated. All surfaces in contact with the sample are constructed of inert materials. The Vac-U-Chamber's rigid walls will not collapse under vacuum conditions.

Vapor Intrusion Monitoring

Soil Gas Sampling for Vapor Intrusion Evaluations

Soil gas sampling can identify underground contamination and trace the source, extent, and movement of pollutants.

U.S. EPA Standard Operating Procedure (SOP) 2042 for Soil Gas Sampling specifies sample bags as containers inside an airtight chamber (e.g., Vac-U-Chamber). A sample pump creates negative pressure in the chamber, causing soil gas to enter into the bag directly. Samples are analyzed in the field with direct-reading instruments and/or in a qualified laboratory.

Vac-U-Chamber

Multiple Sizes Available for Your Applications

Applications

- U.S. EPA Method 18 (VOCs — industrial sources)
- U.S. EPA 0040 (POHCs — stationary sources)
- Soil gas/vapor sampling
- U.S. EPA SOP 2042
- Indoor air remediation system monitoring petroleum constituents (U.S. EPA SOPs 2102, 2103, and 2104)
- Groundwater testing
- Stack sampling
- Ventilation studies
- Hazmat testing



Standard of Good Practice

For best results, do not reuse sample bags. This prevents the risk of “carry over” from the previous sample.

Reference: McGarvey, L.J., Shorten, C.V., “The Effects of Adsorption on the Reusability of Tedlar Air Sample Bags,” AIHA Journal, Vol. 61, May/June 2000, pp. 375-380.

Small Vac-U-Chamber for 1-liter Bags

Description	Cat. No.	Qty.	
Complete Vac-U-Chamber Kit includes Standard AirChek XR5000 sample pump, single charger, small Vac-U-Chamber, and 10 Tedlar sample bags Cat. No. 232-01 100-240 V	210-4124	ea	
Small Vac-U-Chamber only with polypropylene fittings (supplied without pump), suitable for use with SKC 1-liter sample bags below	231-940	ea	
1-liter Sample Bags with single polypropylene fitting, for use with small Vac-U-Chamber Cat. No. 231-940	Tedlar	232-01	10
	SamplePro FlexFilm	236-001	10
	FlexFoil PLUS	252-01	10
	Standard FlexFoil	262-01	10

Large Vac-U-Chamber for 8-liter Bags

Description	Cat. No.	Qty.	
Complete Vac-U-Chamber Kit includes Standard AirChek XR5000 sample pump, single charger, large Vac-U-Chamber, and 10 Tedlar sample bags Cat. No. 232-939 100-240 V	210-4115	ea	
Large Vac-U-Chamber only with stainless steel fittings (supplied without pump), suitable for use with SKC 8-liter sample bags below	231-939	ea	
8-liter Sample Bags with single polypropylene fitting, for use with large Vac-U-Chamber Cat. No. 231-939	Tedlar	232-939	10
	SamplePro FlexFilm	236-004	10
	FlexFoil PLUS	252-08	10
	Standard FlexFoil	262-08	10

Extra-large Vac-U-Chamber for 10-liter Bags

Description	Cat. No.	Qty.	
Extra-large Vac-U-Chamber only with stainless steel fittings (supplied without pump), suitable for use with SKC 10-liter sample bags below	231-944	ea	
10-liter Sample Bags with single polypropylene fitting, for use with extra-large Vac-U-Chamber Cat. No. 231-944	Tedlar	232-10	10
	SamplePro FlexFilm	236-003	10
	FlexFoil PLUS	252-10	10
	Standard FlexFoil	262-10	10

Jumbo Vac-U-Chamber for 25-liter Bags

Description	Cat. No.	Qty.	
Jumbo Vac-U-Chamber only with stainless steel fittings (supplied without pump), suitable for use with SKC 25-liter sample bags below	231-946	ea	
25-liter Sample Bags with single polypropylene fitting, for use with jumbo Vac-U-Chamber Cat. No. 231-946	Tedlar	232-25	5
	SamplePro FlexFilm	236-007	5
	FlexFoil PLUS	252-25	5
	Standard FlexFoil	262-25	5



*For Sample Pumps,
see pages 14-15*



More Information

www.skcinc.com

Search “1665”



ABOUT

Certificates of Conformance

SKC provides online Certificates of Conformance for SKC-manufactured coated filters. Visit www.skcinc.com and search "conformance" to view certificates.

ABOUT

OSHA NEP for Isocyanates

In 2013, OSHA announced a three-year National Emphasis Program (NEP) to protect workers from the serious health effects of occupational exposure to isocyanates. Workers are most commonly exposed to these highly reactive, low molecular weight chemicals while manufacturing foams, fibers, coatings, and elastomers. Isocyanate exposure can cause occupational asthma, pneumonitis, irritation of the skin and mucous membranes, cancer, and death. Respiratory illnesses also can be caused by isocyanate exposure to the skin. Visit www.osha.gov/OshDoc/Directive_pdf/CPL_03-00-017.pdf for more information.

SKC Chemically Coated Filters

Convenient Alternative to Impinger Wet Chemistry Methods

- ▶ Meet agency method specifications
- ▶ Economical
- ▶ Ready to use
 - Preloaded into cassettes with end plugs and shrink bands
- ▶ Time-saving
- ▶ Easy personal sampling
- ▶ Small package sizes for short shelf-life products
- ▶ Custom coated filters are available

SKC Coated Filters make sampling reactive compounds fast, easy, and safe. Simply unplug the lightweight cassette, insert it into an SKC Filter Cassette Holder, clip to a worker's collar, and attach the cassette to a personal sample pump. There is no broken glass or splashing reagent. In addition, most filter coatings derivatize the contaminant(s) of interest, producing a more stable compound for storage and analysis. Use SKC Coated Filters to collect compounds that exist as an aerosol or mist or for some higher boiling vapors.



Sample Time:	Varies; 15 minutes to 1 hour
Sample Rate:	0.5 to 5 L/min
Sample Pump:	AirChek Series
Analysis:	Typically solvent extraction and gas or liquid chromatography

Custom Coated Filters

Made to Your Specifications

Choose from quality filter materials

- Glass fiber
- Mixed cellulose ester (MCE)
- Polyvinyl chloride (PVC)
- PTFE
- Other materials available

Specify filter pore size and diameter

Choose from a variety of support materials

Strict QC ensures consistent, accurate loading of specified coating

Supplied as filters only or preloaded in cassettes for ready use

- Preloaded cassettes are available with shrink bands

Contact your SKC representative today or visit www.skcinc.com/catalog/infopage.php?id=2900.



Chemically Coated Filter Selection Guide

Chemical	Method [∞]	Preloaded Filter; Coating (in 37-mm cassettes)	Cat. No.*	Qty.
Acetic anhydride	OSHA 82	2 Glass filters; 1-(2-pyridyl) piperazine §	225-9009 §	10
Acetic anhydride	OSHA 102	2 Glass filters; veratrylamine and di-n-octyl phthalate	225-9010 †	10
4-Aminobiphenyl	OSHA 93	2 Glass filters; sulfuric acid	225-9004	10
Aniline	NIOSH 2017 ‡	2 Glass filters; sulfuric acid	225-9004 ‡	10
Arsenic, volatile compounds	OSHA ID-105	1 MCE filter and cellulose pad; sodium carbonate	225-9001	10
Benzidine	OSHA 65	2 Glass filters; sulfuric acid	225-9004	10
Bromine, chlorine	NIOSH 6011	1 25-mm PTFE pre-filter and polypropylene support; 1 25-mm specially cleaned silver membrane and polypropylene support (in 25-mm cassette)	225-9006	5
Crotonaldehyde	OSHA 81	2 Glass filters; 2,4-dinitrophenylhydrazine and phosphoric acids §	225-9019 §	10
o-Dianisidine	OSHA 71	2 Glass filters; sulfuric acid	225-9004	10
3,3'-Dichlorobenzidine	OSHA 65	2 Glass filters; sulfuric acid	225-9004	10
Diisocyanates (HDI; 2,6-TDI; 2,4-TDI)	ASTM D5836 Δ OSHA 42 ‡	1 Glass filter and cellulose support; 1-(2-pyridyl)piperazine ‡§	225-9013 ‡† 225-9002 ‡§	10 10
Diphenylamine	OSHA 78	2 Glass filters; sulfuric acid	225-9004	10
Fluorides	OSHA ID-110 NIOSH 7902 ASTM D4765	1 MCE filter and cellulose pad; sodium carbonate	225-9001 #	10
Fluorides, particulate	NIOSH 7906	2 Nitrocellulose filters; 1 coated with sodium carbonate, 1 uncoated	225-9031	10
Glutaraldehyde	OSHA 64	2 Glass filters; 2,4-dinitrophenylhydrazine and phosphoric acid §	225-9003 §	10
Hydrazine	OSHA 108	2 Glass filters; sulfuric acid	225-9012	10
Hydrofluoric acid	NIOSH 7906	2 Nitrocellulose filters; 1 coated with sodium carbonate, 1 uncoated	225-9031	10
Hydrogen bromide	NIOSH 7907	2 Quartz filters; 1 coated with sodium carbonate, 1 uncoated	225-9032	10
Hydrogen chloride	NIOSH 7907	2 Quartz filters; 1 coated with sodium carbonate, 1 uncoated	225-9032	10
Hydrogen peroxide	OSHA 1019 NON 57 •	2 25-mm Quartz filters; titanium oxysulfate hydrate (in 25-mm cassette)	225-9030 •	10
Isocyanates	ASTM Σ	1 PTFE filter; 1 glass filter impregnated with MAMA (ISO-CHEK Sampling System, see p. 66)	225-9022 Σ 225-9022A Σ	12 36
Isocyanates (HDI; 2,6-TDI; 2,4-TDI)	ASTM D5836 Δ OSHA 42 ‡	1 Glass filter and cellulose support; 1-(2-pyridyl)piperazine ‡§	225-9013 ‡† 225-9002 ‡§	10 10
Isocyanates (HDI, MDI, TDI, IPDI, HDI-BT, HDI-IC)	OR-OSHA 1010 ▼	1 13-mm Glass filter; MAMA (in 13-mm Swinnex holder) §	225-9029 §▼	5
Isocyanates, organic	MDHS 25/3 (U.K.)	1 25-mm A/E glass filter; methoxyphenyl piperazine ◊§	Special order	5
n-Isopropylaniline	OSHA 78	2 Glass filters; sulfuric acid	225-9004	10
Maleic anhydride	OSHA 86	2 Glass filters; veratrylamine §	225-9021 §	10
Maleic anhydride	■	1 25-mm Glass filter; veratrylamine ◊§	225-9028 ◊§	10
Mercaptans (methyl-, ethyl-, n-butyl-, phenyl-)	NIOSH 2542 OSHA 26	1 Glass filter; mercuric acetate §	225-9007 §	10
4,4'-Methylene bis (2-chloroaniline) (MOCA)	OSHA 71	2 Glass filters; sulfuric acid	225-9004	10
Methylene bisphenyl (MDI)	OSHA 47 ‡	1 Glass filter and cellulose support; 1-(2-pyridyl)piperazine ‡§	225-9013 ‡† 225-9002 ‡§	10 10
4,4'-Methylenedianiline	OSHA 57 Ω NIOSH 5029	2 Glass filters; sulfuric acid	225-9004	10
1-Naphthylamine, 2-naphthylamine	OSHA 93	2 Glass filters; sulfuric acid	225-9004	10
Nitric acid	NIOSH 7907	2 Quartz filters; 1 coated with sodium carbonate, 1 uncoated	225-9032	10
Nitrobenzene	NIOSH 2017 ‡	2 Glass filters; sulfuric acid	225-9004 ‡	10
Ozone	OSHA ID-214	2 Glass filters; nitrite-impregnated §	225-9014 §	10
Phenylenediamine (o-, m-, p-)	OSHA 87	2 Glass filters; sulfuric acid	225-9004	10
Phosphine	OSHA 1003	1 Glass filter; 1 polyester filter coated with mercuric chloride §	225-9018 ‡§	10
Phosphoric acid	NIOSH 7908	1 Quartz filter ▲	225-9033	10
Sulfur dioxide	NIOSH 6004 (modified)	1 MCE pre-filter and support/1 cellulose filter and support; sodium carbonate	225-9005	10
Sulfuric acid	NIOSH 7908	1 Quartz filter ▲	225-9033	10
2,4-Toluenediamine	OSHA 65	2 Glass filters; sulfuric acid	225-9004	10
2,6-Toluenediamine	OSHA 65	2 Glass filters; sulfuric acid	225-9004	10
o-Tolidine	OSHA 71	2 Glass filters; sulfuric acid	225-9004	10
o-Toluidine	NIOSH 2017 ‡	2 Glass filters; sulfuric acid	225-9004 ‡	10
Toluidine (o-, m-, p-)	OSHA 73	2 Glass filters; sulfuric acid	225-9004	10
1,3,5-Triglycidyl isocyanurate (TGI)	OSHA PV2055	1 Glass filter; hydrobromic acid	225-9027	10
Valeraldehyde	OSHA 85	3 Glass filters; 2,4-dinitrophenylhydrazine and phosphoric acid §	225-9020 §	10
m-Xylenediamine (m-XDA, p-XDA)	OSHA 105	2 Glass filters; sulfuric acid	225-9004	10

* Coated filters have a limited shelf-life.

† Custom order due to very limited shelf-life

Δ ASTM D5836 and D5932 for 2,4-TDI, 2,6-TDI only

◊ Filters only; not preloaded in cassettes

§ Storage below 4 C (39.2 F) required

‡ Also requires Sorbent Tube Cat. No. 226-15, see page 38

Ω OSHA 57 is an update of NIOSH 5029, which called for a single filter.

‡ See Tech Tips on page 98.

Σ Meets multiple ASTM methods, see page 66

Collects both vapor and aerosol phases of fluorides. Patented in Canada by IRSST (Institut de recherche Robert-Sauvé en santé et en sécurité du travail du Québec), Canada Patent No. 1,299,114

∞ The methods listed are the most widely used. Additional methods may be listed in the Sampling Guide. See pages 143-211.

• Also requires Sorbent Tube Cat. No. 226-193-UC or 226-199-UC for simultaneous, separate sampling of paracetamol, see page 42

▼ Also requires Impinger Cat. No. 225-36-1, see page 67

■ For inhalable TLV; analysis by OSHA 86

▲ A coated filter is not needed for this method as sulfuric acid and phosphoric acid are non-volatile acids and are present in the air as an aerosol.

the ISO-CHEK Advantage!

- ✓ **Simultaneous collection and separation of phases at the point of collection**
Less time-consuming and more accurate analysis of each phase
- ✓ **Reagent is stable at room temperature.**
- ✓ **1 L/min flow efficiently captures aerosol phase isocyanates compared to denuder collectors.**
- ✓ **No handling precautions**
No broken glass or splashing impinger liquid

Standard of Good Practice

Store and prepare sampling media in solvent-free environments.

ABOUT

ISO-CHEK Development

ISO-CHEK was developed and patented by IRSST (Institut de recherche Robert-Sauvé en santé et en sécurité du travail du Québec).



More Information

www.skcinc.com

Search "1869"

ISO-CHEK

Simultaneous and Separate Collection of Isocyanate Phases

- ▶ **Accurately samples diisocyanates: HDI, MDI, IPDI, HMDI, 2,4-TDI, and 2,6-TDI**
- ▶ **Meets the specifications of several methods**
 - ASTM D5932 for 2,4 and 2,6-TDI
 - ASTM D6561 for HDI
 - ASTM D6562 for HDI
- ▶ **The only filter-based system that simultaneously traps and separates both monomers and oligomers**
 - For better determinations of control strategies
- ▶ **Decreases sample preparation and analysis time by 40% compared to other methods**
 - Premade calibration standards are available
- ▶ **Highly stable — low temperature storage and transport not required**
- ▶ **Highly sensitive analysis provides detection limits below current regulated exposure levels**
 - Ideal for occupational sampling and environmental surveys
 - Requires only a 15-minute sample time
- ▶ **Round-robin proficiency testing for ISO-CHEK labs ensures accurate, consistent analysis**
 - See laboratory list at www.skcinc.com

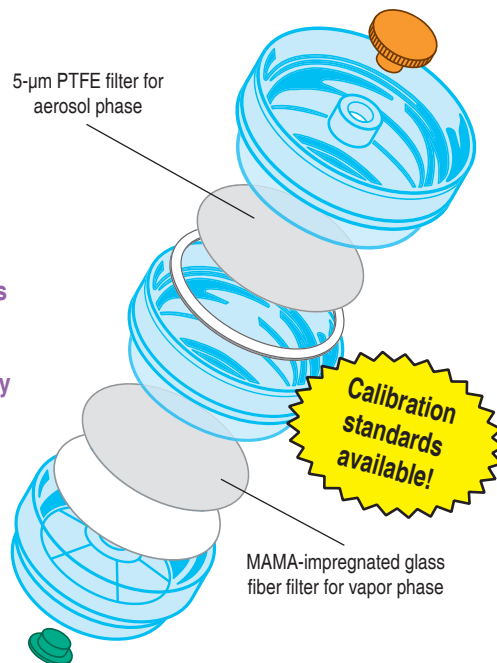

Exploded view of ISO-CHEK Filter Cassette (Cassette in image is tinted for clarification.)

Suitable for most isocyanates, the patented[#] ISO-CHEK[®] Sampling System employs a two-stage filter arrangement that results in the simultaneous collection and separation of vapor from aerosol at the point of collection. The filter that collects the vapor phase is impregnated with 9-(N-methyl-aminomethyl) anthracene (MAMA), a highly stable reagent that minimizes storage and handling requirements.

Description	Cat. No.	Qty.
ISO-CHEK Sampling System with Derivatizing Reagent ,** preloaded clear cassettes and jars of Derivatizing Solution (MOPIP in toluene)	225-9023	4
	225-9023A	10
ISO-CHEK Cassettes ,* preloaded clear cassettes for isocyanates, requires Derivatizing Solution; see below	225-9022	12
	225-9022A	36

Accessories	Cat. No.	Qty.
Derivatizing Solution ,** 5 ml of MOPIP in toluene, in jars	225-9050	12
Jars , 37 mm with PTFE-lined cap	225-8377	36
Calibration Standard , [‡] MAMA-HDI, 1 gram	225-9053	ea
Calibration Standard , [‡] MAMA-HMDI, 1 gram	225-9056	ea
Calibration Standard , [‡] MAMA-IPDI, 1 gram	225-9054	ea
Calibration Standard , [‡] MAMA-MDI, 1 gram	225-9062	ea
Calibration Standard , [‡] MAMA-2,4-TDI and 2,6-TDI, 1 gram	225-9052	ea
Calibration Standard Set , [‡] HDI, MDI, IPDI, 2,4-TDI, 2,6-TDI, 1 gram each	225-9055	set
Packaging Kit , materials for shipping 10 packages of 10 samplers and jars	225-9059	ea

[#] U.S. Patent No. 4,961,916; see About at left

* Limited shelf-life

[†] Hazmat shipping charges for air shipments only, ground shipments exempt

[‡] Limited shelf-life, freezer storage recommended; refrigerated shipping not required

Glass Midget Impingers

Collection of Airborne Hazards into Liquids

SKC glass impingers feature graduations that are accurate to within ± 0.5 ml for each increment. Serial numbers on both sections assist with sample identification and proper part matching.

Standard Midget Impinger has a 25-ml capacity with graduations in 5-ml increments. The nozzle is precisely placed to ensure proper collection.

Special Midget Impinger with Fritted Nozzle is a modified standard midget impinger with a special fritted nozzle to increase contact between the air sample and the liquid. Many NIOSH and OSHA procedures call for this type of bubbler impinger.

Spill-resistant Midget Impinger features a special outlet side arm that extends midway down with sufficient capacity above to handle all liquid in the standard or fritted impinger.

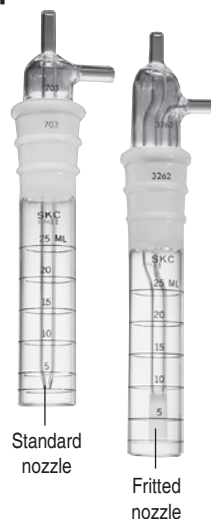

Tech Tips

► Use a trap with impingers to prevent impinger liquid from being drawn into the sample pump. Solid sorbents may be added to the trap when using a volatile liquid to protect the pump chamber from vapors. See Cat. Nos. 225-22 and 225-22-01.



Glass Trap shown with Impinger and PCXR8 Sample Pump

Glass Midget Impinger	Cat. No.
Standard Midget, 25 ml, standard nozzle	225-36-1
Special Midget, 25 ml, fritted nozzle, 170 to 220-micron frit	225-36-2
Spill-resistant Midget, 25 ml, standard nozzle	225-36-4
Spill-resistant Midget, 25 ml, fritted nozzle, 170 to 220-micron frit	225-36-5
Glass Midget Impinger Accessories	
Trap for Midget Impingers, glass trap for area sampling, can be used with or without sorbent, see photo at right	225-22
In-line Plastic Traps with sorbent to remove vapors, pk/3	225-22-01
Replacement Trap Sorbent, 200 grams, to remove vapors, for use in Cat. Nos. 225-22 and 225-22-01	225-22-02
Holster, thick vinyl fabric with a clip for attachment to clothing	225-20*
Holder,* for attaching to air sample pump	
Single,* stainless steel, for 1 impinger or 1 trap	225-20-01
Double,* stainless steel, for 2 impingers or impinger and trap	225-20-02

* Not suitable for PFA impingers

PFA Midget Impingers

Savillex PFA (fluoropolymer) 60-ml impingers are unbreakable, inert to virtually all chemicals, and perform well in high-temperature and cryogenic applications. Available in two different port configurations, the transfer caps and ferrule nuts provide a leak-tight seal.

PFA Midget Impinger	Cat. No.
Impinger with 1-piece Molded Transfer Cap, 60-ml capacity, with a 6.35-mm ($\frac{1}{4}$ -inch) vertical port and a 6.35-mm ($\frac{1}{4}$ -inch) side port for horizontal connections; includes ferrule nuts	225-0020
Impinger with Port Transfer Cap, 60-ml capacity, with 2 vertical 6.35-mm ($\frac{1}{4}$ -inch) ports for close assembly of sampling train; includes ferrule nuts	225-0021
PFA Midget Impinger Accessories	
Single Holder for PFA Impinger, [†] stainless steel, attaches to sample pump	225-0026
Holster for PFA Impinger, [†] vinyl, with clip, for attaching to clothing	225-0027
In-line Plastic Traps with sorbent to remove vapors, pk/3	225-22-01
Replacement Trap Sorbent, 200 grams, to remove vapors, for use in Cat. Nos. 225-22 and 225-22-01	225-22-02
180-degree PFA Tube Bend, 6.35-mm diameter x 203.2-mm length ($\frac{1}{4}$ -inch diameter x 8-inch length), used to connect 2 PFA impingers, for use with Cat. No. 225-0021 only	225-0022
90-degree PFA Tube Bend, 6.35-mm diameter x 152.4-mm length ($\frac{1}{4}$ -inch diameter x 6-inch length), used to connect 2 PFA impingers, for use with Cat. No. 225-0021 only	225-0023

[†] Not suitable for glass impingers

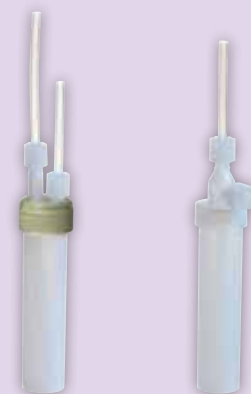

Cat. No. 225-0021 Cat. No. 225-0020

SKC Passive Samplers

New Designs for New Applications

SKC sorbent innovation and research is not limited to sorbent tubes. SKC has carefully designed passive samplers filled with SKC quality sorbents to provide accurate, reliable, and convenient alternatives to active sampling for many compounds. SKC Passive Samplers are specified in OSHA diffusive methods.

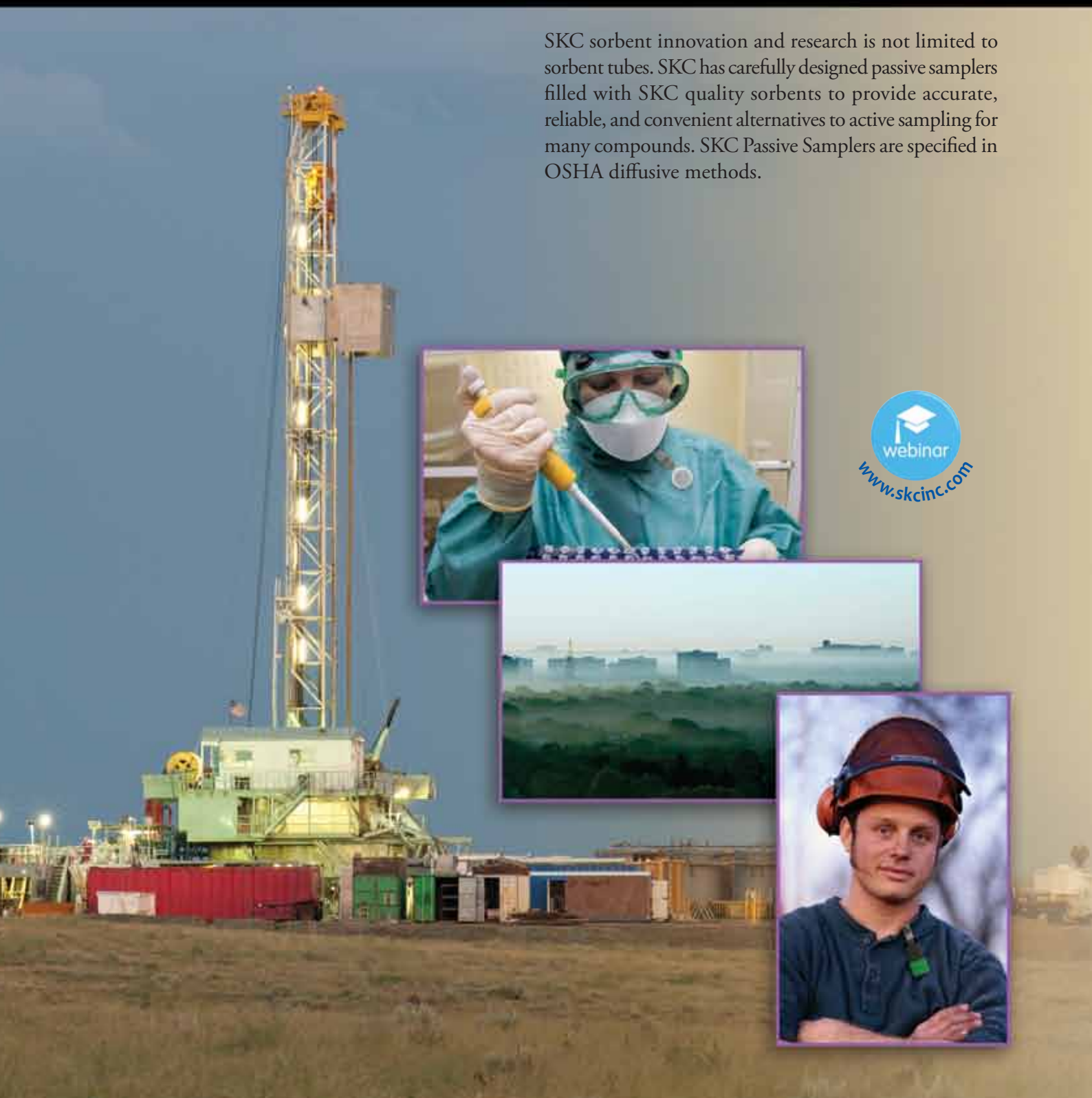



Diffusive TD Tubes

BTEX/Other VOCs

See pages 70-71



VOC Chek 575 and ULTRA

ppb to ppm-Level VOCs

See pages 74-75 and 72-73



Passive Samplers for Health Care

Ethylene Oxide, Isoflurane, Halothane

See page 83



UMEX 100

Formaldehyde/Other Aldehydes

See page 84



UMEX 200

Nitrogen Dioxide/Sulfur Dioxide

See page 85



UMEX 300

Ammonia

See page 85

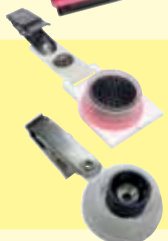

Elemental Mercury and Hydrogen Cyanide

See page 86

Diffusive TD Tubes

BTEX/Other VOCs

Diffusive Thermal Desorption Tubes Time-averaged Assessment of BTEX and Other VOCs

- ▶ Validated sampling rates for benzene, toluene, ethylbenzene, xylenes, and many other VOCs
- ▶ Contain pre-conditioned Carboxpack® X sorbent
- ▶ SilcoNert® 2000 deactivated 3.5 x 0.25-inch OD stainless steel tubes
 - Ideal for protecting sample integrity over long sampling periods
- ▶ Use to determine average concentration over longer sampling periods up to 14 days
- ▶ No pump or training required
- ▶ Reusable to keep costs low
- ▶ Unique identification number and bar code
- ▶ Weatherproof tube shelter available
- ▶ Airflow and cap placement arrow indicators printed on tube
- ▶ Sealed with brass Swagelok screw caps with PTFE ferrules for transport
- ▶ Each collected compound can be analyzed quantitatively

SKC Diffusive Thermal Desorption (TD) Tubes are designed to provide accurate sampling of VOCs at refinery fencelines and for other ambient air monitoring applications without the use of a sample pump. Sampling times of up to 14 days provide an average concentration that eliminates the effects of daily variables such as hazard concentration and temperature. A weatherproof shelter accessory protects samples.



Description	Cat. No.	Qty.
SKC Diffusive TD Tubes, * 3.5 x 0.25-in OD deactivated stainless steel tubes filled with pre-conditioned Carboxpack X and supplied with diffusion caps and brass Swagelok screw caps with PTFE ferrules	226-520	10
Diffusion Caps	226-525	10
Shelter	226-526	ea

* Tubes must be used within 30 days of conditioning

SKC Diffusive Thermal Desorption Tubes for BTEX and Other VOCs

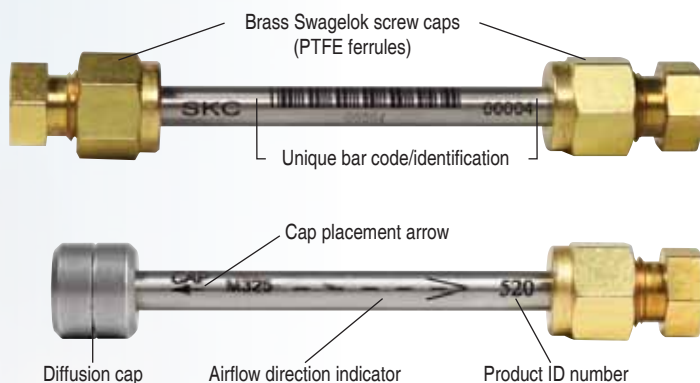

SKC Diffusive TD Tubes are conditioned and quality control tested to assure low background.



Weatherproof shelter accessory protects TD tubes.



More Information

McClenny, W.A. et al., "24 h Diffusive Sampling of Toxic VOCs in Air onto Carbopack X ..." <http://doi.org/fhgn4s>

U.S. EPA Method 325B: <https://goo.gl/B4viuV>

www.skcinc.com

ULTRA Passive Samplers

Convenient Alternative to Canisters and Thermal Desorption Tubes

Compare ULTRA to Canisters

Side-by-side studies using ULTRA® Passive Samplers (Anasorb GCB1) and stainless steel canisters demonstrate excellent sampling correlation.

Compound	ULTRA (µg/m³)	Canister (µg/m³)
Benzene	4.2	4.5
	2.1	2.0
	1.9	1.6
	6.67	6.8
	1.58	1.5

Compound	ULTRA (µg/m³)	Canister (µg/m³)
Perchloroethylene	1.1	1.6
	2.3	2.2
	32.9	30.0
	1.37	2.0
	2.85	2.6

Compound	ULTRA (µg/m³)	Canister (µg/m³)
o-Xylene	7.55	7.9
	1.16	0.93
	1.96	1.9
	8.3	6.2
	13.3	11.0

Compound	ULTRA (µg/m³)	Canister (µg/m³)
Toluene	30.0	26.0
	20.3	19.0
	44.0	46.0
	10.8	8.8
	6.1	3.8

Compound	ULTRA (µg/m³)	Canister (µg/m³)
m,p-Xylene	21.2	19.2
	5.52	5.6
	34.1	36.7
	3.7	2.51
	5.7	5.1

- ▶ **Results comparable to canisters for EPA Method TO-15**
 - No cleaning or certification costs
 - Lower purchase price
 - No expensive shipping
- ▶ **Passive alternative for EPA TO-17 — no pump required**
- ▶ **Choose from 5 sorbents for indoor and ambient air sampling (including SVOCs)**
 - Anasorb GCB1
 - Tenax TA
 - Chromosorb 106
 - Carbopack X
 - Charcoal (solvent extraction)
- ▶ **Easy on/off sampling**
- ▶ **Small, lightweight, and easy to transport**
- ▶ **Validated sampling (uptake) rates**
 - See www.skcinc.com/catalog/passive-guide.php
- ▶ **Built-in blank/correction sorbent section available**
- ▶ **Sample integrity**
 - Manufactured in an ultra-clean environment
 - Extensive cleaning and QC procedures
 - Sonically welded housing
- ▶ **Long-term sampling up to 30 days reduces temporal variability (see www.skcinc.com/pdf/1812.pdf)**
- ▶ **Ideal for vapor intrusion sampling**
 - See EPA-OSWER technical guide at www.epa.gov, search “vapor intrusion”



ULTRA Passive Samplers

Convenient Alternative to Canisters and Thermal Desorption Tubes



Patented* ULTRA — Front view

Ordering



Select from prefilled samplers or separate sampler housing and sorbent vials.

Sorbent/Amount	Economy Prefilled Samplers, without built-in blank, pk/5 Cat. No.	Prefilled Samplers, with built-in blank, pk/5 Cat. No.	Sorbent Vials for User-filled Samplers, pk/2, require empty housing Cat. No. 690-200 Cat. No.
Anasorb GCB1, [#] 370 mg in each compartment or vial	690-101-NB	690-101	690-201
Chromosorb 106, ^{#†} 285 mg in each compartment or vial	690-103-NB	690-103	690-203
Tenax TA, [#] 253 mg in each compartment or vial	690-104-NB	690-104	690-204
Charcoal, [#] 500 mg in each compartment or vial (solvent extraction)	690-105-NB	690-105	690-205
Carbopack X, [#] 400 mg in each compartment or vial	690-106-NB	690-106	690-206
Empty Sampler Housing, for user-filled ULTRA, required			690-200

Limited shelf-life

‡ Comparable to Carbopack B

† Go to www.osha.gov and search "ULTRA" for additional information on sampling rates for Chromosorb 106.

Sampling Accessories	Cat. No.
Rate Reducer , 12 holes, lowers sampling rate for extended sampling time and higher concentrations 	690-300
Transfer Funnel , for filling sampler housing with sorbent from vials, for ULTRA only 	690-301
Stand for Indoor Sampling	690-302
Shelter for Outdoor Sampling 	690-303

Analysis Accessories	Cat. No.
Thermal Desorption Tube , Perkin Elmer, 6.35 x 88.9 mm (0.25 x 3.5 inches), includes screens and end caps	P226530
Analysis Transfer Funnel , facilitates transfer of sorbent from vial to 6.35-mm (0.25-inch) OD thermal desorption tube	590-264

* U.S. Patent No. 6,607,581

See www.skinc.com/catalog/passive-guide.php for sampling rates for over 50 compounds.

SKC 575 Series Passive Samplers are now...

VOC 575 Series

✓ Decrease sampling costs

- More sorbent/capacity + validation to 2x exposure level
 - = One sampler per 8-hour shift
 - = One analysis of a single layer
 - = Savings for you

✓ Increase convenience

- No assembly required for sampling
- New design for easier sorbent transfer during analysis
- Reference guides available for laboratories

✓ Increase reliability

- Sampling rates for over 300 compounds (*see pages 76-82*)
- Online research reports document performance for legal and compliance issues. Visit www.skcinc.com/reports.asp
- Specialty samplers available for ethylene oxide (EtO), styrene, and methanol
- Validated in OSHA methods

Easy 3-step Sampling!



Remove front cap.



Clip in worker's breathing zone to sample.

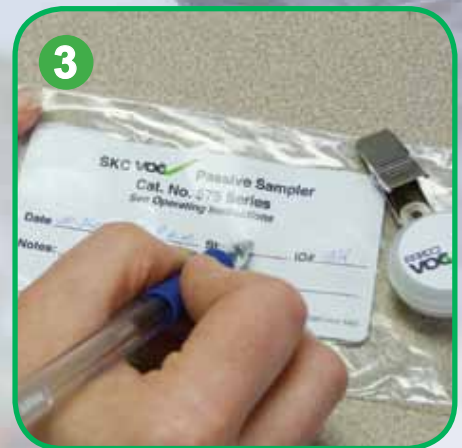

Cap and record information.

Passive Samplers

for ppm-Level Organic Vapors



Front of VOC Chek 575 Series Sampler
(actual size)

**New design –
easier analysis!**



Back of VOC Chek 575 Series Sampler
designed for easier analysis



Leader in Passive Sampler Technology

SKC VOC Chek® 575 Series Passive Samplers are identified as a reliable alternative to active sampling for many compounds in OSHA diffusive methods!

*Methanol
Passive Sampler
Cat. No. 575-007
see ordering below left*

Active/Passive Sampling Cross-reference

Compound	Active Method	Tube Cat. No.	Passive Method	Sampler Cat. No.
Benzene	OSHA 1005	226-01	OSHA 1005	575-002
Butyl acetates	OSHA 1009	226-01	OSHA 1009	575-002
MEK/MIBK	OSHA 16 (MEK)	226-10	OSHA 1004	575-002
Styrene	OSHA 89	226-73	OSHA 1014	575-006
Toluene	OSHA 111	226-81A or 226-01	OSHA 111	575-002
Trichloroethylene/ tetrachloroethylene	OSHA 1001	226-01	OSHA 1001	575-002
Xylenes/ethylbenzene	OSHA 1002	226-01	OSHA 1002	575-002

VOC Chek 575 Series Passive Sampler Ordering

Passive Sampler for:	Sorbent	Cat. No.
Organic vapors	Charcoal Lot 2000, 350 mg	pk/5 575-001†
		pk/25 575-001A
Organic vapors	Anasorb 747, 500 mg	pk/5 575-002†
		pk/25 575-002A
Ethylene oxide	Anasorb 747 treated with hydrobromic acid, 500 mg	pk/5 575-005
		pk/25 575-005A
Styrene	Anasorb 747 treated with tert-butyl catechol, 500 mg	pk/5 575-006
Methanol	Anasorb 747, 500 mg, includes secondary diffusion barrier	pk/5 575-007

† Larger quantity packages are available. Contact SKC.



**No need to double
your costs!**

VOC Chek Series samplers have:

- More sorbent in a single layer
- More capacity
- Validated results to 2x exposure limit
- Lower price than double-layer samplers

*See the VOC Chek
575 Series
Selection Guide
pages 76-82*

VOC Chek 575 Series Selection Guide On-worker ppm Level Sampling of Organic Vapors

SKC VOC Chek 575 Series Passive Samplers are available with sorbents such as activated carbon and Anasorb 747 that strongly retain the collected compounds and require solvent extraction for laboratory analysis.

Use the following guide to locate target compounds and get an overview of critical sampling parameters along with the SKC catalog number of the recommended SKC VOC Chek 575 Series Passive Sampler. Visit www.skinc.com and download our free SKC Sampling Guide app to access this information on your Android or Apple device.

Validation Levels

See the Validation Level column in this guide to determine the level of scientific testing. Go to www.skinc.com and search the number in the Research Report column to access online research reports.

Full – Stringent NIOSH testing protocol has been applied to verify sampler desorption efficiency, sampling rate, capacity, and the effects of relative humidity, temperature, concentration, reverse diffusion, and storage on accuracy.

Bi-level – NIOSH testing protocol has been applied to the most volatile member of a related (homologous) series of chemicals; therefore, related less volatile series members require only partial validation (*described below*) to achieve the same level of sampling accuracy. See *Guild et al.* (<http://doi.org/cjzqd7>) or request a copy from SKC.

Partial – NIOSH testing protocol has been applied to verify sampling rate, desorption efficiency, and storage stability.

Calculated – This calculation of a sampling or uptake rate uses the diffusion coefficient of a specific chemical (D) and the cross-sectional area (A) and length (L) of the sampler's diffusion path (based on sampler geometry).

OSHA – Sampler has been validated by OSHA and is referenced in a published OSHA method.

Chemical Hazard	Validation Level	Research Report	OSHA PELs Δ		Sampling Rate (ml/min)	Sampling Time		Analytical Method	DE %	SKC VOC Chek 575 Cat. No.
			TWA (ppm)	CLGSTEL (ppm)		Min (min)	Max (hrs)			
Acetic acid	Calculated		10	15 #	19.6			GC-FID	99.2	575-001
Acetic acid	Calculated		10	15 #	19.6			GC-FID	107.9	575-002
Acetoin (acetyl methyl carbinol)	Calculated				14.9			GC-FID		575-001 or 575-002
Acetone	Full	1303	1000		20.3 $\sqrt{}$	15	4	GC-FID	90.2	575-002
Acetone	Full	1303	1000		15.2 \approx	240	8 \approx	GC-FID	90.2	575-002
Acetonitrile	Calculated		40		22.4			GC-FID	103	575-001
Acetonitrile	Calculated		40		22.4			GC-FID	108	575-002
Acetyl methyl carbinol (acetoin)	Calculated				14.9			GC-FID		575-001 or 575-002
Acrylonitrile	Full		2	10 C	20.4	15	8	GC-FID	81	575-002
Allyl alcohol	Calculated		2	4 #	18.4			GC-FID	64	575-001
Allyl alcohol	Calculated		2	4 #	18.4			GC-FID	76	575-002
Allyl chloride	Calculated		1	2 #	17.8			GC-FID	95.1	575-001
Allyl chloride	Calculated		1	2 #	17.8			GC-FID	101.3	575-002
n-Amyl acetate	Calculated		100		11.7			GC-FID	93.5	575-001
n-Amyl acetate	Calculated		100		11.7			GC-FID	96	575-002
sec-Amyl acetate (2-pentyl acetate)	Calculated		125		11.8			GC-FID		575-001
n-Amyl alcohol	Calculated				13.9			GC-FID	87.3	575-001
n-Amyl alcohol	Calculated				13.9			GC-FID	100.6	575-002
t-Amyl methyl ether (methyl tert-amyl ether)	Bilevel	1355			13.1	30	8	GC-FID	99	575-001
Aniline	Calculated		5		14.2			GC-FID		575-001
Benzene	Full	1312	1	5	16	15	8	GC-FID	93.5	575-001
Benzene	OSHA 1005		1	5	17.1	15	8	GC-FID	93.6	575-002
Benzotrifluoride (trifluoromethyl benzene; OXSOL 2000)	Bilevel		100		13.3	15	8	GC-FID	106	575-001
Benzotrifluoride (trifluoromethyl benzene; OXSOL 2000)	Bilevel		100		13.3	15	8	GC-FID	107	575-002
Benzyl acetate	Calculated		10		11.3			GC-FID	91.2	575-002
Benzyl chloride	Calculated		1	1 C	12.9			GC-FID	98.7	575-001
Benzyl chloride	Calculated		1	1 C	12.9			GC-FID	98.9	575-002
Bromobenzene	Calculated				13.8			GC-FID		575-001
Bromodichloromethane (dichlorobromomethane)	Calculated				16.1			GC-FID		575-001
Bromoethane (ethyl bromide)	Calculated		200	250 #	18.5			GC-FID		575-001
Bromoform	Calculated		0.5		15.2			GC-FID		575-001
Bromomethane (methyl bromide)	Calculated			20 C	22.1			GC-FID		575-001
1-Bromopropane (propyl bromide)	Full	1740	0.1		14.4	30	8	GC-FID	100	575-001
1-Bromopropane (propyl bromide)	Full	1740	0.1		14.7	30	8	GC-FID	107	575-002
1,3-Butadiene	Calculated		1	5	19.6			GC-FID		575-001
n-Butane	Calculated				18.1			GC-FID		575-001
n-Butanol (n-butyl alcohol)	Calculated		100	50 #	15.5			GC-FID	94	575-001

See page 212 for abbreviations.

Chemical Hazard	Validation Level	Research Report	OSHA PELs Δ		Sampling Rate (ml/min)	Sampling Time		Analytical Method	DE % §	SKC VOC Chek 575 Cat. No.
			TWA (ppm)	CLG/STEL (ppm)		Min (min)	Max (hrs)			
n-Butanol (n-butyl alcohol)	Calculated		100	50 #	15.5			GC-FID	100	575-002
2-Butanol (sec-butyl alcohol)	Calculated		150	150 #	15.6			GC-FID	93	575-001
2-Butanol (sec-butyl alcohol)	Calculated		150	150 #	15.6			GC-FID	100	575-002
2-Butanone (methyl ethyl ketone, MEK)	Bilevel	1306	200		17.1	15	12	GC-FID	100	575-002
2-Butanone (methyl ethyl ketone, MEK)	OSHA 1004		200		16.88		8	GC-FID	92.3	575-002
2-Butoxyethanol (butyl CELLOSOLVE solvent)	Calculated		50		12			GC-FID	89.7	575-002
n-Butyl acetate	OSHA 1009		150	200 #	13.07	15	8	GC-FID	99.2	575-002
n-Butyl acetate	Partial	1894	150	200 #	12.3	30	8	GC-FID	90.4	575-001
n-Butyl acetate	Partial	1894	150	200 #	13.2	30	8	GC-FID	98.7	575-002
sec-Butyl acetate	Calculated		200		12.8			GC-FID	96.2	575-001
sec-Butyl acetate	Calculated		200		12.8			GC-FID	96.6	575-002
sec-Butyl acetate	OSHA 1009		200		12.74	15	8	GC-FID	98.9	575-002
t-Butyl acetate	Calculated		200		12.7			GC-FID	95.1	575-001
t-Butyl acetate	Calculated		200		12.7			GC-FID	94.8	575-002
t-Butyl acetate	OSHA 1009		200		13.09	15	8	GC-FID	98.9	575-002
Butyl acrylate	Bilevel		10 ‡		11.7	30	8	GC-FID	95	575-002
t-Butyl alcohol	Calculated		100	150	15.8			GC-FID	84	575-002
n-Butyl alcohol (1-butanol)	Calculated		100	50 #	15.5			GC-FID	94	575-001
n-Butyl alcohol (1-butanol)	Calculated		100	50 #	15.5			GC-FID	100	575-002
sec-Butyl alcohol (2-butanol)	Calculated		150	150 #	15.6			GC-FID	93	575-001
sec-Butyl alcohol (2-butanol)	Calculated		150	150 #	15.6			GC-FID	100	575-002
t-Butyl benzene	Calculated				11.3			GC-FID		575-002
Butyl CELLOSOLVE acetate (ethylene glycol monobutyl ether acetate)	Calculated		5		10.4			GC-FID		575-002
t-Butyl ethyl ether (ethyl tert-butyl ether)	Bilevel	1356			13.1	15	8	GC-FID	101	575-001
n-Butyl glycidyl ether	Calculated		50	5.6 ‡	11.6			GC-FID	104	575-002
t-Butyl methyl ether (methyl t-butyl ether, MTBE)	Full	1352			13.6	8.5	8	GC-FID	97.4	575-001
p-tert-Butyl toluene	Bilevel		10		10.4	15	8	GC-FID	100	575-001
n-Butylbenzene	Calculated				11.23			GC-FID	103	575-002
sec-Butylbenzene	Calculated				11.3			GC-FID		575-002
gamma-Butyrolactone	Calculated				16.6			GC-FID	80.9	575-002
Camphor	Calculated		2 mg/m ³		10.8			GC-FID	94.2	575-001
Camphor	Calculated		2 mg/m ³		10.8			GC-FID	113	575-002
Carbolic acid (phenol)	Calculated		5	15.6 C	14.5			GC-FID		575-001 or 575-002
Carbon disulfide	Calculated		20	30	19.54			GC-FID		575-001
Carbon tetrachloride	Bilevel		10	25 C	14.1	30	8	GC-FID	98.3	575-001
2-CELLOSOLVE acetate (2-ethoxyethyl acetate)	Calculated		100		12.1			GC-FID	95.4	575-002
1-Chloro-2-methyl benzene (monochlorotoluene; OXSOL 10)	Bilevel		50 ‡		13	15	8	GC-FID	91.8	575-001
1-Chloro-2-methyl benzene (monochlorotoluene; OXSOL 10)	Bilevel		50 ‡		13	15	8	GC-FID	91	575-002
1-Chloro-4-(trifluoromethyl)benzene (parachlorobenzotrifluoride; OXSOL 100)	Bilevel		25 ◊		11.8	15	8	GC-FID	102	575-001
1-Chloro-4-(trifluoromethyl)benzene (parachlorobenzotrifluoride; OXSOL 100)	Bilevel		25 ◊		11.8	15	8	GC-FID	108	575-002
Chlorobenzene	Partial		75		14.41	15	8	GC-FID	93.3	575-001
Chlorobenzene	Partial	1838	75		14.41	15	8	GC-FID	87.6	575-002
Chlorobromomethane	Calculated		200		18.3			GC-FID	103	575-002
Chloroethane (ethyl chloride)	Calculated		1000		20.02			GC-FID		575-001
Chloroform	Bilevel		10	50 C	13	60	8	GC-FID	97.3	575-001
Chloromethane (methylchloride)	Calculated				24.6			GC-FID		575-001
o-Chlorostyrene	Bilevel	1374	50 ‡		9.8	15	8	GC-FID	75.2	575-002
4-Chlorotoluene	Calculated				12.4			GC-FID		575-001
Cumene (isopropyl benzene)	Bilevel		50		12.8	15	8	GC-FID	99.3	575-001
Cumene (isopropyl benzene)	Bilevel		50		12.8	15	8	GC-FID	106	575-002
Cyclohexane	Bilevel		300		15.6	15	8	GC-FID	105	575-001
Cyclohexane	Bilevel		300		15.6	15	8	GC-FID	109	575-002
Cyclohexanol	Calculated		50		13.5			GC-FID	98	575-001
Cyclohexanol	Calculated		50		13.5			GC-FID	105	575-002
Cyclohexene	Calculated		300		15.4			GC-FID	102	575-001
Cyclohexene	Calculated		300		15.4			GC-FID	106	575-002
Cyclopentane	Calculated				16.8			GC-FID		575-001
p-Cymene (4-isopropyltoluene)	Calculated				11.3			GC-FID		575-001
Decamethylcyclopentasiloxane (D5)	Partial	1891	5 †		5.66	15	8	GC-FID	99	575-001
Decamethyltetrasiloxane	Calculated				7.36			GC-FID		575-001
n-Decane	Partial				12.2			GC-FID	103	575-002
1-Decanol (decyl alcohol)	Calculated				9.6			GC-FID	97.3	575-002
Decyl alcohol (1-decanol)	Calculated				9.6			GC-FID	97.3	575-002
Desflurane	Partial	1893		2	13.8	30	4	GC-FID	94.3	575-002
Diacetone alcohol	Calculated		50		12.4			GC-FID	92.9	575-002
1,2-Dibromo-3-chloropropane	Calculated		1 ppb		12.6			GC-FID	101.3	575-002
Dibromochloromethane	Calculated				15.6			GC-FID		575-001
1,2-Dibromoethane (ethylene dibromide)	Calculated		20	30	15.3			GC-FID	92.3	575-001

See page 212 for abbreviations.

Chemical Hazard	Validation Level	Research Report	OSHA PELs Δ		Sampling Rate (ml/min)	Sampling Time		Analytical Method	DE % §	SKC VOC Chek 575 Cat. No.
			TWA (ppm)	CLG/STEL (ppm)		Min (min)	Max (hrs)			
1,2-Dibromoethane (ethylene dibromide)	Calculated		20	30	15.3			GC-FID	99.4	575-002
1, 6-Dibromohexane (hexamethylene dibromide)	Calculated				10.7			GC-FID		575-001
o-Dichlorobenzene (1,2-dichlorobenzene)	Partial			50 C	12.5	15	8	GC-FID	79.2	575-001
o-Dichlorobenzene (1,2-dichlorobenzene)	Partial	1875		50	12.5	15	8	GC-FID	77.1	575-002
m-Dichlorobenzene (1,3-dichlorobenzene)	Calculated				12.95			GC-FID	91.8	575-001
m-Dichlorobenzene (1,3-dichlorobenzene)	Calculated				12.95			GC-FID	92.7	575-002
p-Dichlorobenzene (1,4-dichlorobenzene)	Calculated		75		12.95			GC-FID	91.1	575-001
p-Dichlorobenzene (1,4-dichlorobenzene)	Calculated		75		12.95			GC-FID	94.7	575-002
1,3-Dichlorobenzene (m-dichlorobenzene)	Calculated				12.95			GC-FID	91.8	575-001
1,3-Dichlorobenzene (m-dichlorobenzene)	Calculated				12.95			GC-FID	92.7	575-002
1,2-Dichlorobenzene (o-dichlorobenzene)	Partial			50 C	12.5	15	8	GC-FID	79.2	575-001
1,2-Dichlorobenzene (o-dichlorobenzene)	Partial	1875		50 C	12.5	15	8	GC-FID	77.1	575-002
1,4-Dichlorobenzene (p-dichlorobenzene)	Calculated		75		12.95			GC-FID	91.1	575-001
1,4-Dichlorobenzene (p-dichlorobenzene)	Calculated		75		12.95			GC-FID	94.7	575-002
Dichlorobromomethane (bromodichloromethane)	Calculated				16.1			GC-FID		575-001
Dichlorodifluoromethane (Freon 12)	Calculated		1000		18.6			GC-FID		575-001
1,1-Dichloroethane	Calculated		100		16.85			GC-FID		575-001
1,2-Dichloroethane (ethylene dichloride)	Bilevel		50	100	14.2	60	8	GC-FID	95.8	575-001
1,2-Dichloroethene (1,2-dichloroethylene)	Full				14.8	15	8	GC-FID	97.1	575-001
1,1-Dichloroethene (vinylidene chloride)	Bilevel		1		12.3	60	8	GC-FID	95.2	575-001
Dichloroethyl ether	Calculated		5 ‡	15 C	12.5			GC-FID		575-001
1,2-Dichloroethylene (1,2-dichloroethene)	Full		200		14.8	15	8	GC-FID	97.1	575-001
1,2-Dichloroethylene (1,2-dichloroethene)	Full				14.8	15	8	GC-FID	97.1	575-001
Dichloromethane (methylene chloride)	Full	1323	25	125	14.7	240	8 π	GC-FID	96	575-001
Dichloromethane (methylene chloride)	Full	1323	25	125	16	15	4	GC-FID	96	575-001
1,2-Dichloropropane (propylene dichloride)	Bilevel		75		14.3	15	8	GC-FID	97.7	575-001
1,1-Dichloropropene	Calculated				15.6			GC-FID		575-001
cis-1,3-Dichloropropene	Partial	1886	1 ‡		13.6	15	8	GC-FID	101	575-002
trans-1,3-Dichloropropene	Partial	1886			14.4	15	8	GC-FID	99.4	575-002
1,2-Dichlorotetrafluoroethane (Freon 114)	Calculated		1000		15.3			GC-FID		575-001
Dicyclopentadiene	Calculated		5 ‡		11.8			GC-FID		575-001
Diethyl ether (ethyl ether)	Calculated		400		16.4			GC-FID		575-001
Diethyl ketone (3-pentanone)	Calculated		200 ‡		14.8			GC-FID	83.9	575-001
Diethyl ketone (3-pentanone)	Calculated		200 ‡		14.8			GC-FID	100.3	575-002
Diethylene glycol dimethyl ether (2-methoxyethyl ether)	Calculated				11.5			GC-FID		575-002
Diethylene glycol monobutyl ether	Calculated				9.97			GC-FID		575-002
Diethylene glycol monoethyl ether	Calculated				9.85			GC-FID		575-002
Diethylene glycol monoethyl ether acetate	Calculated				9.88			GC-FID		575-002
Diethylene glycol monomethyl ether (2-[2-methoxyethoxy] ethanol)	Calculated				11.3			GC-FID		575-002
Diisobutyl ketone (DIBK), (isovalerone)	Bilevel	1305	50		10.3	30	8	GC-FID	98.3	575-002
1,2-Dimethoxyethane (ethylene glycol dimethyl ether)	Calculated				14.7			GC-FID		575-001 or 575-002
Dimethoxymethane (methylal)	Calculated		1000		17.1			GC-FID		575-001
Dimethyl adipate	Calculated				10.73			GC-FID		575-001
Dimethyl disulfide	Calculated				15.4			GC-FID		575-001
2,5-Dimethyl hexane	Calculated				11.86			GC-FID		575-001
2,2-Dimethyl methane	Calculated				21.7			GC-FID		575-001
Dimethyl pentanedioate	Calculated				10.8			GC-FID		575-001
Dimethyl sulfide	Calculated				19			GC-FID		575-001
Dimethyl sulfoxide	Calculated				16.3			GC-FID		575-002
N,N-Dimethylaniline	Calculated		5		12			GC-FID		575-001
2,2-Dimethylbutane (neohexane)	Calculated				14.2			GC-FID		575-001
trans-1,2-Dimethylcyclohexane	Calculated				12.4			GC-FID	106.1	575-001
N,N-Dimethylformamide (DMF)	Calculated		10		16.4			GC-FID	87.2	575-002
2,3-Dimethylpentane	Calculated				12.8			GC-FID		575-001
1,4-Dioxane	Calculated		100		15.8			GC-FID	91.4	575-002
Diphenyl oxide (phenyl ether)	Calculated		1		10.4			GC-FID		575-001
Dipropyl ketone (4-heptanone)	Calculated		50 ‡		12.1			GC-FID	85.3	575-001
Dipropyl ketone (4-heptanone)	Calculated		50 ‡		12.1			GC-FID	112	575-002
Dipropylene glycol methyl ether	Calculated		100		10.8			GC-FID	84.3	575-002
Dodecamethylcyclohexasiloxane	Calculated				6.75			GC-FID		575-001
n-Dodecanol (lauryl alcohol)	Calculated				8.7			GC-FID	107.5	575-001
n-Dodecanol (lauryl alcohol)	Calculated				8.7			GC-FID	103	575-002
1-Dodecene	Calculated				9.29			GC-FID		575-001
1-Dodecyl alcohol (lauryl alcohol)	Calculated				8.7			GC-FID	107.5	575-001
1-Dodecyl alcohol (lauryl alcohol)	Calculated				8.7			GC-FID	103	575-002
Dodecyl methacrylate	Calculated				7.6			GC-FID		575-002
Enflurane (ethrane)	Partial	1893		2	13.8	30	4	GC-FID	101	575-002
Epichlorohydrin	Calculated		5		16.4			GC-FID	88.2	575-002
2,3-Epoxy-1-propanol (glycidol)	Calculated		50		17.8			GC-FID		575-002
2,3-Epoxypropyl methacrylate (glycidyl methacrylate)	Calculated				11.45			GC-FID		575-002

See page 212 for abbreviations.

Chemical Hazard	Validation Level	Research Report	OSHA PELs Δ		Sampling Rate (ml/min)	Sampling Time		Analytical Method	DE % §	SKC VOC Chek 575 Cat. No.
			TWA (ppm)	CLG/STEL (ppm)		Min (min)	Max (hrs)			
Ethanol (ethyl alcohol)	Partial	1876	1000		20.3	15	8	GC-FID	99	575-002
2-Ethoxyethanol	Calculated		200		14.4			GC-FID	100.8	575-001
2-Ethoxyethanol	Calculated		200		14.4			GC-FID	111.2	575-002
2-Ethoxyethyl acetate (2-CELLOSOLVE acetate)	Calculated		100		12.1			GC-FID	95.4	575-002
Ethane (enflurane)	Partial	1893		2	13.8	30	4	GC-FID	101	575-002
Ethyl acetate	Partial	1894	400		13.1	30	8	GC-FID	92.8	575-001
Ethyl acetate	Partial	1894	400		14.1	30	8	GC-FID	100	575-002
Ethyl acrylate	Bilevel		5		13.7	15	8	GC-FID	94.2	575-002
Ethyl alcohol (ethanol)	Partial	1876	1000		20.3	15	8	GC-FID	99	575-002
Ethyl benzene	Bilevel		100		12.9	15	6	GC-FID	100	575-001
Ethyl benzene	Bilevel		100		12.9	15	6	GC-FID	104	575-002
Ethyl benzene	OSHA 1002		100		13.83		8	GC-FID	99.1	575-002
Ethyl bromide (bromoethane)	Calculated		200	250 #	18.5			GC-FID		575-001
Ethyl butyl ketone (3-heptanone)	Calculated		50		12.2			GC-FID	87.9	575-001
Ethyl butyl ketone (3-heptanone)	Calculated		50		12.2			GC-FID	103.4	575-002
Ethyl chloride (chloroethane)	Calculated		1000		20.2			GC-FID		575-001
Ethyl cyanide	Calculated				18.61			GC-FID		575-001
Ethyl ether	Calculated		400		16.4			GC-FID		575-001
Ethyl formate	Calculated		100		17.8			GC-FID		575-001
2-Ethyl hexyl acetate	Calculated				9.8			GC-FID	99	575-002
Ethyl methacrylate	Full		100		13.1	15	8	GC-FID	84.7	575-001
Ethyl methacrylate	Full		100		13.1	15	8	GC-FID	104	575-002
Ethyl propionate	Calculated				14			GC-FID		575-001
Ethyl tert-butyl ether (tert-butyl ethyl ether)	Bilevel	1356			13.1	15	8	GC-FID	101	575-001
Ethylene dibromide (1,2-dibromoethane)	Calculated		20	30	15.3			GC-FID	92.3	575-001
Ethylene dibromide (1,2-dibromoethane)	Calculated		20	30	15.3			GC-FID	99.4	575-002
Ethylene dichloride (1,2-dichloroethane)	Bilevel		50	100 C	14.2	60	8	GC-FID	95.8	575-001
Ethylene glycol	Calculated			100 mg/m³ C	17.44			GC-FID		575-002
Ethylene glycol diethyl ether	Calculated				12.27			GC-FID		575-002
Ethylene glycol dimethyl ether (1,2-dimethoxyethane)	Calculated				14.7			GC-FID		575-001 or 575-002
Ethylene glycol monobutyl ether acetate (butyl CELLOSOLVE acetate)	Calculated		5		10.4			GC-FID		575-002
Ethylene glycol monohexyl ether	Calculated				10.5			GC-FID		575-001
Ethylene glycol monomethyl ether acetate (methyl CELLOSOLVE acetate)	Calculated		25		12.9			GC-FID	92.4	575-002
Ethylene oxide	Full	1543	1	5 EL	21.2	15	8	GC-ECD	102	575-005
2-Ethylhexanol	Calculated				10.93			GC-FID	93.7	575-002
2-Ethyltoluene	Calculated				12.1			GC-FID	106	575-002
3-Ethyltoluene	Calculated				12.1			GC-FID	101	575-002
4-Ethyltoluene	Calculated				12.1			GC-FID	91	575-002
Freon 11 (trichlorofluoromethane)	Calculated				16.65			GC-FID		575-001
Freon 113 (1,1,2-trichloro-1,2,2-trifluoroethane)	Calculated		1000	1250 #	14.1			GC-FID		575-001
Freon 114 (1,2-dichlorotetrafluoroethane)	Calculated		1000		15.3			GC-FID		575-001
Freon 12 (dichlorodifluoromethane)	Calculated		1000		18.6			GC-FID		575-001
Glutaric acid dimethyl ester	Calculated				11.5			GC-FID		575-002
Glycidol (2,3-epoxy-1-propanol)	Calculated		50		17.8			GC-FID		575-002
Glycidyl methacrylate (2,3-epoxypropyl methacrylate)	Calculated				11.45			GC-FID		575-002
Halothane	Full	1893			14.1	15	8	GC-FID	99.9	575-002
n-Heptane	Bilevel		500		13.9	15	8	GC-FID	105	575-001
n-Heptane	Bilevel		500		13.9	15	8	GC-FID	108	575-002
4-Heptanone (dipropyl ketone)	Calculated		50 ‡		12.1			GC-FID	85.3	575-001
4-Heptanone (dipropyl ketone)	Calculated		50 ‡		12.1			GC-FID	112.2	575-002
3-Heptanone (ethyl butyl ketone)	Calculated		50		12.2			GC-FID	87.9	575-001
3-Heptanone (ethyl butyl ketone)	Calculated		50		12.2			GC-FID	103.4	575-002
2-Heptanone (methyl n-amyl ketone)	Calculated		100		12.2			GC-FID	99.8	575-002
1-Heptene	Calculated				13.1			GC-FID		575-001
Hexachlorobutadiene	Calculated		0.02 ‡		10.5			GC-FID		575-001
Hexachloroethane	Calculated		1		11.5			GC-FID		575-001
Hexadecane	Calculated				7.7			GC-FID		575-001
Hexamethyldisiloxane (L2)	Partial	1892	200 †		9.98	15	8	GC-FID	102.9	575-001
Hexamethylene dibromide (1,6-dibromohexane)	Calculated				10.7			GC-FID		575-001
n-Hexane	Bilevel		500		14.3	15	8	GC-FID	100	575-001
n-Hexane	Bilevel		500		14.3	15	8	GC-FID	112	575-002
Hexanol (hexyl alcohol)	Calculated				12.64			GC-FID	92.9	575-002
2-Hexanone (methyl butyl ketone MBK)	Partial	1873	100		14.3	15	8	GC-FID	104	575-002
2-Hexene	Calculated				14.5			GC-FID		575-001
Hexone (methyl isobutyl ketone [MIBK])	Bilevel	1304	100		13.5	30	8	GC-FID	94.6	575-002
Hexone (methyl isobutyl ketone [MIBK])	OSHA 1004		100		13.62		8	GC-FID	92.9	575-002
sec-Hexyl acetate	Calculated		50		11.1			GC-FID		575-002
Hexyl alcohol (hexanol)	Calculated				12.64			GC-FID	92.9	575-002
Hexylene	Calculated				14.5			GC-FID		575-001

See page 212 for abbreviations.

Chemical Hazard	Validation Level	Research Report	OSHA PELs Δ		Sampling Rate (ml/min)	Sampling Time		Analytical Method	DE % §	SKC VOC Chek 575 Cat. No.
			TWA (ppm)	CLG/STEL (ppm)		Min (min)	Max (hrs)			
Hexylene glycol	Calculated			25 C	11.81			GC-FID		575-002
Iodomethane (methyl iodide)	Calculated				18.7			GC-FID		575-001
Isoamyl acetate	Calculated		100		11.9			GC-FID	91.9	575-001
Isoamyl acetate	Calculated		100		11.9			GC-FID	108	575-002
Isoamyl alcohol	Calculated		100	125 #	13.9			GC-FID		575-002
Isobutyl acetate	Calculated		150		12.8			GC-FID	106	575-002
Isobutyl acetate	OSHA 1009		150		13.16	15	8	GC-FID	99.1	575-002
Isobutyl acrylate	Calculated				12.2			GC-FID		575-002
Isobutyl alcohol	Calculated		100		15.6			GC-FID	93	575-001
Isobutyl alcohol	Calculated		100		15.6			GC-FID	100	575-002
Isoflurane	Full	1893			13.2	15	8	GC-FID	96	575-002
Isooctyl alcohol	Calculated		50 ‡		10.9			GC-FID		575-002
Isopentane (2-methyl butane)	Calculated		1000	610 #	15.8			GC-FID		575-001
Isophorone	Calculated		25		11.3			GC-FID		575-002
Isopropanol (isopropyl alcohol)	Partial	1839	400	500 #	18.42	15	8	GC-FID	103.5	575-002
Isopropyl acetate	Calculated		250		14.2			GC-FID	88.5	575-001
Isopropyl acetate	Calculated		250		14.2			GC-FID	101	575-002
Isopropyl alcohol (isopropanol)	Partial	1839	400	500 #	18.42	15	8	GC-FID	103.5	575-002
Isopropyl benzene (cumene)	Bilevel		50		12.8	15	8	GC-FID	99.3	575-001
Isopropyl benzene (cumene)	Bilevel		50		12.8	15	8	GC-FID	106	575-002
Isopropyl ether	Calculated		500		13.4			GC-FID		575-001
Isopropyl glycidyl ether	Calculated		50	50 #	12.8			GC-FID		575-001
4-Isopropyltoluene (p-cymene)	Calculated				11.3			GC-FID		575-001
Isovalerone (diisobutyl ketone [DIBK])	Bilevel	1308	50		10.3	30	8	GC-FID	98.3	575-002
Lauryl alcohol (1-dodecanol)	Calculated				8.7			GC-FID	107.5	575-001
Lauryl alcohol (1-dodecanol)	Calculated				8.7			GC-FID	103	575-002
Limonene	Calculated				11.1			GC-FID	102	575-002
Mesityl oxide	Calculated		25		13.7			GC-FID		575-001
Mesitylene (1,3,5-trimethylbenzene)	Calculated		25 ¶		12.1			GC-FID	93.6	575-001
Mesitylene (1,3,5-trimethylbenzene)	Calculated		25 ¶		12.1			GC-FID	96	575-002
Methanol (methyl alcohol)	Partial	1895	200	250	1.2	15	8	GC-FID	101	575-007
2-Methoxy-1-propyl acetate	Calculated				12.1			GC-FID		575-002
1-Methoxy-2-propanol (propylene glycol monomethyl ether)	Calculated		100 ‡	150 #	14.7			GC-FID	82.9	575-001
1-Methoxy-2-propanol (propylene glycol monomethyl ether)	Calculated		100 ‡	150 #	14.7			GC-FID	100	575-002
1-Methoxy-2-propyl acetate (propylene glycol monomethyl ether acetate)	Calculated				12.2			GC-FID	108	575-001
1-Methoxy-2-propyl acetate (propylene glycol monomethyl ether acetate)	Calculated				12.1			GC-FID	103	575-002
2-Methoxyethanol (methyl CELLOSOLVE)	Calculated		0.1		16.1			GC-FID	94.7	575-001
2-Methoxyethanol (methyl CELLOSOLVE)	Calculated		0.1		16.1			GC-FID	91.1	575-002
2-[2-Methoxyethoxy] ethanol (diethylene glycol monomethyl ether)	Calculated				11.3			GC-FID		575-002
2-Methoxyethyl ether (diethylene glycol dimethyl ether)	Calculated				11.5			GC-FID	100	575-002
Methoxyflurane	Calculated			2	13.3			GC-FID	95.7	575-002
Methyl acetate	Calculated		200	250 #	17.8			GC-FID		575-002
Methyl acrylate	Full		10		15.7	15	8	GC-FID	94.3	575-002
Methyl alcohol (Methanol)	Partial	1895	200	250	1.2	15	8	GC-FID	101	575-007
Methyl amyl alcohol (methyl isobutyl carbinol)	Calculated		25		12.8			GC-FID		575-002
Methyl bromide (bromomethane)	Calculated			20C	22.1			GC-FID		575-002
2-Methyl butane (isopentane)	Calculated		1000	610 #	15.8			GC-FID		575-001
Methyl butyl ketone (MBK), (2-hexanone)	Partial	1873	100		14.3	15	8	GC-FID	104	575-002
Methyl CELLOSOLVE (2-methoxyethanol)	Calculated		0.1		16.1			GC-FID	94.7	575-001
Methyl CELLOSOLVE (2-methoxyethanol)	Calculated		0.1		16.1			GC-FID	91.1	575-002
Methyl CELLOSOLVE acetate (ethylene glycol monomethyl ether acetate)	Calculated		25		12.9			GC-FID	92.4	575-002
Methyl chloroform (1,1,1-trichloroethane)	Bilevel		350		14.1	15	8	GC-FID	99.9	575-001
Methyl cyclohexane	Bilevel		500		14.2	15	8	GC-FID	106	575-001
Methyl ethyl ketone (MEK), (2-butanone)	Bilevel	1306	200		17.1	15	12	GC-FID	100	575-002
Methyl ethyl ketone (MEK), (2-butanone)	OSHA 1004		200		16.88		8	GC-FID	92.3	575-002
Methyl formate	Calculated		100		20.58			GC-FID		575-001
Methyl iodide (iodomethane)	Calculated				18.7			GC-FID		575-001
Methyl isoamyl ketone	Calculated		50		12.3			GC-FID		575-002
Methyl isobutyl carbinol (methyl amyl alcohol)	Calculated		25		12.8			GC-FID		575-002
Methyl isobutyl ketone (MIBK), (hexone)	Bilevel	1304	100		13.5	30	8	GC-FID	94.6	575-002
Methyl isobutyl ketone (MIBK), (hexone)	OSHA 1004		100		13.62		8	GC-FID	92.9	575-002
Methyl isopropyl ketone	Calculated				14.8			GC-FID		575-002
Methyl isothiocyanate	Calculated				17.36			GC-FID		575-001
Methyl methacrylate (MMA)	Bilevel	1308	100		13.1	7.5	8	GC-FID	100.5	575-002
Methyl n-amyl ketone (2-heptanone)	Calculated		100		12.2			GC-FID	99.8	575-002
2-Methyl pentane	Calculated				14.1			GC-FID		575-001
Methyl propyl ketone (2-pentanone)	Calculated		200		14.8			GC-FID	92.6	575-002

See page 212 for abbreviations.

Chemical Hazard	Validation Level	Research Report	OSHA PELs Δ		Sampling Rate (ml/min)	Sampling Time		Analytical Method	DE % §	SKC VOC Chek 575 Cat. No.
			TWA (ppm)	CLG/STEL (ppm)		Min (min)	Max (hrs)			
3-Methyl pyrrolidinone	Calculated				13.28			GC-FID		575-002
Methyl styrene (vinyl toluene)	Calculated		100		12.3			GC-FID		575-001
Methyl t-butyl ether (MTBE)	Full	1352			13.6	8.5	8	GC-FID	97.4	575-001
Methyl tert-amyl ether (tert-amyl methyl ether)	Bilevel	1355			13.1	30	8	GC-FID	99	575-001
n-Methyl-2-pyrrolidinone	Calculated		51		13.97			GC-FID		575-001
5-Methyl-3-heptanone	Calculated		25		11.4			GC-FID	87.5	575-001
5-Methyl-3-heptanone	Calculated		25		11.4			GC-FID	110.7	575-002
Methylal (dimethoxymethane)	Calculated		1000		17.1			GC-FID		575-001
Methylchloride (chloromethane)	Calculated				24.6			GC-FID		575-002
1-Methylcyclohexanol	Full		100		12.4	15	8	GC-FID	94.7	575-001
1-Methylcyclohexanol	Full		100		12.4	15	8	GC-FID	108	575-002
Methylcyclopentane	Calculated				14.9			GC-FID		575-001
Methylene chloride (dichloromethane)	Full	1323	25	125	16	15	4	GC-FID	96	575-001
Methylene chloride (dichloromethane)	Full	1323	25	125	14.7	240	8 π	GC-FID	96	575-001
3-Methylhexane	Calculated				12.8			GC-FID		575-001
alpha-Methylstyrene	Bilevel	1359		100 C	12.6	15	12	GC-FID	95.7	575-002
Mineral spirits	Calculated		500		10.95			GC-FID		575-001
Monochlorotoluene (1-chloro-2-methylbenzene; OXSOL 10)	Bilevel		50 ‡		13	15	8	GC-FID	91.8	575-001
Monochlorotoluene (1-chloro-2-methylbenzene; OXSOL 10)	Bilevel		50 ‡		13	15	8	GC-FID	91	575-002
Neohexane (2,2-dimethylbutane)	Calculated				14.2			GC-FID		575-001
Nitrobenzene	Calculated				12.6			GC-FID		575-001
Nonane	Bilevel				10.6	15	8	GC-FID	103	575-001
Nonyl alcohol	Calculated				10.2			GC-FID	96.8	575-002
Octadecane	Calculated				7.1			GC-FID		575-001
Octamethylcyclotetrasiloxane (D4)	Partial	1890	10 ▼		6.32	15	8	GC-FID	97.2	575-001
Octamethyltrisiloxane (L3)	Partial	1902	200 †		8.47	15	8	GC-FID	98.3	575-001
n-Octane	Bilevel		500		12.7	15	8	GC-FID	106	575-001
n-Octane	Bilevel		500		12.7	15	8	GC-FID	110	575-002
Octanol (octyl alcohol)	Calculated				10.86			GC-FID		575-002
1-Octene	Calculated				11.99			GC-FID		575-001
Octyl alcohol (octanol)	Calculated				10.86			GC-FID		575-002
OXSOL 10 (monochlorotoluene [1-chloro-2-methyl benzene])	Bilevel		50 ‡		13	15	8	GC-FID	91.8	575-001
OXSOL 10 (monochlorotoluene [1-chloro-2-methyl benzene])	Bilevel		50 ‡		13	15	8	GC-FID	91	575-002
Parachlorobenzotrifluoride (1-chloro-4-[trifluoromethyl]benzene; OXSOL 100)	Bilevel		25 ◊		11.8	15	8	GC-FID	102	575-001
Parachlorobenzotrifluoride (1-chloro-4-[trifluoromethyl]benzene; OXSOL 100)	Bilevel		25 ◊		11.8	15	8	GC-FID	108	575-002
Pentadecane	Calculated				7.93			GC-FID		575-001
n-Pentane	Full	1311	1000		14.9	15	8	GC-FID	105.2	575-001
3-Pentanone (diethyl ketone)	Calculated		200 ‡		14.8			GC-FID	83.9	575-001
3-Pentanone (diethyl ketone)	Calculated		200 ‡		14.8			GC-FID	100.3	575-002
2-Pentanone (methyl propyl ketone)	Calculated		200		14.8			GC-FID	92.6	575-002
1-Pentene	Calculated				16.3			GC-FID		575-001
2-Pentyl acetate (sec-amyl acetate)	Calculated		125		11.8			GC-FID		575-001
Perchloroethylene (tetrachloroethylene)	Full	1686	100	200 C	13.1	7.5	12	GC-FID	100.8	575-001
Perchloroethylene (tetrachloroethylene)	OSHA 1001		100	200 C	13.06	5	8	GC-FID	95.4	575-002
Perfluoromethylcyclohexane	Partial				10.2			GC-FID	102	575-002
Phenol (carbolic acid)	Calculated		5	15.6 C	14.5			GC-FID		575-001 or 575-002
Phenyl ether (diphenyl oxide)	Calculated		1		10.4			GC-FID		575-001
Phenyl glycidyl ether	Calculated		10		11.6			GC-FID		575-001
4-Phenylcyclohexene	Calculated				11.53			GC-FID		575-001 or 575-002
alpha-Pinene	Partial	1840			11.3	15	8	GC-FID	108.6	575-002
Propane	Calculated		1000		21.73			GC-FID		575-001
n-Propanol (propyl alcohol)	Calculated		200		17.7			GC-FID	87.3	575-001
n-Propanol (propyl alcohol)	Calculated		200		17.7			GC-FID	97.8	575-002
Propionitrile	Calculated		6 ‡		18.61			GC-FID		575-001
n-Propyl acetate	Calculated		200		14.1			GC-FID	87.5	575-001
n-Propyl acetate	Calculated		200		14.1			GC-FID	101.1	575-002
Propyl alcohol (n-propanol)	Calculated		200		17.7			GC-FID	87.3	575-001
Propyl alcohol (n-propanol)	Calculated		200		17.7			GC-FID	97.8	575-002
Propyl bromide (1-bromopropane)	Full	1740	0.1		14.4	30	8	GC-FID	100	575-001
Propyl bromide (1-bromopropane)	Full	1740	0.1		14.7	30	8	GC-FID	107	575-002
n-Propylbenzene	Calculated				12.1			GC-FID	101	575-002
Propylene dichloride (1,2-dichloropropane)	Bilevel		75		14.3	15	8	GC-FID	97.7	575-001
Propylene glycol monomethyl ether (1-methoxy-2-propanol)	Calculated		100 ‡	150 #	14.7			GC-FID	82.9	575-001
Propylene glycol monomethyl ether (1-methoxy-2-propanol)	Calculated		100 ‡	150 #	14.7			GC-FID	100	575-002
Propylene glycol monomethyl ether acetate (1-methoxy-2-propyl acetate)	Calculated				12.2			GC-FID	108	575-001
Propylene glycol monomethyl ether acetate (1-methoxy-2-propyl acetate)	Calculated				12.1			GC-FID	103	575-002

See page 212 for abbreviations.

Chemical Hazard	Validation Level	Research Report	OSHA PELs Δ		Sampling Rate (ml/min)	Sampling Time		Analytical Method	DE % §	SKC VOC Chek 575 Cat. No.
			TWA (ppm)	CLG/STEL (ppm)		Min (min)	Max (hrs)			
Propylene oxide	Calculated		100		19.9			GC-FID	98	575-001
Propylene oxide	Calculated		100		19.9			GC-FID	99.7	575-002
Pyridine	Calculated		5		16.6			GC-FID	88.2	575-002
Sevoflurane	Partial	1893		2	12.8	30	4		100	575-002
Solvent naphtha (petroleum) light aromatic	Calculated				11.61			GC-FID		575-001 or 575-002
Stoddard solvent	Calculated		500		10.95			GC-FID		575-001
Styrene	Full	1313	100	200 C	13.7	15	8	GC-FID	86.3	575-002
Styrene	OSHA 1014		100	200 C	13.55	15	8	GC-FID	96.7	575-006
1,1,1,2-Tetrachloroethane	Calculated				13.63			GC-FID	98.3	575-002
1,1,2,2-Tetrachloroethane	Bilevel		5		11.8	480 *	8	GC-FID	64.4 ∞	575-001
Tetrachloroethylene (perchloroethylene)	Full	1686	100	200 C	13.1	7.5	12	GC-FID	100.8	575-001
Tetrachloroethylene (perchloroethylene)	OSHA 1001		100	200 C	13.06	5	8	GC-FID	95.4	575-002
Tetradecane	Calculated				8.3			GC-FID		575-001
Tetrahydrofuran	Partial	1841	200		17.7	15	8	GC-FID	100.6	575-002
1,2,3,4-Tetramethylbenzene	Calculated				11.1			GC-FID		575-001
1,2,3,5-Tetramethylbenzene	Calculated				10.8			GC-FID		575-001
1,2,4,5-Tetramethylbenzene	Calculated				11.2			GC-FID	86.6	575-002
Toluene	Bilevel		200	300 C	14.5	15	8	GC-FID	97.9	575-001
Toluene	OSHA 111		200	300 C	14.89	10	8	GC-FID	97	575-002
1,1,2-Trichloro-1,2,2-trifluoroethane (Freon 113)	Calculated		1000	1250 #	14.1			GC-FID		575-001
1,2,3-Trichlorobenzene	Calculated				11.34			GC-FID		575-001
1,2,4-Trichlorobenzene	Calculated			5 C	11.4			GC-FID		575-001
1,1,2-Trichloroethane	Bilevel		10		12.5	15	8	GC-FID	96.7	575-001
1,1,1-Trichloroethane (methyl chloroform)	Bilevel		350		14.1	15	8	GC-FID	99.9	575-001
Trichloroethylene	Full		100	200 C	14.9	15	8	GC-FID	102	575-001
Trichloroethylene	OSHA 1001		100	200 C	14.24	5	8	GC-FID	97.5	575-002
Trichlorofluoromethane (Freon 11)	Calculated				16.65			GC-FID		575-001
1,2,3-Trichloropropane	Bilevel		50		11.9	15	8	GC-FID	98.1	575-001
Tridecane	Calculated				9.2			GC-FID		575-001
Trifluoromethyl benzene (benzotrifluoride; OXSOL 2000)	Bilevel		100		13.3	15	8	GC-FID	106	575-001
Trifluoromethyl benzene (benzotrifluoride; OXSOL 2000)	Bilevel		100		13.3	15	8	GC-FID	107	575-002
1,2,3-Trimethylbenzene	Calculated		25 †		12			GC-FID	91.1	575-001
1,2,3-Trimethylbenzene	Calculated		25 †		12	15	8	GC-FID	93.8	575-002
1,2,4-Trimethylbenzene	Partial		25 †		13.05			GC-FID	88.4	575-001
1,2,4-Trimethylbenzene	Partial	1837	25 †		13.05	15	8	GC-FID	88.9	575-002
1,3,5-Trimethylbenzene (mesitylene)	Calculated		25 †		12.1			GC-FID	93.6	575-001
1,3,5-Trimethylbenzene (mesitylene)	Calculated		25 †		12.1			GC-FID	96	575-002
2,2,4-Trimethylpentane	Calculated				11.89			GC-FID		575-001
n-Undecane	Calculated				9.62			GC-FID		575-001
Vinyl acetate	Full	1860		4 C #	16.4	30	8	GC-FID	92	575-002
Vinyl bromide	Calculated		LFC ‡		19.6			GC-FID		575-001
Vinyl chloride	Calculated		1		21.4			GC-FID		575-001
Vinyl toluene (methyl styrene)	Calculated		100		12.3			GC-FID		575-001
n-Vinyl-2-pyrrolidone	Calculated				13.9			GC-FID		575-001
4-Vinylcyclohexene	Calculated				12.4			GC-FID		575-001
Vinylidene chloride (1,1-dichloroethene)	Bilevel		1		12.3	60	8	GC-FID	95.2	575-001
m-Xylene	Bilevel		100	150 #	12.5	15	8	GC-FID	96.6	575-001
m-Xylene	Bilevel		100	150 #	12.5	15	8	GC-FID	101	575-002
m-Xylene	OSHA 1002		100	150 #	13.82		8	GC-FID	96.1	575-002
o-Xylene	Bilevel		100	150 #	11.9	15	8	GC-FID	91	575-001
o-Xylene	OSHA 1002		100	150 #	14.24		8	GC-FID	89.4	575-002
p-Xylene	Bilevel		100	150 #	12.8	15	8	GC-FID	95.6	575-001
p-Xylene	Bilevel		100	150 #	12.8	15	8	GC-FID	103	575-002
p-Xylene	OSHA 1002		100	150 #	13.94		8	GC-FID	95.3	575-002

* Lower than the NIOSH-accepted guideline
 # NIOSH Short Term Exposure Limit (STEL)
 ∞ Depends on detector sensitivity
 † In-house exposure level
 ‡ NIOSH Recommended Exposure Limit (REL)
 ◊ Occidental Chemical corporate exposure limits
 ≈ Valid for PEL samples greater than 4 hours duration. If more than 1000 ppm of other contaminants are present, reduce maximum sample time to 4 hours.
 Δ Agency standards for OSHA listings represent the OSHA PELs reported in 29 CFR 1910.1000 Part 1910, Section 1000.

§ The values given for the desorption efficiency were obtained in SKC Inc. laboratories. See the online guide at www.skccinc.com for details on the desorption solvent used.
 ¶ OSHA construction industry standards
 √ Valid for STEL samples up to 4 hours duration
 π If more than 1000 ppm contaminants are present, reduce maximum sample time to 4 hours.
 ▼ OARS-WEEL TWA Level (Occupational Alliance for Risk Science - Workplace Environmental Exposure Levels)
 EL Excursion Limit
 LFC Lowest feasible concentration

More information at www.skccinc.com – search “Passive”

See page 212 for abbreviations.

Passive Samplers for Health Care Anesthetic Gases

Halogenated Ethers

Isoflurane and enflurane are used primarily in veterinary procedures. Isoflurane and halothane are being replaced by desflurane and sevoflurane, which have fewer health effects. Exposure to halogenated ethers can cause eye, skin, and respiratory tract irritation; eye damage; and other serious health effects.

SKC VOC Chek 575 Passive Samplers

- ▶ Validated sampling rates for each gas
- ▶ Lightweight and miniature size
- ▶ No pump or assembly required
- ▶ Easy sorbent transfer during analysis



Description	Pkg. of 5 Cat. No.	Pkg. of 25 Cat. No.
Organic Vapors Passive Sampler contains 500 mg Anasorb 747	575-002†	575-002A†

† Larger quantity packages are available. Contact SKC.

See details on pages 80-81.

Ethylene Oxide (EtO)

Ethylene oxide is used to sterilize medical equipment and supplies. Exposure health effects can range from respiratory irritation to cancer and reproductive/mutagenic effects.

SKC Ethylene Oxide Passive Sampler

- ▶ Uses same sorbent as active OSHA Method 1010
- ▶ Fully validated for 8-hour and 15-minute sampling
- ▶ Lightweight and miniature size
- ▶ No pump or assembly required



Description	Pkg. of 5 Cat. No.	Pkg. of 25 Cat. No.
Ethylene Oxide Passive Sampler contains 500 mg Anasorb 747 treated with hydrobromic acid	575-005†	575-005A†

† Larger quantity packages are available. Contact SKC.

For passive samplers for Aldehydes, see page 84.

ABOUT

Sampling Anesthetic Gases

OSHA Anesthetic Gases Guidelines for Workplace Exposures recommend air sampling for anesthetic gases every six months to measure worker exposures and to check control measure effectiveness. Personal sampling provides the best estimate of exposure level and is the preferred method for determining worker time-weighted average (TWA) exposure during anesthetic administration and in the post-anesthesia care unit (PACU). Go to www.osha.gov/dts/osta/anestheticgases/index.html for detailed guidelines.

ABOUT

Sampling Peracetic Acid (PAA) — an Alternate Sterilant

While no passive sampler is available for PAA, SKC offers treated sorbent tubes Cat. Nos. 226-193-UC and 226-199-UC (page 42) and coated filter Cat. No. 225-9030 (page 63) to be used in a sampling train for PAA and hydrogen peroxide. See page 42 for details.



Research Reports available at www.skcinc.com

UMEX¹⁰⁰ Passive Sampler for Formaldehyde

Occupational and Indoor Air Exposure Monitoring

Sampling Rates for Other Aldehydes

Compound	Sampling Rate (ml/min)
Formaldehyde (full validation)	28.6 (velocity 5 to 100 cm/sec, 15 min to 24 hrs) 20.4 (velocity < 5 cm/sec, 1 to 7 days)
Acetaldehyde	22.8 [‡]
Benzaldehyde	13.5 [‡]
Butyraldehyde	15.8 [‡]
Crotonaldehyde	9.71 [‡]
Glutaraldehyde	14 [‡]
Hexanaldehyde	9.66 [‡]
Isovaleraldehyde	15.5 [‡]
Propionaldehyde	14 [‡]
Chloroacetaldehyde	19.4**
Decylaldehyde	10.4**
Heptanaldehyde	12.8**
Nonanaldehyde	11.6**
o-Phthaldehyde	12.83**
o-Tolualdehyde	12.7**
Valeraldehyde	15.4**

‡ Partial Validation

** Calculated sampling rate; see online Passive Sampling Guide at www.skinc.com

- Meets OSHA Method 1007 specifications
- Conforms to EU ISO 16000-4-2004
- Accuracy exceeds OSHA standards
- Highly selective 2,4-DNPH chemistry; easy analysis
- Documented formaldehyde uptake rates for 15-minute to 24-hour and 7-day samples
 - Sampling rates available for other aldehydes (see left)
- Samples low ppb levels of formaldehyde



Versatile UME^x 100 Sampler



Easy **personal formaldehyde sampling**
(15 minutes to 8 hours) — OSHA 1007



Convenient **indoor air formaldehyde sampling**
(24 hours or 7 days) with UME^x 100 and stand accessory

Tech Tips

► **Q: Why is my lab finding higher background levels of formaldehyde on sampling media than those reported by SKC?**

A: Page 3 of OSHA 1007 reports that storing samplers at elevated temperatures will cause DNPH to decompose. The decomposition product, 2,4-dinitroaniline, may be seen as formaldehyde by some labs if they are using a short/fast HPLC column with inadequate plate count. EPA TO-11A, Section 13.2.2 recommends an HPLC column efficiency of > 5000 theoretical plates. This column will allow for the effective separation of the formaldehyde peak from interfering peaks.



Description	Cat. No.	Price/Qty.
UMEX¹⁰⁰ Passive Sampler for Formaldehyde ** [†] Suitable for sampling other aldehydes	500-100	\$ 159.00/10
Treated Tape for QC - UME^x 100 [†]	500-100A	\$ 379.00/25
	P20084	\$ 35.00/50

Accessory	Cat. No.	Price/Qty.
Stand for Area Sampling	690-302	\$ 8.00/ea

* Limited shelf-life, single use only; do not reuse

† Store at ≤ 4 C (39.2 F)

Δ If sampling in an atmosphere containing formalin, see www.skinc.com/instructions/1795.pdf.

UMEX²⁰⁰ Passive Sampler for NO₂ and SO₂ Occupational Sampling and Near-road/Urban Air Monitoring

- ▶ Same chemistry as active OSHA Method ID-182
- ▶ Accurately measures exposures to sulfur dioxide and/or nitrogen dioxide from 15 minutes to 24 hours
- ▶ 3-week sample storage at ambient temperature
- ▶ Documented sampling rate of 17.3 ml/min for NO₂ and 15.2 ml/min for SO₂



Description	Cat. No.	Price/Qty.
UMEX²⁰⁰ Passive Sampler for Nitrogen Dioxide and/or Sulfur Dioxide*	500-200	\$ 159.00/10
Treated Tape for QC - UME ²⁰⁰ *	P20098	29.00/25

Accessory	Cat. No.	Price/Qty.
Stand for Area Sampling	690-302	\$ 8.00/ea

* Limited shelf-life, single use only; do not reuse



Personal SO₂/NO₂ sampling
(15 minutes to 8 hours)



Fenceline monitoring (up to 24 hours)
with UME²⁰⁰ and shelter

ABOUT

UMEX²⁰⁰ Sampler Applications

Occupational exposure monitoring in:

- Chemical plants
- Textile manufacturing
- Food industry
- Copper smelting
- Power plants
- Paper pulp mills
- Cement manufacturing
- Mines
- Welding
- Construction
- Fertilizer production
- Explosives production

UMEX²⁰⁰ is ideal for:

- Near-road monitoring
- Fenceline applications
- Urban air studies by community action groups

UMEX³⁰⁰ Passive Sampler for Ammonia Occupational Sampling and Fenceline/Odor Monitoring

- ▶ Chemistry similar to active OSHA Method ID-188 and NIOSH 6016
- ▶ Safe – no glass or sulfuric acid liquid in the sampler
- ▶ No particulate interference
- ▶ Enhanced sensitivity with documented 39.92 ml/min uptake rate
- ▶ Detects ammonia to:
 - 2.4 ppm for a 15-minute sample
 - 0.075 ppm for an 8-hour sample
 - 0.025 ppm for a 24-hour sample



Description	Cat. No.	Price/Qty.
UMEX³⁰⁰ Passive Sampler for Ammonia*†	500-300	\$ 169.00/10
Treated Tape for QC - UME ³⁰⁰ *†	P20083	39.00/25

Accessory	Cat. No.	Price/Qty.
Stand for Area Sampling	690-302	\$ 8.00/ea

* Limited shelf-life, single use only; do not reuse

† Store at ≤ 4 C (39.2 F)



Personal ammonia sampling
(15 minutes to 8 hours)



Fenceline monitoring (24 hours)
with UME³⁰⁰ and stand accessory

Standard of Good Practice

Store and prepare sampling media in solvent-free environments.

ABOUT

UMEX³⁰⁰ Sampler Applications

Ammonia is one of the most commonly produced industrial chemicals in the U.S and is found in the following industries:

- Agricultural (fertilizers, poultry, swine, dairy)
- Janitorial services (cleaners)
- Food and beverage (refrigeration and fermentation)
- Remediation
- Fuel
- Manufacturing (plastics, explosives, pesticides, textiles, dyes)

Tech Tips

► The 520 Elemental Mercury Passive Sampler only samples elemental mercury (Hg) in the vapor phase; it does not sample elemental Hg in the particulate phase or organic mercury compounds.



More Information

See information on extended sampling times and other data at www.osha.gov/dts/sltc/methods/inorganic/id140/id140bkr.html.

Elemental Mercury Passive Sampler For OSHA Method ID-140

- **Lowest cost per measurement available**
 - Reusable capsule holder
 - Replaceable sorbent capsule
- **Lightweight and easy to use; no pump needed**
- **No moisture or chlorine interferences**
- **Long-term sampling up to 120 hours**
- **Validated by OSHA ID-140**
- **High accuracy, sensitivity, and capacity**
 - Positive analysis of mercury
 - Removable sorbent capsule eliminates false high readings due to contamination of capsule holder



The SKC Elemental Mercury Passive Sampler measures worker exposure level as a time-weighted average (TWA) and permits positive analysis for mercury vapor. This economical and reliable passive sampler is designed for analysis by atomic absorption. The capsule holder can be cleaned and reused to reduce sampling costs.

Description	Cat. No.	Qty.
Sorbent Capsules contain Anasorb C300* and include replacement foams and resealable bags	520-02A	10
	520-02C	30
Reusable Capsule Holder	520-03	ea
	520-03A	5

* Anasorb C300 is equivalent to Carulite and Hydrar.

Note: To sample low levels of mercury, use a sorbent tube.

Hydrogen Cyanide Passive Sampler For OSHA Method 1015

- **More accurate than previous methods**
- **Lightweight miniature sampler for unobtrusive sampling**
- **Samples hydrogen cyanide from 0.44 to 20 ppm**
 - Suitable for 15-minute and 8-hour samples
- **Unique sampler design for direct transfer of sorbent into and out of the sampler**
 - Load and unload sorbent easily in the field
 - Sorbent transfers directly to vial for solvent extraction



SKC offers the Hydrogen Cyanide (HCN) Passive Sampler specified in OSHA 1015. The HCN Passive Sampler operates at a sampling rate of 28.4 ml/min and provides accurate HCN exposure results. The sampler design allows field loading of sorbent from vial to sampler housing before sampling and field transfer of sorbent from sampler to vial after sampling. Samples are extracted with water and analyzed by ion chromatography/electrochemical detector (IC/ELCHM).

Description	Cat. No.	Qty.
Hydrogen Cyanide Passive Sampler includes empty sampler housing and sealed glass vial of 600-mg soda lime sorbent	590-400	5

SKC Top Quality Filters



Filter	Features	Page
Mixed Cellulose Ester (MCE)	<ul style="list-style-type: none"> • Hydrophilic • Low metal background • Autoclavable • Biologically inert • Low artifact - dissolves/clears completely 	88
Silver	<ul style="list-style-type: none"> • Chemically inert • High temperature resistance and autoclavable • Uniform porosity and thickness • Bacteriostatic • Hydrostatic • Hydrophilic and inorganic 	91
Polycarbonate	<ul style="list-style-type: none"> • Smooth surface • Thin, transparent, and non-staining • Chemically resistant; biologically inert • Thermally stable • Hydrophobic • Exceptionally low tare weight 	91
Polyvinyl Chloride (PVC)	<ul style="list-style-type: none"> • Low tare weight • Very hydrophobic • Low ash 	93
Polytetrafluoroethylene (PTFE)	<ul style="list-style-type: none"> • Strong and resistant to acids, bases, and solvents • Hydrophobic • Low background • Low tare mass • Autoclavable 	94
Quartz	<ul style="list-style-type: none"> • Binder-free • Low metal background • Hydrophobic • Autoclavable • Heat treated 	95
Glass Fiber	<ul style="list-style-type: none"> • Binder-free • High temperature tolerance • Autoclavable • Hydrophobic • High particle retention and wet strength 	96
Cellulose	<ul style="list-style-type: none"> • 100% pure • Ashless • Autoclavable • Hydrophilic 	96
Gelatin	<ul style="list-style-type: none"> • Pre-sterilized by gamma irradiation • High moisture content • Water soluble - dissolves easily on agar • Suitable for bioaerosols 	100

See pages 106-107 for Size-selective Sampler Guide.

ABOUT

MCE Filters and Nanoparticles

NIOSH has been using the SKC Leland Legacy Sample Pump (pages 22-23) with 37-mm, 0.8- μm MCE filters in open-face cassettes for exposure assessments of engineered nanoparticles. Particles are analyzed for particle morphology and elemental mass. Note that nanoparticles will **not** fall through the pores of the 0.8- μm MCE filters; the very intense activity of nanoparticles and their constant collision with other particles prevent them from going through the pores like a sieve.

For more information, see page 71 of the Appendix in NIOSH Publication No. 2009-125, at www.cdc.gov/niosh/docs/2009-125/.



MCE Filters A Gold Standard for IH Sampling

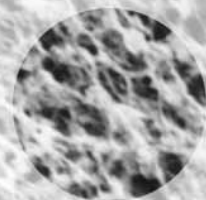

MCE Filters

Diameter (mm)	Pore Size (μm)	Support Pad [†]	Notes	Cat. No.	Qty.
13	5.0	No		225-8050	100
25	0.45	No		225-1911	100
25	0.8	Yes		225-19	100
25	0.8	No	use with IOM (p. 108)	225-1930	100
25	0.8	No	black grid	225-1913	100
25	1.2	No		225-1912 [†]	100
37	0.45	No		225-1914	100
37	0.45	Yes		225-9	100
37	0.8	No		225-1939	100
37	0.8	Yes		225-5	100
37	0.8	No	black grid	225-334	100
37	1.2	No		225-1923	100
37	5.0	No		225-1938	100
47	0.45	No		225-506	100
47	0.8	No		225-504	100
47	1.2	No		225-1921	100

[†] Recommended for use with the Button Sampler; see page 109

[‡] Filter supports available on page 103

Matched-weight MCE Filter Pairs (for User-loading)

Matched-weight MCE filter pairs are certified as matched in weight to within 50 μg . Load the filters into a cassette; the top filter collects the contaminant, the bottom filter acts as a control. No preweighing or conditioning is required. After sampling, both filters are weighed and the difference between weights is the sample weight.

Diameter (mm)	Filter Specifications	Cat. No.	Qty.
37	MCE, 0.8 μm , matched-weight within 50 μg , filter pairs only*	225-532*	50
47	MCE, 0.8 μm , matched-weight within 50 μg , filter pairs only*	225-531*	50

* Not preloaded in cassettes

Preloaded MCE Filters

All SKC preloaded filters include supports and are in SureSeal leak-free cassettes requiring a SureSeal Cassette Opener; see page 104.

Diameter (mm)	Filter Specifications	Cassette Description	Cat. No.	Qty.
25	MCE, 0.8 μm	3-pc clear plastic, banded	225-3100	50
25	MCE, 1.2 μm	3-pc black conductive, banded	225-507	50
37	MCE, 0.45 μm	3-pc black conductive, banded	225-1924	50
37	MCE, 0.45 μm	4-pc clear styrene, banded	225-1925	50
37	MCE, 0.8 μm	2-pc clear styrene, banded	225-508	50
37	MCE, 0.8 μm	3-pc clear styrene, banded	225-3-01	50
		3-pc clear styrene, not banded	225-3-01NB	50

Matched-weight MCE Filters Preloaded in Cassettes

All SKC preloaded filters include supports and are in SureSeal leak-free cassettes requiring a SureSeal Cassette Opener; see page 104.

Diameter (mm)	Filter Specifications	Cassette Description	Cat. No.	Qty.
25	MCE, 0.8 μm , matched-weight within 50 μg	2-pc clear styrene, banded	225-525	50
37	MCE, 0.8 μm , matched-weight within 100 μg	3-pc clear styrene, banded	225-3-02	50
37	MCE, 0.8 μm , matched-weight within 50 μg	2-pc clear styrene, banded	225-502	50
			225-527	12
37	MCE, 0.8 μm , matched-weight within 50 μg	3-pc clear styrene, banded	225-503	50
			225-528	12

Nano-Neat MCE Filter Cassettes

Ultra-pure for sampling workplace chromium. Cassettes are tinted purple for easy identification. Each box contains a Certificate of Conformance. All SKC preloaded filters include supports and are in SureSeal leak-free cassettes requiring a SureSeal Cassette Opener; see page 104.

Diameter (mm)	Filter Specifications	Cassette Description	Cat. No.	Qty.
25	MCE, 0.8 μm , Nano-Neat	2-pc purple styrene, banded	225-8402	50
25	MCE, 0.8 μm , Nano-Neat	3-pc purple styrene, banded	225-8404	50
37	MCE, 0.8 μm , Nano-Neat	2-pc purple styrene, banded	225-8408	50
37	MCE, 0.8 μm , Nano-Neat	3-pc purple styrene, banded	225-8410	50

Solu-CAP Cassette Inserts Capture the Entire Sample for Metals Analysis

- Eliminate need for lab to wipe or rinse cassette walls
- Meet NIOSH wall deposits requirement
- Ensure all collected sample is analyzed
- No assembly required
 - Supplied preloaded into 37-mm, 2-piece SKC cassette with support pad
- Digestible cellulose acetate dome on MCE filter contains entire sample
 - Completely soluble for analysis following NIOSH Method 7300 digestive procedure
 - Design specified in new NIOSH 7306
- Based on NIOSH research and publications
 - See References at below right



No Sample Losses!
100% of Sample is Contained in Domed Insert

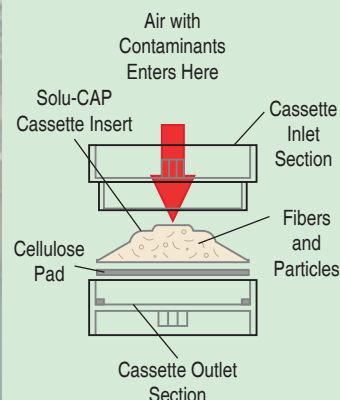

Eliminate sample loss from:

- ✗ Excessive filter loading during collection
- ✗ Filter transfer in the lab
- ✗ Cassette wall losses

Use Solu-CAP® preloaded cassette inserts to eliminate sample loss and meet NIOSH requirements for inclusion of all wall deposits. Solu-CAP's digestible cellulose acetate dome is sealed to a quality MCE filter. The user samples and sends the cassette to a laboratory. The lab removes the Solu-CAP insert, digests it in an acid solution per standard procedures, and performs analysis for airborne metals following published methods. **No sample loss!** The Solu-CAP design is specified in new NIOSH 7306.

Solu-CAP Applications

The following analytical methods contain options for including the non-filter deposits that Solu-CAP is designed to collect. *See second reference at right.*

- | | |
|--------------------------------------------------------------------------------------------------------------------------------------------------------------------------------------------------------------------------------------------------------------------------------------|---------------------------------------------------------------------------------------------------------------------------------------------------------------------------------------------------------------------------------------------------------------------------------------------------------------------------------|
| <ul style="list-style-type: none"> • NIOSH 7013 Aluminum • NIOSH 7020 Calcium • NIOSH 7024 Chromium • NIOSH 7027 Cobalt • NIOSH 7029 Copper • NIOSH 7030 Zinc • NIOSH 7046 Barium • NIOSH 7048 Cadmium | <ul style="list-style-type: none"> • NIOSH 7074 Tungsten • NIOSH 7102 Beryllium • NIOSH 7082 and 7105 Lead • NIOSH 7300, 7301, and 7303 Elements • NIOSH 7701 Lead • NIOSH 7704 Beryllium • NIOSH 7900 Arsenic • New - NIOSH 7306 Elements |
|--------------------------------------------------------------------------------------------------------------------------------------------------------------------------------------------------------------------------------------------------------------------------------------|---------------------------------------------------------------------------------------------------------------------------------------------------------------------------------------------------------------------------------------------------------------------------------------------------------------------------------|

Preloaded Solu-CAP Cassette Inserts

Description	Cat. No.	Qty.
Preloaded 37-mm Solu-CAP with cellulose acetate dome sealed to 0.8-µm MCE filter in 2-piece SKC cassette with support, requires a sample pump (pp. 8 and 14-21) and SureSeal Cassette Opener (p. 104)	225-8517	50



Perfect partners to Solu-CAP – AirChek TOUCH or XR5000 Sample Pump
see pages 8-10 or 14-15

References

Harper, M. and Ashley, K., "Acid-Soluble Internal Capsules for Closed-Face Cassette Elemental Sampling and Analysis of Workplace Air," *Jnl. of Occup. and Env. Hyg.*, 10:6, 297-306 (<http://doi.org/xj6>)

Ashley, K. and Harper, M., "Analytical Performance Issues: Closed-Face Filter Cassette (CFC) Sampling – Guidance on Procedure for Inclusion of Material Adhering to Internal Sampler Surfaces," *Jnl. of Occup. and Env. Hyg.*, 10:D29-D33 (<http://doi.org/wv3>)

ABOUT

The 5 Cs of Asbestos Cassettes

Only from SKC — BestChek® cassettes meet or exceed NIOSH, OSHA, and ASTM standards in Count, Clearing, Conductivity, Collection Area, and Construction.

Specify SKC BestChek Asbestos Cassettes — your assurance of reliability and accuracy.

For Preloaded Solu-CAPs see page 89



Microvacuum Cassettes for Asbestos

- Nozzle for easy sampling of settled dust on surfaces
- Meets specifications of ASTM Methods D5755 and D5756
- Use with personal sample pump at 2 L/min

Carbon-filled polypropylene with cowl and nozzle, BestChek 25-mm, 0.45-µm MCE filter for TEM analysis

Cat. No.225-322

Styrene (non-conductive) with nozzle, 37-mm, 0.45-µm MCE filter, for TEM analysis

Cat. No.225-9543

Certified BestChek Asbestos Cassettes The Highest Standard for Cassette Reliability

SKC Certified BestChek Filters in Carbon-filled Polypropylene Cassettes

All SKC preloaded asbestos filters include cellulose supports.

Diameter (mm)	Filter Specifications	Cassette Description	Cat. No.	Qty.
25	MCE, 0.8 µm	with cowl, banded	225-321	50
25	MCE, 0.8 µm	with cowl, banded, with stand-up plug in outlet end	225-321A	50
25	MCE, 0.8 µm, black grid	with cowl, banded	225-326	50
25	MCE, 1.2 µm, black grid	with cowl, banded	225-1934	50
25	MCE, 0.45 µm* TEM analysis	with cowl, banded, with support and 5.0-µm diffuser pad	225-327	50

* Available as microvacuum carpet cassette with nozzle; see below left

Asbestos Sampling Pumps

AirLite Personal Pump

Easy, Economical Asbestos Sampling

- Constant flows to 3000 ml/min
- Alkaline battery powered, over 10 hours run time
- Rugged
- Weighs only 340 grams (12 ounces)
- Simple operation with flow fault feature

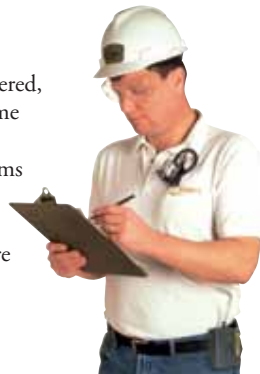

See details and ordering on page 29.

Flite 3 Area Pump

Programmable High Flow Asbestos Pump

- Flows from 2 to 20 L/min
- Battery or AC operation, long run times
- Robust steel casing with handle, 2.24 kg (4.9 pounds)
- Programmable with flow fault feature



See details and ordering on page 28.

QuickTake 30

Li-Ion Powered High Flow Asbestos Pump

- Constant flows from 10 to 30 L/min
- 9+ hours run time for asbestos clearance (see details on page 27)
- Tough, compact case with handle, 2.2 kg (4.8 pounds)
- Programmable with flow fault feature
- Low-noise battery-powered alternative to vacuum pumps



See details and ordering on pages 26-27.

Silver Membrane Filters Specified for X-ray Diffraction Analysis

- **Chemically inert, high temperature resistant**
 - Autoclave and reuse repeatedly without loss of performance
- **99.97% pure inorganic metallic silver**
- **Uniform porosity and thickness, smooth surface**
 - Ideal for NIOSH X-ray diffraction methods for crystalline silica, lead sulfide, boron carbide, and chrysotile asbestos
- **Hydrophilic and bacteriostatic**

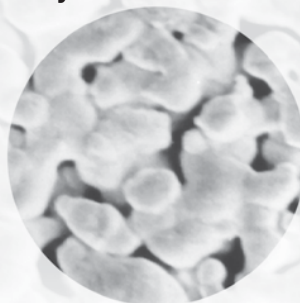

Diameter (mm)	Pore Size (µm)	Cat. No.	Qty.
25	0.8	225-1803	50
25	0.45	225-1802	50
37	0.8	225-1801	25
47	0.8	225-1804	25

Additional diameter and pore size silver membrane filters are available as a special order.

Polycarbonate Membrane Filters Ideal for Microscopy

- **Chemically resistant, thermally stable,[†] and strong**
- **Thin, transparent, non-staining, and smooth**
 - Ideal for light and electron microscopy
 - Exceptional background for sample observations
- **Hydrophobic, with exceptionally low tare weight**
- **Biologically inert**

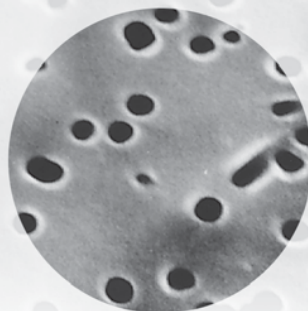

Diameter (mm)	Pore Size (µm)	Support Pad [‡]	Notes	Cat. No.	Qty.
25	0.4	No		225-1608	100
25	0.8	No	use with IOM (p. 108)	225-1601	100
37	0.4	No		225-1609	100
37	0.8	No		225-1602	100
47	0.4	No		225-1610	100
47	0.8	No		225-1603	100

[‡] Filter supports available on page 103

[†] Maximum operating temperature is 140 C (284 F).

Preloaded Polycarbonate Filters

All SKC preloaded filters include supports and are in SureSeal leak-free cassettes requiring a SureSeal Cassette Opener; see page 104.

Diameter (mm)	Pore Size (µm)	Support Pad	Cassette Description	Cat. No.	Qty.
25	0.8	Yes	3-piece conductive, with cowl, banded	225-1604	50

Microvacuum Cassette with Polycarbonate Filter

All SKC preloaded filters include supports and are in SureSeal leak-free cassettes requiring a SureSeal Cassette Opener; see page 104.

Diameter (mm)	Pore Size (µm)	Support Pad	Cassette Description	Cat. No.	Qty.
37	0.4	Yes	3-piece styrene (non-conductive) with nozzle; microvacuum*	225-9542*	ea

* Available in a Carpet Sampling Cassette Kit; see page 142



For size-selective samplers
see pages 106-117



For filter sampling
accessories
see pages 104-105

Tech Tips

- ▶ A typical filter has a rough side and a shiny side. The shiny side is easier to read under a microscope; expose the shiny side when collecting samples for microscopic analysis. The rough side holds dust more effectively; expose the rough side for gravimetric sampling.
- ▶ Filter pore size ratings are based on liquid filtration ratings. Filters will retain much smaller particles from air (e.g., a 0.8-µm liquid rated filter will retain > 50% of particles as small as 0.08 µm).



For sample pumps
see pages 8-9 and 14-23

Accu-CAP Cassette Inserts

Capture the Entire Sample for Gravimetric Analysis

- ▶ Meet specifications of new NIOSH Method 0501
- ▶ Ensure entire sample is captured and analyzed
- ▶ Fit inside a 37-mm, 2-piece SKC cassette with support pad
- ▶ Static-dissipative plastic dome on PVC filter contains entire sample
 - No cassette rinsing or wiping required
 - Prevents loss of sample during transport
 - No particles dislodged from filter during analysis preparation
- ▶ Ideal for sampling total dust (NIOSH 0500 and 0501) and carbon black (NIOSH 5000)

*For Support Pads
and Cassette Openers
see pages 103-104*

Use Accu-CAP® cassette inserts to meet NIOSH 0501 requirements for inclusion of all wall deposits in the sample. Accu-CAP features a static-dissipative plastic dome sealed to a quality PVC filter. The user preweighs the Accu-CAP, places it between the inlet and outlet sections of a two-piece 37-mm SKC-manufactured cassette with support pad, samples, removes Accu-CAP from the cassette, and postweighs it. **Accu-CAP effectively contains 100% of sampled particulate!**

Accu-CAP is Easy to Use



1 Prepare SKC 2-piece cassette with support pad.



2 Insert weighed Accu-CAP.



3 Complete cassette assembly. After sampling, remove Accu-CAP from cassette and weigh.

*SKC recommends using
AirChek Series Pumps
see pages 8-10, 14-15,
and 18-21*

References

Ashley, K. and Harper, M., "Analytical Performance Issues: Closed-Face Filter Cassette (CFC) Sampling – Guidance on Procedure for Inclusion of Material Adhering to Internal Sampler Surfaces," *Jnl. of Occup. and Env. Hyg.*, 10:D29-D33 (<http://doi.org/vv3>)

NIOSH Method 0501, www.cdc.gov/niosh/docs/2003-154/pdfs/0501.pdf

NIOSH Method 0501 Backup Report, www.cdc.gov/niosh/docs/2003-154/pdfs/bud/0501_5100_bud.pdf

Accu-CAP Cassette Inserts

Description	Cat. No.	Qty.
37-mm Accu-CAP with plastic dome sealed to 5.0-µm pore size PVC filter, requires 37-mm cassettes (p. 97), support pads (p. 103), a sample pump (pp. 8-10, 14-15, 18-21), and SureSeal Cassette Opener (p. 104)	225-8516GLA	60

GLA-5000 PVC Membrane Filters

► Suitable for multiple NIOSH/OSHA/ASTM air sampling methods

- Silica, metals, dust (total and respirable)
- Meet OSHA Method ID-215 (V.2) for hexavalent chromium

► Low tare weight and moisture pickup for gravimetric stability

- ≤ 0.5% after 24 hours at 48% RH and 50 C (122 F)

► Preloaded 25 and 37-mm cassettes available

- 25-mm cassettes are convenient for sampling inside a welding helmet (see About at far right)

► Available in Accu-CAP Cassette Inserts

► Both gravimetric and chemical analysis on the same filter using NIOSH 7300 or 7301 for metals (elements)

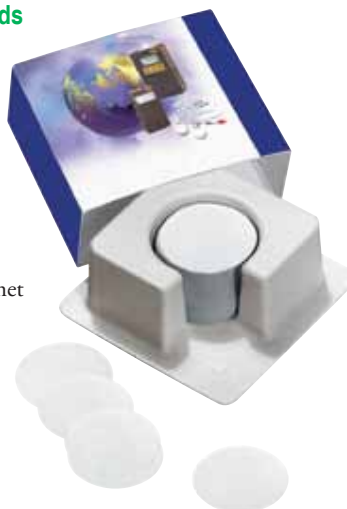

PVC Filters

Diameter (mm)	Pore Size (µm)	Support Pad†	Cat. No.	Qty.
25	5.0	No	225-5-25‡	100
37	5.0	Yes	225-5-37-P 225-80601K	100 1000
37	5.0	No	225-5-37	100
47	5.0	No	225-5-47	100

† Filter supports available on page 103

‡ Recommended for use with IOM and Button Samplers; see pages 108-109

Accu-CAP PVC Filter Inserts — see page 92

Clear plastic capsules heat-sealed to a filter; fit between parts of a two-piece SKC cassette with support pad; prevent cassette wall losses; ideal for gravimetric determinations for NIOSH 0500 and 5000

Diameter (mm)	Pore Size (µm)	Cat. No.	Qty.
37	5.0	225-8516GLA	60



Matched-weight PVC Filters

Diameter (mm)	Filter Specifications	Description	Cat. No.	Qty.
37	5.0 µm, matched-weight within 25 µg	Filter pairs only*	225-8222*	50
37	5.0 µm, matched-weight within 25 µg	2-piece clear styrene, banded	225-8201	50
37	5.0 µm, matched-weight within 25 µg	3-piece clear styrene, banded	225-8202	50

* Not preloaded in cassettes

Preloaded PVC Filters

All SKC preloaded filters include supports and are in SureSeal leak-free cassettes requiring a SureSeal Cassette Opener; see page 104.

Diameter (mm)	Filter Specifications	Cassette Description	Cat. No.	Qty.
25	5.0 µm	2-piece clear styrene, banded	225-8214	50
25	5.0 µm	3-piece clear styrene, banded	225-8215	50
37	5.0 µm	2-piece clear styrene, banded	225-802	50
37	5.0 µm	3-piece clear styrene, banded	225-803	50
37	5.0 µm, preweighed 5 decimal	2-piece clear styrene, banded	225-8204	12
			225-8205	100
37	5.0 µm, preweighed 5 decimal	3-piece clear styrene, banded	225-8208	12
			225-8209	100

ABOUT

PVC Cassette for Welding

Use 25-mm preloaded PVC filter Cat. No. 225-8214 or 225-8215 for sampling welder exposure to hexavalent chromium as specified in OSHA ID-215 (V.2). The smaller cassette fits more easily under a welder's helmet. For ultimate comfort, use the Helmet Adapter. See below.

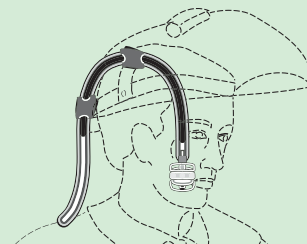

Helmet Adapter*

Ideal for welders or workers who wear a helmet with face shield. Effectively holds a filter cassette or sample tube in the breathing zone regardless of visor position.

Cat. No.225-600

* Developed in Canada by IRSST (Institut de recherche Robert-Sauvé en santé et en sécurité du travail du Québec)



For cassette blanks
see page 97

Tech Tips

- ▶ Back pressure on PTFE filters can vary within the same lot.
- ▶ Filter pore size ratings are based on liquid filtration ratings. Filters will retain much smaller particles from air (e.g., a 0.8- μm liquid rated filter will retain > 50% of particles as small as 0.08 μm).
- ▶ A typical laminated PTFE filter features two sides: the smooth membrane side and the rough laminate support side. The smooth side is easier to read under a microscope, therefore, expose the smooth membrane side to the air when collecting samples for microscopic analysis. The rough side holds dust more effectively, so expose the rough laminate support side for gravimetric sampling.



For size-selective samplers
see pages 108-117



For Sample Pumps
see pages 8-10 and 14-15

PTFE Membrane Filters

Aerosol Sampling in Aggressive Chemical Environments

- ▶ **Hydrophobic**
- ▶ **Low background for interference-free chemical determinations**
- ▶ **Strong and resistant to acids, bases, and solvents**
- ▶ **13-mm filter meets NIOSH Method 5517 specifications**
- ▶ **Low tare mass for accurate gravimetric analysis**
- ▶ **Temperature resistant to 260 C (500 F) — autoclavable**
- ▶ **Ideal for aerosol sampling, especially in environments also containing water vapor**

PTFE filters are the versatile choice for size-selective samplers. The material's unique properties make it ideal for gravimetric, chemical, and/or microscopic analysis of sample particulate. PTFE filters are used for aerosol sampling, air venting, and gas filtration.

PTFE Membrane Filters

Diameter (mm)	Pore Size (μm)	Support Pad [†]	Notes	Cat. No.	Qty.
13	5.0	No	unlaminated	225-17-03	100
25	0.5	No	with laminated PTFE support	225-2708	100
25	1.0	No	with laminated PTFE support	225-2714	100
25	2.0	No	with laminated PTFE support	225-2726	100
25	3.0	No	with PMP support ring	225-1711 [†]	50
25	5.0	No	unlaminated	225-1728	50
37	0.3	No	for <i>Anthrax</i> /SARS, laminated spun-bound polyester; see preloaded below	225-1722	100
37	0.45	Yes	on polypropylene support	225-17-04	100
37	1.0	Yes	on polypropylene support	225-17-01	100
37	1.0	Yes	with laminated PTFE support	225-2705	50
37	2.0	Yes	with laminated PTFE support	225-27-07	50
37	2.0	No	with PMP support ring	225-1709	50
37	5.0	Yes	unlaminated	225-17A	50
37	10.0	No	unlaminated	225-1729	100
47	0.5	No	with laminated PTFE support	225-2753	50
47	2.0	No	with PMP support ring	225-1747	50
47	2.0	No	with laminated PTFE support	225-2748	50
47	5.0	No	unlaminated	225-1724	100
47	60.0	No	unlaminated	225-1755	100

[†] Recommended for use with the Button Sampler; see page 109

[‡] Filter support pads available on page 103

Preloaded PTFE Membrane Filters

All SKC preloaded filters include supports and are in SureSeal leak-free cassettes requiring a SureSeal Cassette Opener; see page 104.

Diameter (mm)	Filter Specifications	Cassette Description/Notes	Cat. No.	Qty.
25	PTFE, 1.0 μm , with laminated polypropylene support pad	2-piece black conductive, goblet style	225-1725	50
37	PTFE, 0.3 μm , laminated with spun-bound polyester with cellulose support; for <i>Anthrax</i> /SARS	3-piece clear styrene, banded	225-1723	50
37	PTFE, 1.0 μm , with cellulose support	3-piece clear styrene, banded	225-1715	50
37	PTFE, 2.0 μm , with cellulose ring	2-piece opaque plastic, banded	225-1713	50

Diesel Particulate Matter Cassettes Suitable for DPM and Carbon Nanotubes and Fibers

DPM Cassette — Preloaded Quartz Filters with Submicron Impactor

- Meets NIOSH Method 5040 specifications
- Preloaded in specially designed cassette with internal size-selective impactor
 - Screens particles ≥ 1 micron
 - Contains two quartz filters: one for sample collection and one for dynamic blank
- Use for elemental carbon analysis of DPM (NIOSH 5040) or for carbon nanotubes and carbon nanofibers (NIOSH CIB 65, www.cdc.gov/niosh/docs/2013-145)



Diameter (mm)	Filter Specifications	Cassette Description	Notes	Cat. No.	Qty.
37	2 heat-treated quartz*	1 piece with impactor, tamper-evident sealed, single use†	NIOSH 5040 analysis, average sample deposition area is 8.04 cm ²	225-317	10

* Limited shelf-life † Requires 1/4-inch ID tubing or Filter Cassette/Cyclone Holder; see p. 104

Preloaded Quartz Filters Without Submicron Impactor

- An economical choice when no interfering respirable dusts are present
- Meets NIOSH 5040 specifications
- Preloaded into standard 37-mm, 3-piece clear styrene cassette



All SKC preloaded filters include supports and are in SureSeal leak-free cassettes requiring a SureSeal Cassette Opener; see page 104.

Dia. (mm)	Filter Specifications	Cassette Description	Notes	Cat. No.	Qty.
25	Heat-treated Tissuquartz, support pad	3-piece clear styrene, banded	Meets NIOSH NEAT 2.0 protocol for NIOSH 5040 analysis	225-401-25	50
37	Heat-treated quartz, support pad	3-piece clear styrene, banded	NIOSH 5040	225-401	50

Quartz Depth Filters

For Elemental/Organic Carbon, DPM, and Trace-level Contaminants

Quartz Filters

- Heat treated to reduce trace organics
- Binder free
- Low metal background

Diameter (mm)	Description	Cat. No.	Qty.
25	Type R-100	225-1824 [#]	100
25	Tissuquartz	225-1825 [¥]	100
37	Tissuquartz	225-1822 [¥]	25
37	Type R-100	225-1827 [#]	100
47	Tissuquartz	225-1823 [¥]	25
47	Tissuquartz	225-1811 [¥]	100
47	Type R-100	225-1830 [#]	100
102	QM-A	225-1808 [†]	100

[#] 380 μ m thick [¥] 432 μ m thick [†] 450 μ m thick

Tech Tips

DPM Cassettes and Cyclones

► Use a cyclone with the DPM Cassette in environments where it is necessary to scrub out large non-respirable particles that could quickly clog the impactor plate inside the cassette. Any cyclone that can be attached securely to the DPM Cassette can be used. However, the SKC GS-1 Cyclone is equivalent to the 10-mm nylon cyclone used by U.S. federal compliance officers at this time.



DPM Cassette shown with GS-1 Cyclone Cat. No. 225-105 in holder Cat. No. 225-1 See page 110

ABOUT

Quartz Depth Filters

Q: What is the difference between Type R-100 and Tissuquartz depth filters?

A: Type R-100 filters meet NIOSH requirements: 99.97% retention efficiency for 0.3- μ m dioctylphthalate (DOP) particles up to a 200-mg filter loading.

Tissuquartz has a typical retention efficiency of 99.90% for 0.3- μ m DOP particles at 32 L/min per 100 cm² filter media.

Glass Fiber Depth Filters

ABOUT

Depth Filter Pore Size Rating

The pore size rating for depth filters is commonly termed “nominal” or approximate. This is due to the method for determining pore size. Depth filters are made of intertwined fibers or sintered particles. These form irregular openings through which air passes, but most particles do not. Pore size testing for depth filters is usually achieved by passing liquid containing particles of a known size through the filter. If an acceptable number of particles are trapped, that particle size becomes the “liquid nominal,” which is typically stated as, “Filter removes > xx% of particles $\geq x \mu\text{m}$.”

- ▶ High-temperature tolerant — autoclavable
- ▶ Chemical and pH resistant; biologically inert
- ▶ Liquid nominal pore size of 1.0 μm
- ▶ High particle retention
- ▶ Made of binder-free borosilicate glass fiber for purity
- ▶ Available with binder for excellent wet strength, easier handling, and filter integrity

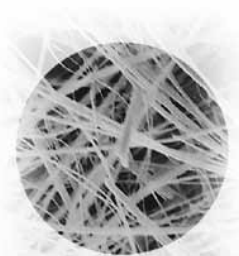

Ideal for gravimetric analysis

SKC quality Glass Fiber Depth Filters are used where high flow rate and micron/submicron filtration is required. Glass Fiber Filters are suitable for both liquid and air filtration. Select from binder-free filters for purity that is ideal for analytical and gravimetric determinations or filters with binder for strength in long-duration, high-pressure, or wet applications.

Dia. (mm)	Pore Size (μm) ^Δ	Description	Cat. No.	Qty.
13	1.0	binder free, A/E	225-16	500
25	1.0	binder free, A/E	225-702 [†]	500
25	1.0	acrylic binder, 50 ml thick	225-703	100
25	1.6	binder free, GF/A	225-58F	100
37	1.0	binder free, A/E	225-7	500
37	1.0	binder free, A/B	225-701	100
37	—	PTFE coated	225-705	100
47	1.0	binder free, A/E	225-7047	100
			225-714	500
90	1.0	Ultra pure	225-712	25
8 x 10 inches	1.0	binder free, A/E	225-7-07	100

^Δ Liquid nominal (see About at above left)

[†] Recommended for use with IOM and Button Samplers; see pages 108-109

ABOUT

Glass Fiber Filter Types

Type A/E Glass Fiber

- For gravimetric analysis of air pollutants and testing dissolved/suspended wastewater solids
- High flow rates, wet strength, and dirt (solids) holding capacities

Type A/B Glass Fiber

- High dirt-loading capacity with thicker glass
- Manufactured of the highest quality borosilicate glass microfibers

Preloaded Glass Fiber Filters

All SKC preloaded filters include supports and are in SureSeal leak-free cassettes requiring a SureSeal Cassette Opener; see page 104.

Dia. (mm)	Filter Specifications	Cassette Description	Cat. No.	Qty.
37	Glass fiber, A/E, 1.0 μm , ^Δ cellulose support	2-piece clear plastic, banded	225-709	50
37	Glass fiber, A/E, 1.0 μm , ^Δ cellulose support	3-piece clear plastic, banded	225-706	50

^Δ Liquid nominal; see About at above left











Cellulose Depth Filters









- ▶ Ideal for gravimetric sampling methods
- ▶ 100% pure, ashless cellulose fiber
 - Type 40: ashless, quantitative
 - Type 4: qualitative

Dia. (mm)	Pore Size (μm)	Description	Cat. No.	Qty.
37	—	Type 40	225-18A	500
		Type 4	225-18B	500

SureSeal Cassette Blanks Certified Leak-free

All SureSeal cassettes are inspected to meet a **vacuum leak test** of < 1 inch Hg decay per 30 seconds when subjected to 24 inches Hg vacuum, and a pressure decay of < 1 psi per 30 seconds when subjected to 5 psi pressure. *Require the use of a SureSeal Cassette Opener; see page 104*

Diameter (mm)	Description	Cat. No.	Qty.	
25		2 piece, standard;	225-2-25LF	50
		styrene, clear	225-2258	100
25		3 piece, standard;	225-3-25LF	50
		styrene, clear	225-2259	100
25		Middle ring only;	225-300R	50
		styrene, clear, 1/2 inch		
25		2 piece, goblet style;	225-8481	50
		polypropylene,		
		opaque white;		
		solvent-resistant ^Δ		
25		3 piece, goblet style;	225-8585	50
		polypropylene,		
		opaque white;		
		solvent-resistant ^Δ		
25		2 piece, goblet;	225-2257	50
		polypropylene,		
		conductive black		
25		3 piece,	225-3-23	50
		2-inch middle cowl;		
		polypropylene,		
		conductive black		
25		3 piece,	225-329	50
		1/2-inch middle ring;		
		polypropylene,		
		conductive black		
37		2 piece, standard;	225-2LF	10
		styrene, clear	225-2050LF	50
			225-2250	250
37		3 piece, standard;	225-3LF	10
		styrene, clear	225-3050LF	50
			225-3250	250

Diameter (mm)	Description	Cat. No.	Qty.	
37		Middle ring only;	225-304	50
		styrene, clear, 1/2 inch		
37		2 piece, standard;	225-4	50
		styrene,		
		opaque brown		
37		3 piece, standard;	225-8451	50
		styrene,		
		opaque brown		
37		2 piece, standard;	225-8483	50
		polypropylene,		
		opaque white;		
		solvent-resistant ^Δ		
37		3 piece, standard;	225-45	10
		polypropylene,	225-45A	50
		opaque white;		
		solvent-resistant ^Δ		
37		2 piece, standard;	225-308	50
		polypropylene,		
		conductive black		
37		3 piece, standard;	225-309	50
		polypropylene,		
		conductive black		
		<i>Static free – ideal for cyclones!</i>		
47		2 piece, standard;	225-8496	16
		polypropylene,		
		conductive black		
47		3 piece, standard;	225-8497	16
		polypropylene,		
		conductive black		

^Δ Compatible with most solvents; for a solvent compatibility list, visit www.skinc.com or contact SKC

Standard of Good Practice

Minimize cassette wall losses during sampling with a cyclone. NIOSH suggests the use of a static-dissipative (conductive) black polypropylene filter cassette such as Cat. No. 225-309. Ashley, K., Harper, M., *Journal of Occupational and Environmental Hygiene* 10:3, 2013, pp. D29-D33, <http://doi.org/wv3>



Coated Filter Selection Guide

Tech Tips

Coated Filters for Diisocyanates

► While meeting the specifications of OSHA Methods 42 and 47, Coated Filter Cat. No. 225-9002 contains a higher than specified loading of reagent to increase stability and shelf-life. Coated Filter Cat. No. 225-9002 traps both vapor and aerosol phases. SKC also offers Coated Filter Cat. No. 225-9013 that contains the specified reagent loading for OSHA 42 and 47 but has a freezer shelf-life of only three months.

ISO-CHEK

Isocyanate Sampling System

See page 115 for details.

Chemical	Method [∞]	Preloaded Filter; Coating (in 37-mm cassettes)	Cat. No.*	Qty.
Acetic anhydride	OSHA 82	2 Glass filters; 1-(2-pyridyl) piperazine §	225-9009 §	10
Acetic anhydride	OSHA 102	2 Glass filters; veratrylamine and di-n-octyl phthalate	225-9010 †	10
4-Aminobiphenyl	OSHA 93	2 Glass filters; sulfuric acid	225-9004	10
Aniline	NIOSH 2017 ‡	2 Glass filters; sulfuric acid	225-9004 ‡	10
Arsenic, volatile compounds	OSHA ID-105	1 MCE filter and cellulose pad; sodium carbonate	225-9001	10
Benzidine	OSHA 65	2 Glass filters; sulfuric acid	225-9004	10
Bromine, chlorine	NIOSH 6011	1 25-mm PTFE pre-filter and polypropylene support; 1 25-mm specially cleaned silver membrane and polypropylene support (in 25-mm cassette)	225-9006	5
Crotonaldehyde	OSHA 81	2 Glass filters; 2,4-dinitrophenylhydrazine and phosphoric acids §	225-9019 §	10
o-Dianisidine	OSHA 71	2 Glass filters; sulfuric acid	225-9004	10
3,3'-Dichlorobenzidine	OSHA 65	2 Glass filters; sulfuric acid	225-9004	10
Diisocyanates (HDI; 2,6-TDI; 2,4-TDI)	ASTM D5836 Δ OSHA 42 ‡	1 Glass filter and cellulose support; 1-(2-pyridyl)piperazine ‡§	225-9013 † 225-9002 ‡§	10 10
Diphenylamine	OSHA 78	2 Glass filters; sulfuric acid	225-9004	10
Fluorides	OSHA ID-110 NIOSH 7902 ASTM D4765	1 MCE filter and cellulose pad; sodium carbonate	225-9001 #	10
Fluorides, particulate	NIOSH 7906	2 Nitrocellulose filters; 1 coated with sodium carbonate, 1 uncoated	225-9031	10
Glutaraldehyde	OSHA 64	2 Glass filters; 2,4-dinitrophenylhydrazine and phosphoric acid §	225-9003 §	10
Hydrazine	OSHA 108	2 Glass filters; sulfuric acid	225-9012	10
Hydrofluoric acid	NIOSH 7906	2 Nitrocellulose filters; 1 coated with sodium carbonate, 1 uncoated	225-9031	10
Hydrogen bromide	NIOSH 7907	2 Quartz filters; 1 coated with sodium carbonate, 1 uncoated	225-9032	10
Hydrogen chloride	NIOSH 7907	2 Quartz filters; 1 coated with sodium carbonate, 1 uncoated	225-9032	10
Hydrogen peroxide	OSHA 1019/ NON 57*	2 25-mm Quartz filters; titanium oxysulfate hydrate (in 25-mm cassette)	225-9030 •	10
Isocyanates	ASTM Σ	1 PTFE filter; 1 glass filter impregnated with MAMA (ISO-CHEK Sampling System, see p. 99)	225-9022 Σ 225-9022A Σ	12 36
Isocyanates (HDI; 2,6-TDI; 2,4-TDI)	ASTM D5836 Δ OSHA 42 ‡	1 Glass filter and cellulose support; 1-(2-pyridyl)piperazine ‡§	225-9013 † 225-9002 ‡§	10 10
Isocyanates (HDI, MDI, TDI, IPDI, HDI-BT, HDI-IC)	OR-OSHA 1010 ▼	1 13-mm Glass filter; MAMA (in 13-mm Swinnex holder) §	225-9029 § ▼	5
Isocyanates, organic	MDHS 25/3 (U.K.)	1 25-mm A/E glass filter; methoxyphenyl piperazine ◊§	Special order	5
n-Isopropylaniline	OSHA 78	2 Glass filters; sulfuric acid	225-9004	10
Maleic anhydride	OSHA 86	2 Glass filters; veratrylamine §	225-9021 §	10
Maleic anhydride	■	1 25-mm Glass filter; veratrylamine ◊§	225-9028 ◊§	10
Mercaptans (methyl-, ethyl-, n-butyl-, phenyl-)	NIOSH 2542 OSHA 26	1 Glass filter; mercuric acetate §	225-9007 §	10
4,4'-Methylene bis (2-chloroaniline) (MOCA)	OSHA 71	2 Glass filters; sulfuric acid	225-9004	10
Methylene bisphenyl (MDI)	OSHA 47 ‡	1 Glass filter and cellulose support; 1-(2-pyridyl)piperazine ‡§	225-9013 † 225-9002 ‡§	10 10
4,4'-Methylenedianiline	OSHA 57 Ω NIOSH 5029	2 Glass filters; sulfuric acid	225-9004	10
1-Naphthylamine, 2-naphthylamine	OSHA 93	2 Glass filters; sulfuric acid	225-9004	10
Nitric acid	NIOSH 7907	2 Quartz filters; 1 coated with sodium carbonate, 1 uncoated	225-9032	10
Nitrobenzene	NIOSH 2017 ‡	2 Glass filters; sulfuric acid	225-9004 ‡	10
Ozone	OSHA ID-214	2 Glass filters; nitrite-impregnated §	225-9014 §	10
Phenylenediamine (o-, m-, p-)	OSHA 87	2 Glass filters; sulfuric acid	225-9004	10
Phosphine	OSHA 1003	1 Glass filter; 1 polyester filter coated with mercuric chloride §	225-9018 †§	10
Phosphoric acid	NIOSH 7908	1 Quartz filter ▲	225-9033	10
Sulfur dioxide	NIOSH 6004 (modified)	1 MCE pre-filter and support/1 cellulose filter and support; sodium carbonate	225-9005	10
Sulfuric acid	NIOSH 7908	1 Quartz filter ▲	225-9033	10
2,4-Toluenediamine	OSHA 65	2 Glass filters; sulfuric acid	225-9004	10
2,6-Toluenediamine	OSHA 65	2 Glass filters; sulfuric acid	225-9004	10
o-Tolidine	OSHA 71	2 Glass filters; sulfuric acid	225-9004	10
o-Toluidine	NIOSH 2017 ‡	2 Glass filters; sulfuric acid	225-9004 ‡	10
Toluidine (o-, m-, p-)	OSHA 73	2 Glass filters; sulfuric acid	225-9004	10
1,3,5-Triglycidyl isocyanurate (TGI)	OSHA PV2055	1 Glass filter; hydrobromic acid	225-9027	10
Valeraldehyde	OSHA 85	3 Glass filters; 2,4-dinitrophenylhydrazine and phosphoric acid §	225-9020 §	10
m-Xylenediamine (m-XDA, p-XDA)	OSHA 105	2 Glass filters; sulfuric acid	225-9004	10

* Coated filters have a limited shelf-life.

† Custom order due to very limited shelf-life

Δ ASTM D5836 and D5932 for 2,4-TDI, 2,6-TDI only

◊ Filters only; not preloaded in cassettes

§ Storage below 4 C (39.2 F) required

‡ Also requires Sorbent Tube Cat. No. 226-15, see page 38

Ω OSHA 57 is an update of NIOSH 5029, which called for a single filter.

‡ See Tech Tips above.

Collects both vapor and aerosol phases of fluorides. Patented in Canada by IRSST (Institut de recherche Robert-Sauvé en santé et en sécurité du travail du Québec), Canada Patent No. 1,299,114

Σ Meets multiple ASTM methods, see page 99

∞ The methods listed are the most widely used. Additional methods may be listed in the Sampling Guide. See pages 143-211.

• Also requires Sorbent Tube Cat. No. 226-193-UC or 226-199-UC for simultaneous, separate sampling of peracetic acid; see page 42

▼ Also requires Impinger Cat. No. 225-36-1, see page 67

■ For inhalable TLV; analysis by OSHA 86

▲ A coated filter is not needed for this method, as sulfuric acid and phosphoric acid are non-volatile acids and are present in the air as an aerosol.

ISO-CHEK

Simultaneous and Separate Collection of Isocyanate Phases

- ▶ **Accurately samples diisocyanates: HDI, MDI, IPDI, HMDI, 2,4-TDI, and 2,6-TDI**
- ▶ **Meets the specifications of several methods**
 - ASTM D5932 for 2,4 and 2,6-TDI
 - ASTM D6561 for HDI
 - ASTM D6562 for HDI
- ▶ **The only filter-based system that simultaneously traps and separates both monomers and oligomers**
 - For better determinations of control strategies
- ▶ **Decreases sample preparation and analysis time by 40% compared to other methods**
 - Premade calibration standards are available
- ▶ **Highly stable — low temperature storage and transport not required**
- ▶ **Highly sensitive analysis provides detection limits below current regulated exposure levels**
 - Ideal for occupational sampling and environmental surveys
 - Requires only a 15-minute sample time
- ▶ **Round-robin proficiency testing for ISO-CHEK labs ensures accurate, consistent analysis**
 - Search “laboratories” at www.skcinc.com

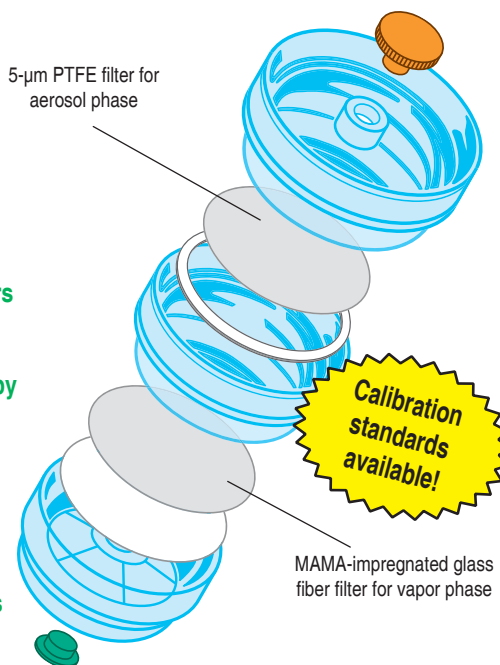

Exploded view of ISO-CHEK Filter Cassette (Cassette in image is tinted for clarification.)

the ISO-CHEK Advantage!

- ✔ **Simultaneous collection and separation of phases at the point of collection**
Less time-consuming and more accurate analysis of each phase
- ✔ **Reagent is stable at room temperature.**
- ✔ **1 L/min flow efficiently captures aerosol phase isocyanates compared to denuder collectors.**
- ✔ **No handling precautions**
No broken glass or splashing impinger liquid

ABOUT

ISO-CHEK Development
ISO-CHEK was developed and patented by IRSST (Institut de recherche Robert-Sauvé en santé et en sécurité du travail du Québec).

For ISO-CHEK analytical laboratories
www.skcinc.com
Search “laboratories”

Description	Cat. No.	Qty.
ISO-CHEK Sampling System with Derivatizing Reagent,*† preloaded clear cassettes and jars of Derivatizing Solution (MOPIP in toluene)	225-9023	4
	225-9023A	10
ISO-CHEK Sampling Cassettes,* preloaded clear cassettes for isocyanates, requires Derivatizing Solution; see below	225-9022	12
	225-9022A	36

Accessories	Cat. No.	Qty.
Derivatizing Solution,** 5 ml of MOPIP in toluene, in jars	225-9050	12
Jars, 37 mm with PTFE-lined cap	225-8377	36
Calibration Standard,‡ MAMA-HDI, 1 gram	225-9053	ea
Calibration Standard,‡ MAMA-HMDI, 1 gram	225-9056	ea
Calibration Standard,‡ MAMA-IPDI, 1 gram	225-9054	ea
Calibration Standard,‡ MAMA-MDI, 1 gram	225-9062	ea
Calibration Standard,‡ MAMA-2,4-TDI and 2,6-TDI, 1 gram	225-9052	ea
Calibration Standard Set,‡ HDI, MDI, IPDI, 2,4-TDI, 2,6-TDI, 1 gram each	225-9055	set
Packaging Kit, materials for shipping 10 packages of 10 samplers and jars	225-9059	ea

* Limited shelf-life

† Hazmat shipping charges for air shipments only, ground shipments exempt

‡ Limited shelf-life, freezer storage recommended; refrigerated shipping not required

U.S. Patent No. 4,961,916; see About at above right

ABOUT

Why Use Gelatin Filters?

Sampling microbes with traditional filter materials has been known to reduce culturability due to desiccation of the microbes. The high-moisture content of gelatin filters helps to maintain microorganism viability for sampling periods up to 30 minutes. In addition, studies with T3 viruses have shown gelatin filters to be the most suitable for sampling viruses (low passage and high detection sensitivity) due to their complete solubility.

Reference

Haferkorn, R., et al., "Comparative Studies on Detection Methods for Bacteriophages in Aerosols and on the Retentive Capability of Filters and Impingers for Bacteriophage Aerosols," Arch. Hyg., Munich 152, 1968, pp. 97-106

Gelatin Filters

Maintain Viability of Collected Microorganisms

- **Absolute retention rate**
 - 99.9995% for *Bacillus subtilis var. niger* spores[†]
 - 99.94% for T3 phages (coli phages)[‡]
 - 99.9% T1 phages (coli phages)[‡]
- **High moisture content**
 - Maintain microbe viability for short sampling periods
- **Completely water soluble**
 - Dissolve easily when placed on agar
 - Provide the solubility required for virus sampling
- **Pre-sterilized by gamma irradiation**
- **Ideal for monitoring in pharmaceutical plants**
- **Can be used to monitor in areas where disinfectants or antibiotics are present**



The unique properties of gelatin filters provide unequalled bacteria retention levels for quantitative analysis. Sampling with gelatin filters is easy, efficient, and can provide information about relative changes in microorganism concentration throughout the day. Gelatin filters dissolve easily when placed on agar, allowing for a gentle transition from sample medium to growth medium. **For maximum culturability and superior collection of inhalable-size bioaerosols, combine 25-mm gelatin filters with the SKC Button Sampler, see below.**

Dia. (mm)	Support Pad	Notes	Cat. No.	Qty.
25	No	water soluble	225-9551 ^{†*}	50
37	No	water soluble	225-9552 [*]	50

[†] Recommended for use with IOM and Button Samplers; see pages 108-109

^{*} Limited shelf-life; storage at 4 to 8 C (39.2 to 46.4 F) recommended. Avoid temperatures < 4 C (39.2 F), moisture, and chemical vapors.

[‡] At inlet velocities of 0.25 m/s, 0.3 m/s (80% RH), and 0.3 m/s (50% RH), respectively

Gelatin Filters with the Button Sampler Autoclavable Inhalable Sampler

The sterile, high-moisture properties of gelatin filters combine with the unique features of the Button Sampler for maximum microorganism survivability and superior collection of inhalable-size bioaerosols. The autoclavable Button Sampler's unique inlet contains evenly spaced holes that act as sampling orifices for multi-directional sampling. The proximity of the gelatin filter to the inlet minimizes transmission losses and provides for equal distribution of particles and low intersample variation for viable and non-viable analyses. **For more information on the Button Sampler, see page 109.**



For sample pumps
see pages 8-10 and 14-15

Description	Cat. No.
Button Sampler Pump Kit includes Button Sampler, standard AirChek XR5000 Sample Pump, single charger, 0.9 meter (3 feet) of Tygon tubing, and calibration adapter, <i>requires a 25-mm filter</i>	100-240 V 210-4121

VersaTrap Spore Trap Cassette

Traps Smaller Mold Spores Using Higher Flows

- ▶ **High collection efficiency from 5 to 30 L/min**
 - VersaTrap captures *Aspergillus* and *Penicillium* mold spores as small as 1.5 µm at 30 L/min
- ▶ **A standard collection method for mold spore count and genus identification**
- ▶ **Easy analysis — ASTM Method D7391-09**
 - Positioning notches and flat edges provide for easy alignment on microscope stage
 - Uniform, well-defined rectangular deposition
- ▶ **Optimized slide adhesive**
 - Optically clear and tested for superior adhesion
- ▶ **SureSeal certified leak-free cassettes for sample integrity**
- ▶ **Unique serial number on each cassette for sample traceability**



VersaTrap® spore trap cassettes provide sampling versatility needed to capture mold spores and other particles ranging from 1.5 to 3.9 µm. Sampling is as easy as selecting the flow rate that will target the desired particle size (see table below), calibrating a pump to the flow rate, and collecting the sample.

VersaTrap Design

The narrow slit inlet focuses particles toward the clear glass slide that is coated with a fully optimized sticky substrate. Targeted size particles are effectively held in a well-defined rectangular footprint. Each slide is encased in a SureSeal certified leak-free cassette to ensure sample integrity.

VersaTrap Makes Analysis Easy

- Slides easily removed from the cassette
- Positioning notches and flat edges for fast, easy alignment
- Well-defined rectangular footprint for accurate analysis using standard equipment
- Unique serial numbers for sample traceability

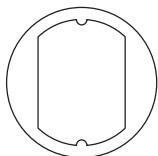

High Flows + Low Cut-points + No Particle Bounce =
High Collection Efficiency

Flow Rate (L/min)	VersaTrap 50% Cut-point (µm)
30	1.5
25	1.7
20	1.9
15	2.3
10	2.8
5	3.9

Description	Cat. No.	Qty.
VersaTrap Spore Trap Cassettes, 37 mm, limited shelf-life	225-9820	10
	225-9821	50
VersaTrap Wall Adapters, for sampling in wall cavities	225-9822	5

For a list of microbiological laboratories, go to www.skinc.com/catalog/infopage.php?id=6000.

the VersaTrap Advantage!

- ✔ **Uniform particle deposition**
Uniform rectangular deposition provides for accurate analysis using standard equipment.
- ✔ **High collection efficiency at flows between 5 and 30 L/min**
Target specific size particles for true versatility. See table below left for more information.
- ✔ **Unique serial numbering for sample traceability**
- ✔ **Positioning notches and flat edges on slide**
Fast, easy alignment on microscope stage

Tech Tips

- ▶ VersaTrap cassettes can be operated at 30 L/min to trap the smallest *Penicillium/Aspergillus* spores that other spore traps do not. VersaTrap provides a 150-liter sample at 30 L/min in only 5 minutes.

QuickTake 30 Pump Ideal for Spore Traps

see pages 26-27



More Information

- Visit www.skinc.com and search "1649."
- See www.astm.org for spore trap analysis method ASTM D7391-09.

www.skinc.com

Filter Sampling Accessories

Cassette/Filter Holders

Cassette and Filter Holders

SKC Filter Cassette Holder — Reinforced to Prevent Tube Kinking

The lightweight SKC Filter Cassette Holder attaches firmly to the collar for sampling in the breathing zone. Its special design securely holds a two or three-piece 37-mm cassette with or without cyclone, 25-mm cassette with cowl, or DPM Cassette with GS-1 Cyclone. The Filter Cassette Holder includes 0.9 meter (3 feet) of 1/4-inch ID Tygon tubing and a 25-mm adapter ring (cassette in photo **not** included).



Cat. No.225-1



Specialty Filter Holders

13-mm Swinnex

- 2-section polypropylene with silicone seal
- Reusable
- Autoclavable with filter in place
- Specified in NIOSH Method 5503 for PCBs



Cat. No. 225-32..... pk/10

Replacement silicone gaskets

Cat. No. 225-3201..... pk/100

25-mm Delrin - In Line

- 2 sections, in line with stainless steel support
- Broad chemical compatibility and strength
- Useful for low pressure applications



Cat. No. 225-1109..... pk/6

25-mm Delrin - Open-face

- Open-face with stainless steel support
- Lightweight and corrosion-resistant
- Includes 1/4-inch ID hose barb adapter



Cat. No. 225-1107..... pk/6

47-mm Polycarbonate

- Lightweight polycarbonate is ideal for air monitoring applications
- Opens and closes easily without disturbing the filter
- Autoclavable



Cat. No. 225-4702.....ea

47-mm Savillex PFA

- Includes 1/4-inch ferrule nuts and wrench set
- Replace filters without disconnecting lines
- Operate at -200 to 260 C (-328 to 500 F)



Cat. No. 225-1712.....ea

47-mm Polypropylene

- Ideal for vacuum and pressure air sampling applications
- Can be used with pressures up to 100 psig



Cat. No. 225-1147.....ea



More Information

See Pump Calibration and Sampling with Filters and Cyclones videos at www.skinc.com/catalog/infopage.php?id=9080

Filter Supports

Various materials are used to support filters during sampling. Cellulose support pads feature a smooth surface and uniform airflow distribution. Porous plastic pads are impervious to most solvents. Use stainless steel screens when cellulose or plastic will interfere with analysis.

Diameter (mm)	Support Material	Cat. No.	Qty.
25	Cellulose pad	225-28	100
25	Stainless steel screen, wide mesh	225-2625	ea
25	Polypropylene pad (porous plastic)	225-2901	100
37	Cellulose pad	225-27	100
		225-2700	500
37	Cellulose spacer ring	225-23	25
37	Polypropylene pad (porous plastic)	225-2902	100
37	Stainless steel screen, wide mesh	225-26	ea
37	Stainless steel screen, fine mesh	225-2637	ea
47	Cellulose pad	225-2903	100
47	Stainless steel screen, wide mesh	225-2647	2



*For Cassette Blanks
see page 97*

Cassette Shrink Bands

Specifically designed for use with sampling cassettes, SKC Cassette Shrink Bands are self-sealing, provide a smooth writing surface for sample identification, and make tampering evident.



Fit Cassette Diameter (mm)	Color	Cat. No.	Qty.	Cat. No.	Qty.
25	White	225-2503	100	225-2503A	1400
25	Clear	—	—	225-2510	1400
25	Yellow	—	—	225-2514	1400
37	White	225-25	100	225-25A	1000
37	Clear	225-2509	100	225-2509A	1000
37	Orange	225-2504	100	225-2504A	1000
37	Yellow	225-2507	100	225-2507A	1000
37	Red	225-2508	100	225-2508A	1000
37	Black	—	—	225-2515A	1000

Tubing for Connecting Pump and Media

Description/Applications	ID mm (in)	OD mm (in)	Cat. No.	Meters (feet)
Tygon , sampling trains	4.76 (³ / ₁₆)	7.94 (⁵ / ₁₆)	225-1346	3 (10)
Tygon , sampling trains; fits over impinger sidearm, impinger inlet, filter cassette outlet, or Luer adapter	6.35 (¹ / ₄)	9.53 (³ / ₈)	225-13-4A	1 (3.3)
			225-13-4	3 (10)
			225-1345	15 (50)
Tygon , for calibrating DCS/DPS	7.94 (⁵ / ₁₆)	14.29 (⁹ / ₁₆)	225-1349	3 (10)
Tygon , for calibrating QuickTake Pump	9.53 (³ / ₈)	12.7 (¹ / ₂)	225-1351	3 (10)
			225-1352	15 (50)
Latex Rubber, black , sampling trains	4.76 (³ / ₁₆)	7.94 (⁵ / ₁₆)	226-03-003	3.7 (12)
Latex Rubber, black , sampling trains; fits over impinger sidearm, impinger inlet, filter cassette outlet, or Luer adapter	6.35 (¹ / ₄)	9.53 (³ / ₈)	226-03-004	3.7 (12)
Latex Rubber, amber , sampling trains; fits over impinger sidearm, impinger inlet, filter cassette outlet, or Luer adapter	6.35 (¹ / ₄)	9.53 (³ / ₈)	225-1347	3 (10)
Polyurethane, reinforced , sampling trains; fits over impinger sidearm, impinger inlet, filter cassette outlet, or Luer adapter	6.35 (¹ / ₄)	11.9 (¹⁵ / ₃₂)	225-1350	3 (10)
Spring Tubing Supports , use with ⁵ / ₁₆ -inch OD tubing to prevent kinking, pk/5			225-1348	17.00

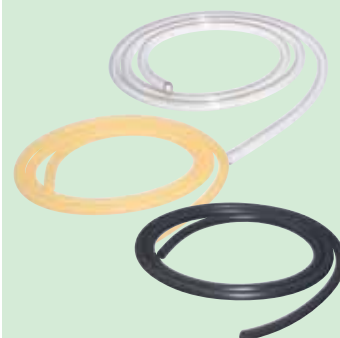

Tech Tips

- ▶ Consider your application before selecting tubing.
 - **Tubing attached to the sampling media outlet** does **not** contact the sample; therefore, the tubing used is not critical. Select the tubing best suited for the media and pump.
 - **Tubing attached to the sampling media inlet for gas/vapor sampling** contacts the sample during specialized applications such as bag sampling. Inert PTFE tubing is recommended because it prevents adsorption of the sample on the tubing's inner surface.
 - **Tubing attached to the sampling media inlet for particulate sampling** contacts the sample during specialized applications such as microvacuum sampling. Tygon tubing is typically used, as PTFE tubing can cause sample loss in the tubing due to static effect.

Sampling Accessories



Helmet Adapter*

Ideal for welders or workers who wear a helmet with face shield. Holds a filter cassette or sample tube in the breathing zone regardless of visor position.

Cat. No. 225-600

* Developed in Canada by IRSST (Institut de recherche Robert-Sauvé en santé et en sécurité du travail du Québec)

SKC Filter Cassette Holder

The lightweight SKC Filter Cassette Holder attaches firmly to the collar for sampling in the breathing zone. Its special design securely holds a 2 or 3-piece 37-mm cassette with or without cyclone, 25-mm cassette with cowl, or DPM Cassette with GS-1 Cyclone. The Filter Cassette Holder includes 0.9 meter (3 feet) of 1/4-inch ID Tygon tubing and a 25-mm adapter ring (cassette in photo **not** included).



Cat. No. 225-1

Filter Handling Kit

Includes SureSeal Cassette Opener, filter lifter, and non-serrated flat-tip forceps in a convenient carry case



Cat. No. 225-8372

Glass Jars

Sturdy 37-mm glass jars with PTFE-lined caps are ideal for transport and solvent extraction of filter samples in the field or the lab.



Cat. No. 225-8377 pk/36

Cat. No. 225-8376 pk/8

Stainless Steel Filter Lifter

Speeds removal of filters from cassettes without damage



Cat. No. 225-13-7

SureSeal Cassette Opener

The SureSeal Cassette Opener is a sturdy stainless steel crowbar with extended handle that makes opening 25 or 37-mm cassettes easy. *Required for all SureSeal Cassettes*



Cat. No. 225-13-5A

Calibration Jars

Rugged polypropylene SKC Calibration Jars feature a screw cap and barbed fitting for easy connection.



Standard Size, for GS Cyclones, aluminum PPIs, and low-volume PUF tubes

Cat. No. 225-111

Large Size fits 20.3-cm (8-inch) length x 8.3-cm (3.25-inch) diameter devices

Cat. No. 225-112

Forceps

Non-serrated flat tips for delicate membranes

Cat. No. 225-8371

Serrated pointed tips

Cat. No. 225-13-1

PTFE-coated pointed tips to avoid contaminants when sampling for hexavalent chromium

Cat. No. 225-1344



Sampling Labels

Identify samples with sample number, date, flow rate, pump number, time on, and time off



Cat. No. 225-1370 pk/500

Tubing, Collar Clip, and Cable Tie

For attachment of a sampling cassette to the collar; includes 0.9 meter (3 feet) of 1/4-inch ID Tygon tubing and one alligator clip attached to a nylon cable tie



Cat. No. 225-13-8

Collar Clip and Cable Ties Only

Cat. No. 225-13-6 pk/10

Cat. No. 225-13-6A pk/25

Cassette Adapters

PVC Luer taper adapters connect a cassette to 1/4-inch ID tubing.

Cat. No. 225-13-2 pk/10

Cat. No. 225-132A pk/250

Nickel-plated Brass

Cat. No. 225-13-3 pk/10



Sampling Accessories

Filter-Keeper Filter Transport and Storage

Minimize sample loss with static-dissipative plastic Filter-Keepers. The clamshell design locks the periphery of filters into place away from any surface. Eight Filter-Keepers can be kept in a numbered Filter-Keeper Archiving Tray that contains an area for labeling.

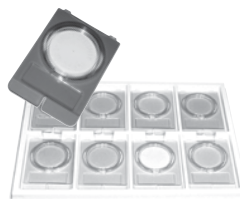

Description	Cat. No.	Qty.
25-mm Filter-Keepers include labels	225-8301	100
25-mm Filter-Keepers with 6 Archiving Trays include labels	225-8302	48
37-mm Filter-Keepers include labels	225-8303	100
	225-8303A	10
37-mm Filter-Keepers with 6 Archiving Trays include labels	225-8304	48
Archiving Trays Only	225-8305	6

Kasset-Kaddy

Each Kasset-Kaddy tray securely holds twenty-five 37-mm cassettes for convenient transport or storage. The polypropylene trays measure 25.4 x 25.4 cm (10 x 10 inches) to fit commercially available desiccators and ovens

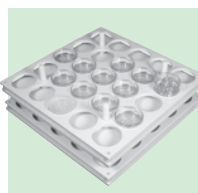

Cat. No. 225-8321.....pk/2

Petri Dish Slides

Easily transport filters up to 47 mm in diameter with Petri Dish Slides. The rectangular base fits most microscope stages



Cat. No. 225-2-01.....pk/100

Filter Transport Case

Conductive plastic case securely holds 25-mm filters for transport.



Cat. No. 225-67

Personal Exposure Vest

- Channel system prevents tubing snags/kinks
- Media held securely in breathing zone
- Consistent pump/media placement eliminates chance of error
- Configurable snap-on pockets (*sold separately*)
 - Locate in any of 6 positions around vest
 - Allows use of up to 6 instruments
- Even weight distribution for comfort
- Safety yellow and ANSI Class 2 compliant
- Breathable polyester mesh
 - Self-extinguishing/fire-resistant coating



Personal Exposure Vest for safe, comfortable sampling

Description	Cat. No.
Personal Exposure Vest with adjustable straps, requires Snap-on Pockets below	
Small - Large	223-600
XL - 3XL	223-601
Snap-on Pockets, form fitted for specific pump types	
AirChek 52, 2000, XR5000*	223-602
Universal XR Series	223-603

* Also fits 3M NoisePro Dosimeter



For size-selective samplers
see pages 106-117

Size-selective Samplers

Selection Guide

The SKC Particle Size-

Use this convenient guide to help select

Select a 50% Cut-point or Classification	< 1 µm	< 0.25 to > 2.5 µm	2.5 µm				3.5 µm	4 µm			
	Sub-micron	Ultrafine, Fine, and > PM2.5	PM2.5				Respirable	Respirable			

Select a Flow Rate (L/min)	1.7 or 2	9	2	3	4	10	10	2.8	3.7	2	2.5	2.75	4 and 8
----------------------------	----------	---	---	---	---	----	----	-----	-----	---	-----	------	---------

SKC Size-selective Samplers	DPM Cassette	Sioutas Impactor	PEM	PMI	PEM	IMPACT	PEM	Aluminum Cyclone	GS-3 Cyclone	PPI	Aluminum Cyclone	GS-3 Cyclone	PPI
Main Feature/Benefit	Ideal for DPM and nano-particles	Samples ultrafine, fine, and > PM2.5 particles simultaneously	Referenced in EPA IP-10A	High collection efficiency	Referenced in EPA IP-10A	High flow for increased sensitivity	Referenced in EPA IP-10A	Specified in NIOSH 7500 and 0600	Conductive plastic	Closest match to ISO/CEN curve	Specified in NIOSH 7500 and 0600	Conductive plastic	High flow for enhanced sensitivity
Page	95	117	114	115	114	116	114	111	110	112	111	110	112



Diesel Particulate Matter (DPM) Cassette
Page 95



Sioutas Personal Cascade Impactor Ultrafine/Fine/> PM2.5
Page 117



IMPACT PM2.5/PM10/Coarse Sampler
Page 116



Personal Modular Impactor (PMI) PM2.5/PM10/Coarse Sampler
Page 115



Parallel Particle Impactor (PPI)
Reusable and disposable models available
Respirable and Thoracic
Page 112



For sample pumps see pages 8-10, 14-15, and 18-19

selective Sampler Guide

sampling devices to meet your applications.

Select a 50% Cut-point or Classification	10 µm						100 µm		Particles < 10 µm but > 2.5 µm	
	Thoracic or PM10						Inhalable		PM Coarse	

Select a Flow Rate (L/min)	2	2	3	4	10	10	2	4	3	10
----------------------------	---	---	---	---	----	----	---	---	---	----

SKC Size-selective Samplers	PPI	PEM	PMI	PEM	PEM	IMPACT	IOM	Button Sampler	PMI	IMPACT
Main Feature/Benefit	Closest match to ISO/CEN curve	Referenced in EPA IP-10A	High collection efficiency	Referenced in EPA IP-10A	Referenced in EPA IP-10A	High flow for increased sensitivity	Meets U.S. international standards	Low-level PM sampling	High collection efficiency	High flow for increased sensitivity
Page	112	114	115	114	114	116	108	109	115	116



Respirable Dust Aluminum Cyclone
Page 111



GS-3 Respirable Dust Cyclone
Page 110



Button Inhalable Sampler
Page 109



IOM Inhalable Sampler
Page 108



Personal Environmental Monitor (PEM)
PM2.5/PM10 Sampler
Page 114



For electronic real-time particulate monitors
see pages 128

Inhalable Samplers

IOM

Professionals choose the authentic IOM!

Filter Heads

Although the Single Hole and Seven Hole heads may have been replaced by the IOM in some MDHS methods, they are still popular.

Single Hole "Lead Head"

Cat. No. 225-52



Seven Hole Head

Cat. No. 225-50



Asbestos Head

The 25-mm Asbestos Head is a cowled aluminum sampler designed for use with a gridded filter as per HSG 248 for asbestos fibers.

Cat. No. 225-54A

MultiDust Foam Discs

Separates and Collects Two PM Fractions

Use with a 25-mm filter in the IOM Sampler for simultaneous sampling of respirable and inhalable PM.

Cat. No. 225-772pk/10

Cat. No. 225-772-50.....pk/50



IOM Plastic Cassette with Transport Clip and Cover
Cat. No. 225-71A

IOM Sampler

A Gold Standard for Personal Inhalable PM Sampling

Meets U.S. and international standards

- ACGIH sampling criteria for inhalable particulate
- ISO/CEN health-related fractions of bioaerosols
- Preferred sampler for HSE Method MDHS 14/4
- NIOSH 5700 for particulate formaldehyde
- Australian standard for inhalable particulate
- OSHA-equivalent method for particulates not otherwise regulated (PNOR)[‡]

Small and lightweight

- Plastic model weighs less than 55 grams (2 ounces)

Maintains sample integrity

- Removable 25-mm cassette system eliminates filter handling
- Cassette and filter are weighed as a single unit to include all collected particles in analysis

Stainless steel cassette available for chemical analysis

- Autoclavable for bioaerosol sampling



Worker wearing the IOM Personal Inhalable Sampler

Sample Time:	Varies
Sample Rate:	2 L/min
Sample Pump:	Universal XR or AirChek Series
Sample Media:	25-mm filters [†]
Tubing:	1/4-inch ID

[‡] Reference: OSHA letter November 8, 2011; contact SKC for a copy

Choose the original IOM Sampler for optimal performance! The patented* IOM Personal Inhalable Sampler houses a reusable 25-mm filter cassette that holds a specified filter for the collection of inhalable particles. When attached to a personal sample pump operating at 2 L/min and clipped near a worker's breathing zone, the IOM effectively traps particles up to 100 µm in aerodynamic diameter. This collection method closely simulates how airborne workplace particles are inhaled through the nose and mouth. Both the plastic cassette and the filter are pre and postweighed as a single unit for gravimetric analysis. Alternatively, the stainless steel cassette can be used for chemical analysis.

Description	Cat. No.
IOM Sampler and cassette, [†] in conductive plastic, with transport clip and cover	225-70A
IOM Sampler and cassette, [†] in stainless steel, with transport clip and cover	225-76A
IOM Sampler, [†] in conductive plastic, with stainless steel cassette, transport clip, and cover	225-79A

* U.S. Patent No. 4,675,034

[†] A 25-mm filter is required for sampling with the IOM; see below.

25-mm Filters for IOM Sampler

The IOM Sampler requires a 25-mm filter for sampling. Select from the filters below to meet your application.

Description	Cat. No.	Qty.
PVC, 5.0 µm, 25 mm	225-5-25	100
Glass Fiber, 25 mm	225-702	500
MCE, 0.8 µm, 25 mm	225-1930	100
Polycarbonate, 0.8 µm, 25 mm	225-1601	100
Gelatin, sterilized, 25 mm	225-9551	50

Accessories

Description	Cat. No.
Cassette assembly, in conductive plastic, with transport clip and cover	225-71A
Cassette assembly, in stainless steel, with transport clip and cover	225-75A
Transport Clip and Cover	225-72A
IOM Calibration Adapter	391-01

Button Aerosol Sampler Chemical or Biological Inhalable Sampler

- 4 L/min flow rate enhances sensitivity
- Closely follows the ACGIH/ISO sampling criteria for inhalable particulate mass
- Inlet design reduces oversampling of very large particles and sensitivity to wind direction/velocity
- Suitable for area or personal sampling
- Stainless steel construction reduces electrostatic effects
- Suitable for collecting bioaerosols for viable or non-viable analysis
 - Autoclavable



Sample Time:	Varies
Sample Rate:	4 L/min optimum
Sample Pump:	AirChek XR5000 or TOUCH
Sample Media:	25-mm filters
Tubing:	1/4-inch ID

The patented* reusable SKC Button Aerosol Sampler features a porous curved-surface inlet designed to improve the collection characteristics of inhalable dust (< 100- μ m aerodynamic diameter), including bioaerosols for viable or non-viable analysis. The conductive stainless steel inlet contains evenly spaced holes that act as sampling orifices for multi-directional sampling and low sensitivity to wind direction and velocity. The proximity of the filter to the inlet minimizes transmission losses and provides for equal distribution of particle loading and low intersample variation. The Button Sampler follows closely the ACGIH/ISO sampling criteria for inhalable particulate mass at 4 L/min. A convenient conductive plastic transport case is available for shipping samples to a laboratory for analysis.

Description	Cat. No.
Button Sampler , requires a 25-mm filter; see below	225-360
Button Sampler Pump Kit includes Button Sampler, standard XR5000 Sample Pump, single charger, 0.9 meter (3 feet) of Tygon tubing, and calibration adapter, requires a 25-mm filter; see below	100-240 V 210-4121
Abrasive Blasting Kit includes Button Sampler and protective shield, requires a 25-mm filter; see below	225-367
Accessories	
Protective Shield , for abrasive blasting environments	225-366
Button Sampler Calibration Adapter	225-361
Filter Transport Case , for 25-mm filters, conductive plastic	225-67

* U.S. Patent Nos. 5,954,845 and 5,958,111

Recommended 25-mm Filters for Button Sampler

The Button Sampler requires a 25-mm filter for sampling. SKC recommends pore sizes greater than 1 micron to lower back pressure and enhance sample time with personal sample pumps. Select from the filters below to meet your application.

Description	Cat. No.	Qty.
PVC , 5.0 μ m, 25 mm	225-5-25	100
Glass Fiber , 25 mm	225-702	500
MCE , 1.2 μ m, 25 mm	225-1912	100
PTFE ,† 3.0 μ m, 25 mm	225-1711	50
Gelatin , sterilized, 25 mm	225-9551	50

† Back pressure on PTFE filters can vary within the same lot.

Tech Tips

Sampling Bioaerosols with the Button Sampler

➤ For growth cultures, use the Button Sampler with a sterile gelatin filter to help maintain microorganism viability.



Recommended Pumps for Button Sampler

AirChek **TOUCH** or
AirChek **XR5000**
see pages 8-10 or 14-15



More Information

www.skcinc.com

Respirable Samplers

GS-3/GS-1 Cyclones

Tech Tips

► Traditionally, respirable dust sampling with a cyclone has been performed using a clear styrene cassette. NIOSH now suggests that conductive black polypropylene cassettes are a better option for this application to minimize cassette wall losses (*Journal of Occ. and Env. Hygiene*, 10:3, 2013, pp. D29-D33). For conductive black polypropylene cassettes, see page 90.

GS Cyclones Accessories/Replacement Parts

Replacement Cassette Adapter	
37 mm.....	Cat. No. 225-102
25 mm.....	Cat. No. 225-101
Filter Cassette/Cyclone Holder, see p. 102 for details	
Cat. No.	225-1
Standard-size Multi-purpose Calibration Jar, see p. 104 for details	
Cat. No.	225-111
Replacement Grit Pots, pk/25	
Cat. No.	P225012



More Information

Gautam, M. and Sreenath, A., "Performance of a Respirable Multi-inlet Cyclone," *Jnl. of Aerosol Science* (U.K.), Vol. 28, No. 7, 1997, pp. 1265-1281

Kar, K. and Gautam, M., "Orientation Bias of the Isolated 10 mm Nylon Cyclone at Low Stream Velocity," *AIHA Journal*, Vol. 56, 1995, pp. 1090-1098

www.skinc.com

GS-3 Respirable Dust Cyclone

Listed in OSHA Final Silica Rule

Operates at 2.75 L/min to conform to the ISO 7708 standard

- Listed in OSHA rule for silica
- Meets ACGIH respirable TLVs
- Higher flow rate increases sensitivity for lower concentrations

Unique design overcomes issues experienced with the 10-mm nylon cyclone

- Tangentially arranged inlets decrease particle loss caused by impaction
- Multiple inlets eliminate ambient wind speed and orientation effects

Conductive plastic eliminates electrostatic effects

- Safe for underground mine use



Sample Time:	Varies
Sample Rate:	2.75 L/min for 4- μ m cut-point* (ISO 7708 standard) 3.7 L/min for 3.5- μ m cut-point* - 1971 OSHA standard
Sample Pump:	Universal XR or AirChek Series
Sample Media:	25 or 37-mm filters in 3-piece cassettes
Tubing:	1/4-inch ID

Use the lightweight 10-mm GS-3 Cyclone with a 25 or 37-mm three-piece filter cassette. See Tech Tip at above left.

Description		Cat. No.
GS-3 Cyclone with bowl adapter, cassette adapter, and grit pot	37 mm	225-100
	25 mm	225-103

* Calibrated at U.K. Health and Safety Laboratory; visit www.skinc.com/prod/225-100.asp to view the collection efficiency curve

† Determined using experimental data obtained at flows from 2 to 4 L/min

GS-1 Respirable Dust Cyclone

Equivalent to 10-mm Nylon Cyclone Without Static Concerns

2 L/min flow rate provides sharp size selection at 4 μ m

- Meets ISO 7708 standard, OSHA rule for silica, and ACGIH respirable TLVs

Use at 1.7 or 2 L/min with DPM Cassette for MSHA DPM compliance sampling

- Screens out large particles to prevent DPM Cassette impactor and filter overload

Conductive plastic construction

- Eliminates electrostatic effects experienced with the 10-mm nylon cyclone
- Safe for underground mine use



Sample Time:	Varies
Sample Rate:	2 L/min for 4- μ m cut-point† (ISO 7708 Standard) 3 L/min for 3.5- μ m cut-point† (1971 OSHA Standard) 1.7 or 2 L/min with DPM Cassette (MSHA DPM sampling)
Sample Pump:	Universal XR or AirChek Series
Sample Media:	DPM Cassette or 37-mm filters in 3-piece cassettes
Tubing:	1/4-inch ID

Use the lightweight 10-mm GS-1 Cyclone with a standard 37-mm three-piece filter cassette or the SKC DPM Cassette.

Description	Cat. No.
GS-1 Cyclone includes bowl adapter, 37-mm cassette adapter, and grit pot	225-105

‡ Trakumas, S., et al., "Performance Assessment of Personal Respirable Cyclone Samplers," *AIHce Presentation 191*, 2003

† Determined using experimental data obtained at flows from 2 to 4 L/min

Respirable Dust Aluminum Cyclone Specified in NIOSH Respirable Dust Methods

- ▶ Operates at 2.5 L/min to conform to the ISO 7708 standard
 - Meets requirements in the OSHA rule for silica
 - Meets ACGIH respirable TLVs
- ▶ Specified in NIOSH Method 7500 for silica and NIOSH 0600 for respirable particulates
- ▶ Eliminates adverse electrostatic effects
- ▶ Small and lightweight
 - 6.6 x 3.8 cm (2.6 x 1.5 inches)
- ▶ Used with an open-face three-piece cassette for more even particle deposition on the filter
 - Available in 25 or 37 mm
 - Inserts into middle ring of cassette



Sample Time:	Varies
Sample Rate:	2.5 L/min for 4- μ m cut-point* (2.8 L/min for 3.5- μ m cut-point†)
Sample Pump:	Universal XR or AirChek Series
Sample Media:	25 or 37-mm filters in 3-piece cassettes
Tubing:	1/4-inch ID

The SKC Aluminum Cyclone is a lightweight respirable dust sampler that is placed into the middle ring of a three-piece cassette loaded with the appropriate filter (see *Tech Tips* at right). When attached to a sample pump, respirable particles collect on the filter and larger particles fall into the grit pot to be discarded. Available in 25 or 37 mm, the SKC Aluminum Cyclone provides sharp size selection of the respirable fraction. The SKC Aluminum Cyclone eliminates the electrostatic problems associated with nylon (non-conductive) cyclones and allows the cyclone to sample particles more efficiently.

ACGIH, NIOSH, the European Standard Committee (CEN), and the OSHA rule on silica specify a respirable collection efficiency curve with a median cut-point of 4 μ m. A leading aerosol research organization calibrated the SKC Aluminum Cyclone. Results showed that using the cyclone at a flow rate of 2.5 L/min* provided the optimum match to the respirable curve specified in the ISO 7708 standard.

Cassette Holder

The lightweight SKC Filter Cassette Holder is designed for attachment to a worker's collar and will accommodate either two or three-piece 37-mm cassettes with or without a cyclone, 25-mm cassette with cowl, or DPM Cassette with a GS-1 Cyclone.



Cat. No. 225-1

Easy-to-use Calibration Adapter

The aluminum calibration adapter fits both the 25 and 37-mm Aluminum Cyclones and allows standard 1/4-inch ID Tygon tubing to be attached for simple calibration.



Cat. No. 225-01-03

Description		Cat. No.
Cyclone [‡] with grit pot	25 mm	225-01-01
	37 mm	225-01-02
Accessories		
Calibration Adapter, 25/37 mm		225-01-03
Filter Cassette Holder, 25/37 mm		225-1
Replacement Grit Pots, pk/25		P225011
Replacement O-rings, for 37-mm cyclones, pk/5		P22501

* As previously published, a flow rate of 2.6 L/min will yield a 4- μ m 50% cut-point, however, a 2.5 L/min flow rate will provide a better match over the entire curve.

† Determined using experimental data obtained at flows from 2 to 4 L/min

‡ Three-piece cassettes are required for use with SKC Aluminum Cyclones; see filter cassettes on pages 88-96.

Tech Tips

- ▶ A cyclone will not sample optimally if it is influenced by electrostatic charge. SKC cyclones are constructed of conductive plastic or aluminum that eliminates the static problem associated with non-conductive nylon cyclones.
- ▶ Cleaning cyclones before sampling prevents deviation in the collection efficiency curves.
- ▶ The cyclone grit pot must be in place during sampling for size selection to occur. Do **not** remove the grit pot during calibration and sampling.
- ▶ When calibrating size-selective samplers such as cyclones, use the sampler's calibration adapter. If an adapter does not exist, use the multi-purpose calibration jar with the smallest volume. See page 104.

Plastic Cyclone

The SKC Plastic Cyclone is designed to sample respirable dust as per MDHS 14/4 and the ISO/CEN criteria. The static-dissipating cyclone features a snap-together cassette system and is used at a 2.2 L/min flow rate with a 25 or 37-mm cyclone cassette. Cyclones include a grit pot. The Plastic Cyclone is also suitable for MDHS 10/2 and 91.



Description	Cat. No.
Plastic Cyclone with 25-mm plastic cassette	225-69
Plastic Cyclone with 37-mm plastic cassette	225-69-37
Filter Transport Cassette for 25-mm filters	225-67
Cassette, 25 mm	225-62
Cassette, 37 mm	225-62-37

Respirable/Thoracic Samplers

Parallel Particle Impactors (PPIs)

Parallel Particle Impactors (PPIs)

Designed for a Precise Match to the ISO 7708 Standard



- Collection efficiency precisely matches ISO 7708 standard
- Two sampler configurations available
 - Reusable conductive aluminum samplers
 - Disposable anti-static plastic samplers designed for one-time use, pre-assembled with:
 - Filter, support pad, and impaction substrates for chemical analysis
 - Substrates only for gravimetric analysis (add your own weighed filter)
- Sampling options:
 - 8 L/min respirable model: Enhanced sampling sensitivity for TLV-TWA silica and other compounds with low target concentrations, such as respirable manganese. Ideal for short-term task monitoring
 - 4 L/min respirable model: Provides higher flow option and use of intrinsically safe personal pumps
 - 2 L/min respirable model: Standard TWA sampling
 - 2 L/min thoracic model: Metalworking fluids (NIOSH Method 5524) or TLV-TWA sulfuric acid or cotton dust sampling
- Performance published in *Journal of Physics* and submitted to OSHA docket on silica



ABOUT

Using PPI Samplers on Welders



Several professionals report that they prefer using PPI Samplers.

- Smaller and more comfortable, PPIs fit easily under a welding helmet.
- Welders are often in awkward positions, which can cause a cyclone to tip and larger particles in the grit pot to land on the filter. This is not a problem for PPIs!

The PPI 4-in-1 Advantage

Only the patented[‡] SKC Parallel Particle Impactor (PPI) has the power of four impactors in one small sampler to provide a precise match to the ACGIH/ISO/CEN (7708:1995) thoracic or respirable conventions: a job no other single personal impactor can do alone!

Reduce Particle Buildup/Bounce Effects

Disposable pre-oiled porous plastic impaction substrates reduce the negative effects of particle buildup and bounce on sample accuracy by firmly trapping larger particles. Unlike other samplers, SKC PPI sampling efficiency does not depend on collected particle type. In addition, PPI Samplers can be inverted without larger particles invalidating results.

[‡] U.S. Patent No. 7,073,402

Sample Rate:	2, 4, or 8 L/min
Sample Pump:	Universal XR or AirChek Series; Leland Legacy for 8 L/min
Sample Media:	37-mm filter (requires support and impaction substrates)
Tubing:	1/4-inch ID

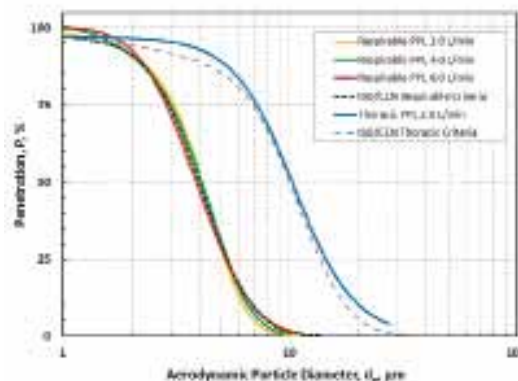





Comparison of PPI Samplers' performance with thoracic and respirable conventions

Parallel Particle Impactors (PPIs)

Available in Reusable Aluminum or Disposable Plastic

Reusable Aluminum PPI Samplers





Select the PPI for the desired convention, choose an application-appropriate filter and support, and order impaction substrates.

Description	Cat. No.	Qty.
Reusable PPI Samplers, require substrates, filters, and supports		
Respirable PPI (red), 8 L/min, aluminum 	225-383	ea
Respirable PPI (orange), 4 L/min, aluminum 	225-382	ea
Respirable PPI (gold), 2 L/min, aluminum 	225-380	ea
Thoracic PPI (blue), 2 L/min, aluminum 	225-381	ea

Impaction Substrates, four required for each sample for Reusable Aluminum PPI models	Cat. No.	Qty.
Porous Plastic Discs,† 9.53-mm (3/8-inch) diameter, pre-oiled, ready to use, disposable	225-388	200

Disposable Plastic PPI Samplers**

Select the PPI for the desired convention. Choose from models preloaded with filter and support or load your own.

Description	Cat. No.	Qty.
Preloaded Disposable PPI Samplers contain four porous plastic disc impaction substrates, one 37-mm cellulose support, and one collection filter as noted		
Respirable PPI (red), 8 L/min, plastic, with 5.0-µm PVC filter	225-3841	ea
Respirable PPI (orange), 4 L/min, plastic, with 5.0-µm PVC filter	225-3871	ea
Respirable PPI (gold), 2 L/min, plastic, with 5.0-µm PVC filter	225-3851	ea
Thoracic PPI (blue), 2 L/min, plastic, with 0.8-µm MCE filter	225-3861	ea
Disposable PPI Samplers contain four porous plastic disc impaction substrates, require collection filter and support; see information below and select based on application		
Respirable PPI (red), 8 L/min, plastic 	225-384	ea
Respirable PPI (orange), 4 L/min, plastic 	225-387	ea
Respirable PPI (gold), 2 L/min, plastic 	225-385	ea
Thoracic PPI (blue), 2 L/min, plastic 	225-386	ea

Filters for User-loaded PPI Samplers	Cat. No.	Qty.
PVC Filters, 37 mm, 5.0-µm pore size	225-5-37	100
PTFE Filters,* 37 mm, 2.0-µm pore size for metalworking fluids (NIOSH 5524)	225-27-07	50
MCE Filters, 37 mm, 0.8-µm pore size	225-5	100

Filter Supports for User-loaded PPI Samplers	Cat. No.	Qty.
Support Pads, cellulose, 37 mm	225-27	100
Stainless Steel Screen, 37 mm, wide mesh	225-26	ea

Accessory	Cat. No.	Qty.
Calibration Adapter, for Disposable PPI Samplers only	225-389	ea

* Back pressure on PTFE filters can vary within the same lot.

** Designed for one-time use

† Limited shelf-life

Standard of Good Practice

Before and after sampling, weigh filters in a weighing room using the same analytical balance and conditions each time. With this good practice in mind, SKC does not supply PPI Samplers loaded with preweighed filters. Contact a laboratory to request preloaded, preweighed PPI samplers for higher accuracy.

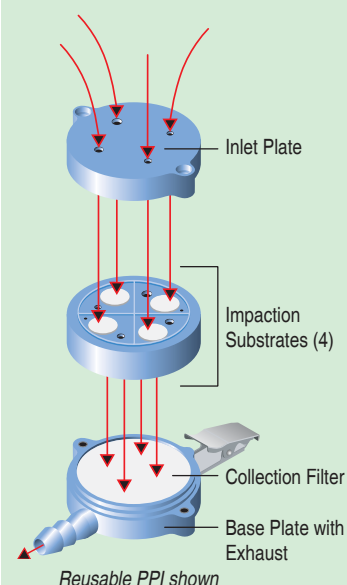

PM2.5/PM10 Samplers

Personal Environmental Monitor (PEM)

Pumps for sampling with the PEM



- 2 or 4 L/min flow rates, see pages 8-10 or 14-15
- 10 L/min flow rate and 24-hour sampling, see pages 22-23

PEM Applications

- Childhood asthma studies
- Green Building certification
- IAQ studies
- School zone investigations

Data Interpretation

Particulates as PM_{2.5}

- ▶ LEED Green Buildings Indoor Air Maximum Concentration: 15 µg/m³

Source: LEED for New Construction Rating System v4 (U.S. Green Building Council, <http://www.usgbc.org>)

Personal Environmental Monitor (PEM)

Choice of Flows for PM10 and PM2.5 in Indoor Air

- ▶ Referenced in EPA Method IP-10A
 - For particles in indoor air
- ▶ Small and unobtrusive
 - Can be connected to a personal sample pump and worn in the breathing zone
- ▶ Suitable for LEED Green Building sampling



The Personal Environmental Monitor is a small, lightweight impaction device used with a personal sample pump to provide effective sampling of PM10 and PM2.5 in indoor air. Personal exposure is determined through gravimetric analysis for particle mass and chemical analysis for specific compounds.

Sample Time:	Varies
Sample Rate:	2, 4, or 10 L/min
Sample Pump:	Universal XR, AirChek Series, or Leland Legacy
Sample Media:	37-mm PTFE filters*
Tubing:	3/16-inch ID

How the PEM Works

The PEM consists of three major parts: cap, impaction ring assembly, and base. A 37-mm after-filter is inserted in the base and the PEM assembled. When used with a personal sample pump at the required flow rate, aerosol is accelerated through a number of nozzles in the cap. Through inertia, particles larger than the 50% cut-point of the sampler impact onto a greased impaction ring and can be discarded after sampling. Particles smaller than the 50% cut-point pass through the impactor and collect on the 37-mm after-filter. Six models of PEM are available for the collection of PM10 or PM2.5 at three different flow rates.

Cut-point	Model	Flow Rate	Cat. No.
2.5 µm		2 L/min	761-203
		4 L/min	761-203A
		10 L/min	761-203B
10 µm		2 L/min	761-200
		4 L/min	761-200A
		10 L/min	761-200B
Accessories			
PEM Calibration Adapter			761-202
After-filter, 37-mm, 2.0-µm PTFE* with PMP support ring, pk/50			225-1709

* Back pressure on PTFE filters can vary within the same lot.

Personal Modular Impactor (PMI)

Personal PM10, PM2.5, or PM Coarse Sampling at 3 L/min

- ▶ **Models available for PM10, PM2.5, or PM Coarse** (10-2.5) **sampling**
- ▶ **Use with any constant flow pump at 3 L/min**
- ▶ **Disposable ready-to-use pre-oiled impaction discs — no cleaning or greasing**
 - Reduce particle bounce for high collection efficiency
- ▶ **Compact and lightweight — only 71 grams (2.5 ounces)!**
 - Ideal for personal or micro-environmental sampling
- ▶ **Closely follows PM2.5 or PM10 as defined by EPA (see right)**
- ▶ **Convenient modular design for easy operation**
 - Removable filter cassette for easy media changes
 - Convenient clip for mounting sampler in the breathing zone
- ▶ **PMI PM10 model is easily converted with accessory ring to measure PM Coarse**



Sample Time:	Varies
Sample Rate:	3 L/min
Sample Pump:	Universal XR or AirChek Series
Sample Media:	37-mm filter (requires impaction substrate)
Tubing:	1/4-inch ID

The patented* SKC single-stage Personal Modular Impactors are designed for the highly efficient collection of PM10, PM2.5, or PM Coarse (10-2.5). The samplers are easy to use with a removable filter cassette and pre-oiled impaction disc. The 25-mm pre-oiled impaction disc mounts directly on top of the filter cassette and reduces particle bounce for high collection efficiency. A 25-mm filter may be used as an alternative impaction substrate for chemical analysis of particles. The PMI Coarse model includes a second filter cassette to allow collection of particles < 10 µm but larger than 2.5 µm.

ABOUT

PMI Performance

The graph below demonstrates the high sampling efficiency of the PMI PM2.5 and PM10 Samplers when compared to the EPA PM2.5 and PM10 criteria curves. For more information, see the Modular Impactor Poster Presentation at www.skinc.com/instructions/Modular_Impactors_Poster.pdf.

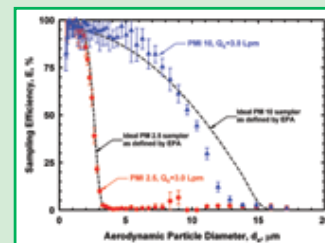

10 L/min IMPACT
Single-stage Impactor
see page 116

PMI Sampler	Cat. No.	Qty.
Personal Modular Impactor includes impactor and filter cassette with support screen, requires collection media and impaction substrate sold separately; see below		
PM2.5 (gold)	225-352	ea
PM10 (silver)	225-350	ea
PM Coarse includes 2 filter cassettes and filter retainer	225-351	ea
Recommended Collection Filters		
Quartz Filters , 37 mm, Tissuquartz, 432 µm thick	225-1822	25
PTFE Filters ,† 37 mm, 2.0-µm pore size, with PMP support ring	225-1709	50
PTFE Filters ,† 37 mm, 1.0-µm pore size, with laminated PTFE support	225-2705	50
Recommended Impaction Substrate, required for sampling; limited shelf-life		
Pre-oiled Porous Plastic Discs ,‡ 25 mm, ready to use, disposable	225-355	25
	225-355A	50
Accessories		
PM Coarse Ring includes filter cassette, adapts a PMI 10 to a PMI Coarse	225-3512	ea
Replacement Filter Cassette	225-356	ea
PMI Cassette Opener	225-357	ea
Forceps , stainless steel, non-serrated flat tips, see p. 104	225-8371	ea
Filter-Keepers , 37 mm, for filter transport, see p. 105	225-8303	100
	225-8303A	10
PMI Calibration Adapter	225-358	ea
Filter Retainer , secures filter in impaction substrate position on top of cassette	225-354	ea

* U.S. Patent No. 7,334,453 † Back pressure on PTFE filters can vary within the same lot.
 ‡ A 25-mm filter may be used as an alternative impaction substrate for chemical analysis.

Data Interpretation

Particulates as PM10

- ▶ **LEED Green Buildings**
 Indoor Air Maximum Concentration: 50 µg/m³
 Health Care Facilities have a maximum of 20 µg/m³

Source: LEED for New Construction Rating System v4 (U.S. Green Building Council, <http://www.usgbc.org>)

PM2.5/PM10/PM Coarse Samplers

IMPACT Sampler



IMPACT and the Leland Legacy Sample Pump

While IMPACT can be used with any pump at 10 L/min, partnering IMPACT with the Leland Legacy sample pump provides a highly efficient sampling system. The quiet, fully programmable Leland Legacy pump can provide a constant 10 L/min flow rate for 24 hours, making it ideal for environmental monitoring or indoor air studies. *For more information on the Leland Legacy Sample Pump, see pages 22-23. IMPACT and the Leland Legacy Sample Pump are both included in the DPS System on pages 24-25.*

Convenient All-in-one Filter Cassette

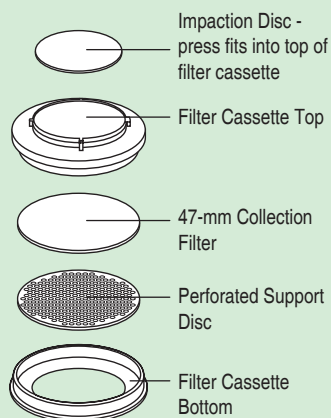

IMPACT Sampler

For PM10, PM2.5, or PM Coarse Sampling at 10 L/min

- Ideal for environmental PM sampling and indoor air studies
- Use with Leland Legacy or any pump at 10 L/min
- Compact design
- Higher flow rate provides increased sensitivity
- Convenient operation
 - Removable filter cassette for fast media changes
 - Disposable ready-to-use pre-oiled impaction discs reduce particle bounce — no cleaning or greasing
 - Included rain cover protects sampler during outdoor use
 - Optional quick-mount bracket secures sampler virtually anywhere

Featured in the DPS System!
see pages 24-25



Sample Time:	Varies
Sample Rate:	10 L/min
Sample Pump:	Leland Legacy
Sample Media:	47-mm filter (requires impaction substrate)
Tubing:	3/8-inch ID

The patented[‡] SKC IMPACT single-stage inertial impactor is designed for the efficient collection of PM10, PM2.5, or PM Coarse (10-2.5) in ambient air. A sample pump operating at 10 L/min draws particulate matter (PM) through the impactor; larger particles are captured on a disposable pre-oiled impaction disc while smaller particles collect on a 47-mm filter. IMPACT media changes are as easy as removing the filter cassette and replacing it with one already loaded. The impaction disc fits into the top of the cassette. IMPACT's higher flow rate requirement provides increased sensitivity for low levels of PM. Go to www.skcin.com/instructions/Modular_Impactors_Poster.pdf for sampling efficiency data.

IMPACT Sampler	Cat. No.	Qty.
IMPACT Sampler includes filter cassette, calibration adapter, and rain cover for sampler; requires collection media and impaction substrate sold separately; see below		
PM2.5	225-392	ea
PM10	225-390	ea
PM Coarse includes 2 filter cassettes	225-3911	ea
Collection Filters for IMPACT Sampler (not supplied with IMPACT or DPS System) <i>Select a filter based on your application; required for sampling</i>		
Quartz Filters, 47 mm, Tissuquartz, 432 µm thick	225-1823	25
PTFE Filters, [§] 47 mm, 2.0-µm pore size, with PMP support ring	225-1747	50
Impaction Substrate		
Impaction Discs, 37 mm, pre-oiled, ready to use, disposable, required for sampling; limited shelf-life	225-395	25
	225-395A	50
Accessories		
Replacement Filter Cassette	225-396	ea
Filter Cassette Opener	225-397	ea
Mounting Bracket	225-399	ea
PM Coarse Ring includes filter cassette, adapts IMPACT PM10 to an IMPACT PM Coarse	225-3912	ea
Petri Dish Slide, for filter transport	225-2-01	100
Calibration Adapter	225-394	ea

[‡] U.S. Patent No. 7,334,453

[§] Back pressure on PTFE filters can vary within the same lot.

For a deployable particulate sampling system featuring the IMPACT Sampler, see the DPS System on pages 24-25.

Sioutas Personal Cascade Impactor

Separates Ultrafine, Fine, and > 2.5-µm Particles Simultaneously

► **Precise particle separation**

- Particle size cut-points: 2.5 µm, 1.0 µm, 0.50 µm, and 0.25 µm
- The only personal impactor that efficiently samples ultrafine, fine, and > 2.5-µm particles simultaneously
- Maintains high collection efficiency even at high particle concentrations

► **Optimized at a 9 L/min flow rate with low pressure drop for 24-hour sampling**

- Improves analytical sensitivity
- Minimizes non-detectable samples

► **Preserves unstable compounds**

- Chemically inert collection substrate
- No impaction grease to contaminate sample

► **Minimal particle bounce and internal wall losses**

► **Suitable for indoor and outdoor sampling****

► **Size-fractionated samples can be analyzed gravimetrically, chemically, and microscopically**

► **Small and lightweight**

- Suitable for personal or area sampling



ET✓

Sample Time:	Varies
Sample Rate:	9 L/min
Sample Pump:	Leland Legacy
Sample Media:	25 and 37-mm filters
Tubing:	3/8-inch ID



Leland Legacy Sample Pump

The compact, portable, and battery-operated Leland Legacy Sample Pump provides 9 L/min flow rate for optimum Sioutas Impactor performance.

For more information, see pages 22-23.

the Sioutas Impactor **Advantage!**

Choose the Sioutas Personal Impactor for the highly efficient collection of airborne particles in five size ranges:

- ✓ > 2.5 µm
- ✓ 1.0 to 2.5 µm
- ✓ 0.50 to 1.0 µm
- ✓ 0.25 to 0.50 µm
- ✓ < 0.25 µm

Recent epidemiological studies show that ultrafine, fine, and > 2.5-µm particles may have greater pulmonary inflammatory potency than larger particles and associate increased morbidity and mortality with increased exposure to these particles. The Sioutas Impactor is the only personal impactor that precisely separates and collects ultrafine, fine, and > 2.5-µm particles simultaneously.

More Information

Misra, C., et al., "Development and Evaluation of a Personal Cascade Impactor Sampler (PCIS)," *Journal of Aerosol Science*, 33, 2002, pp. 1027-1047

The patented[†] Sioutas Personal Cascade Impactor^{*} separates and collects airborne particles in five size ranges: > 2.5 µm, 1.0 to 2.5 µm, 0.50 to 1.0 µm, 0.25 to 0.50 µm, and < 0.25 µm. When used with PTFE filters,[‡] the Sioutas Impactor is highly efficient at collecting particles without using impaction grease or substrate coatings and at retaining unstable compounds for size-fractionated chemical analysis.

Use the Sioutas Impactor with the Leland Legacy Sample Pump at 9 L/min to ensure precise particle separation at the specified cut-points. Particles above each cut-point are collected on a 25-mm filter in the appropriate stage with particles less than 0.25 µm collecting on the 37-mm after-filter (optional). The small, lightweight Sioutas Impactor simply clips to a worker's collar or lapel for personal sampling and is also suitable for area sampling.

Description	Cat. No.
Sioutas Personal Cascade Impactor	225-370
Tubing , Tygon, 9.53-mm (3/8-inch) ID, fits Sioutas Impactor and Leland Legacy pump, 3 meters (10 feet)	225-1351

Filters for Sioutas Impactor

Description	Cat. No.	Qty.
After-filter , PTFE, [‡] 37 mm, 2.0 µm (optional)	225-1709	50
Collection Filter (filter for 4 stages), PTFE, [‡] 25 mm, 0.5 µm, required	225-2708	100

* Developed by Dr. Constantinos Sioutas of the University of Southern California in partnership with the Mickey Leland National Urban Air Toxics Research Center (NUATRC)

† U.S. Patent No. 6,786,105 (University of Southern California)

‡ Back pressure on PTFE filters can vary within the same lot.

** Requires special provisions; see product operating instructions

ABOUT

Monitoring Exposure to CNTs and CNFs

In its Current Intelligence Bulletin 65: *Occupational Exposure to Carbon Nanotubes (CNTs) and Nanofibers (CNFs)*, NIOSH recommends use of a respirable mass-based airborne concentration measurement to monitor worker exposure to all types of CNTs and CNFs until additional data are available. A reasonable estimate of worker respirable exposure to CNTs/CNFs at the NIOSH REL (1 µg/m³, 8-hour TWA) can be determined as elemental carbon (EC) by NIOSH Method 5040.







SKC Bioaerosol Samplers

Personal, Area, and Surface Sampling



SKC Bioaerosol Sampler Guide

Use the guide below to determine the sampler that meets your applications.

Sampler	Principle of Operation	Flow Rate (L/min)	Contaminants	Sampler Advantages	Page
 <p>Button Sampler</p>	Filtration using porous membrane	4 (optimum)	Fungi (viable and non-viable), endotoxins, and bacteria	<ul style="list-style-type: none"> Superior collection uniformity Low sensitivity to ambient conditions Sample suitable for viable and non-viable analysis Personal bioaerosol sampling 	119
 <p>BioStage Single-stage Impactor</p>	Impaction onto culture media	28.3	Fungi (viable) and bacteria	<ul style="list-style-type: none"> SureLock positive seal Organisms remain intact and viable Cost-effective and reusable Time-proven collection method Meets NIOSH Methods 0800 and 0801 	120
 <p>BioSampler</p>	Collection into swirling liquid	12.5 (sonic flow)	Fungi (viable and non-viable), endotoxins, viruses, and bacteria	<ul style="list-style-type: none"> Maintains constant collection efficiency over 8 hours Reduces particle bounce and re-aerosolization; preserves viability Many analysis options 	122
 <p>Sterile Swab Kit</p>	Wipe sample	N/A	Fungi (viable and non-viable) and bacteria	<ul style="list-style-type: none"> Easy to use Suitable for growth cultures Non-destructive Collects surface contaminants 	124
 <p>Carpet Sampling Cassette</p>	Filtration using porous membrane	10 (optimum)	Fungi (total) and fibers	<ul style="list-style-type: none"> Easy to use Suitable for high flows to enhance detection Microvacuum nozzle for efficient sampling in carpeting 	124
 <p>Stick-to-it</p>	Lift tape surface sample	N/A	Fungi (total), pollen, and fibers	<ul style="list-style-type: none"> Ensures consistent sample area Serialized for sample identification Includes transport case for mailing to lab 	124
 <p>VersaTrap Spore Trap Cassette</p>	Impaction onto sticky glass slide	15 (optimum)	Fungi (total), pollen, and fibers	<ul style="list-style-type: none"> Reduces particle bounce Prevents sample loss and blurring Allows direct quantitative analysis Enumeration of fungal spores with low culturability 	125

Button Aerosol Sampler

Autoclavable, Personal Filter Sampler for Bioaerosols

- ▶ 4 L/min flow rate enhances sensitivity
- ▶ Follows closely the ACGIH/ISO sampling criteria for inhalable particulate mass
- ▶ Inlet design reduces oversampling of very large particles and sensitivity to wind direction/velocity
- ▶ Stainless steel construction reduces electrostatic effects
- ▶ Small, lightweight for personal sampling; ideal for area sampling
- ▶ Can collect bioaerosols for viable or non-viable analysis
 - Autoclavable



Sample Time:	Varies
Sample Rate:	4 L/min optimum
Sample Pump:	AirChek XR5000 or TOUCH
Sample Media:	25-mm filters
Tubing:	1/4-inch ID

The patented* Button Aerosol Sampler provides superior collection of inhalable particles, including bioaerosols such as bacteria and fungal spores for viable or non-viable analysis. Its high collection efficiency is due to its unique features:



- **Porous curved-surface inlet** improves collection characteristics of inhalable particles (< 100- μ m aerodynamic diameter).
- **Stainless steel inlet** reduces electrostatic effects and contains evenly spaced holes that act as sampling orifices for multi-directional sampling and low sensitivity to wind direction and velocity.
- **Filter proximity to the inlet** minimizes transmission losses and provides equal distribution of particles and low intersample variation.

The Button Sampler follows closely the ACGIH/ISO sampling criteria for inhalable particulate mass when operated with a sample pump at 4 L/min.

Selecting a Filter for Bioaerosol Sampling

Use the Button Sampler with a 25-mm gelatin filter to maintain the survival of stress-sensitive microorganisms during short sampling periods for viable analysis (*see information above right*). For non-viable analysis, use a 25-mm MCE or PVC filter.

Description	Cat. No.	Qty.
Gelatin, sterilized	225-9551	50
MCE, 1.2 μ m	225-1912	100
PVC, 5.0 μ m	225-5-25	100

Description	Cat. No.
Button Sampler, requires a 25-mm filter; see above	225-360
Button Sampler Pump Kit includes Button Sampler, standard AirChek XR5000 Sample Pump, single charger, 0.9 meter (3 feet) of Tygon tubing, and calibration adapter, requires a 25-mm filter; see above	100-240 V 210-4121
Accessories	
Button Sampler Calibration Adapter 	225-361
Filter Transport Case, for 25-mm filters, conductive plastic 	225-67

* U.S. Patent Nos. 5,954,845 and 5,958,111

ABOUT

Using Gelatin Filters with the Button Sampler

For maximum microorganism survivability and superior collection of inhalable-size bioaerosols, use sterile gelatin filters with the SKC Button Sampler. The Button Sampler features a unique inlet and proximity of the filter to the inlet to minimize transmission losses and provides for equal distribution of particles and low intersample variation. The Button Sampler is autoclavable, making it ideal for applications requiring pre-sterilization. Combining the Button Sampler with the nurturing properties of gelatin filters creates a sampler that is most efficient at collecting inhalable bioaerosols for viable or non-viable analysis.



More Information

Clark Burton, N., Grinshpun, S., Reponen, T., "Physical Collection Efficiency of Filter Materials for Bacteria and Viruses," *Annals of Occup. Hyg.*, Sept. 2006, pp. 1-9

Aizenberg, V., Reponen, T., Grinshpun, S., Willeke, K., "Performance of Air-O-Cell, Burkard, and Button Samplers for Total Enumeration of Airborne Spores," *AIHA Journal*, Vol. 61, Dec. 2000, pp. 855-864

Adshikari, A., et al., "Performance of the Button Sampler for Outdoor Bioaerosol Collection," abstract from American Assoc. of Aerosol Research Conf., NC, 2002

ABOUT

MRSA

Methicillin-resistant *Staphylococcus aureus* (MRSA) infections occur typically in hospitals, elder and child care facilities, gyms, schools, and jails. A 2008 IAQA presentation** recommends a viable cascade impactor (such as the SKC BioStage) with ChromAgar for sample times of 2 to 5 minutes for sampling MRSA in air and sterile swabs (see page 124) for sampling MRSA on surfaces where the superbug can live for weeks to months.



Single-stage impactor with spring clamps



Single-stage BioStage with SureLock seal



References

† Macher, J., "Positive-hole Correction of Multiple-jet Impactors for Collecting Viable Microorganisms," *AIHA Journal*, 50 (11), 1989, pp. 561-568

‡ Samimi, B. and Shufutinsky, A., "Comparison of the Thermo-Andersen N6, the Aerotech A6, the SKC BioStage, and the SKC Micro-media Viable Samplers in Collecting Airborne Fungal Spores," *AIHce 2005, San Diego, CA, Final Program*, p. 43

** Dobranic, J., "Superbugs in Our Communities - An Introduction for the IEQ Professional," *EMSL, IAQA Conference, Tampa, FL, 2008*

BioStage Single-stage Viable Cascade Impactor

- ▶ Easy to use
- ▶ Corrosion-resistant aluminum
 - Autoclavable
- ▶ Collected organisms remain intact and viable
- ▶ SureLock positive seal ensures sample integrity
- ▶ Uses standard-size agar plates
- ▶ Easy setup and calibration
- ▶ Proven viable sampling
 - Meets ACGIH recommendations for bioaerosol sampling
 - Meets NIOSH Method 0800 and 0801 requirements
 - Studies show performance equivalent to Andersen N-6 and similar samplers†

The SKC BioStage® viable cascade impactor meets NIOSH requirements and ACGIH recommendations for sampling indoor and outdoor mold and bacteria (see *PDB # 1512*). The BioStage comprises an inlet cone, precision-drilled 400-hole impactor stage, and a base that holds a standard-size agar plate. A high flow pump, such as the QuickTake 30 (see page 121), pulls microorganisms in air through the holes (jets) where they are collected on the agar surface. Testing demonstrates that BioStage provides performance equivalent to the industry-standard Andersen N-6. What sets BioStage apart from other samplers is its SureLock positive seal (instead of bulky spring clamps) that ensures sample integrity.

SureLock seal for sample integrity — only from SKC!



	BioStage
Jet Classification Stage	400 holes (0.25-mm diameter)
Sample Rate	28.3 L/min
Median Cut-point (D_{50})	0.6 μ m
Sample Media	90 to 100-mm agar plates
Analysis	Colony culture†
Tubing	1/4-inch ID

Description	Cat. No.
BioStage* single-stage cascade impactor; available in pump kit, see p. 121	225-9611
Accessories	
Calibration Adapter for BioStage, allows tubing to connect to BioStage inlet	P33100
Mounting Bracket for QuickTake 30, holds BioStage in place on pump during sampling	228-9531

* Requires microbiological media supplied by analytical laboratories; for a lab list, go to www.skcin.com and search on "laboratories"

BioStage Pump Kit Complete Viable Mold and Bacteria Sampling Kit

SKC combines the high-performance BioStage Viable Cascade Impactor with the power of the QuickTake 30 Sample Pump^Δ for a complete viable mold/bacteria sampling kit (see PDB # 1512). With your BioStage Pump Kit and fresh agar plates from your laboratory, you are ready to sample!

What does the kit include?

- BioStage Viable Cascade Impactor (see page 120)
- QuickTake 30 Sample Pump, 10 to 30 L/min constant flow (see pages 26-27)
- AC charger/adaptor
- Mounting bracket with inlet adapter designed to mount BioStage directly on the pump
- Calibration adapter
- Rotameter
- Tubing
- Deluxe carry case



QuickTake 30 Pump Applications

The QuickTake 30 Pump included in the BioStage Pump Kit can be used with many other samplers, including:

- Spore trap cassettes
- Asbestos cassettes
- Filter cassettes
- Wall cavity samplers
- Microvacuum cassettes
- Any viable cascade impactor within the flow range
- Any sampler requiring constant flows from 10 to 30 L/min within stated back pressure

Why use BioStage with the QuickTake 30 pump?

- Constant flows from 10 to 30 L/min
- Mounting bracket designed for BioStage to be mounted directly on the pump
- No noisy, hot, and AC-powered vacuum pump
 - QuickTake 30 is low noise and battery powered
- Powerful Li-Ion battery provides up to 4-hour run times at 28.3 L/min



Description	Cat. No.
BioStage Pump Kit-DC includes BioStage,* QuickTake 30 sample pump, AC charger/adaptor, mounting bracket with inlet adapter, calibration adapter, rotameter, tubing, and deluxe carry case	228-9530K
	100-240 V

^Δ QuickTake 30 pump is **not** CE marked.

* Requires microbiological media supplied by analytical laboratories; for a lab list, go to www.skinc.com and search on "laboratories"

BioSampler Analysis Options

- **Growth Culture Analysis** quantifies/characterizes airborne bacteria and fungi.
- **Microscopic Analysis** enumerates total airborne bacteria and fungi (provides limited identification).
- **Biochemical Assay** quantifies biological compounds based on reaction to a chemical.
- **Immunoassay** quantifies airborne allergens based on antibodies binding to a specific target antigen.
- **Polymerase Chain Reaction (PCR)** identifies bioaerosols by screening for a specific genus or species. *May require use of sterile water as collection liquid; check with laboratory.*

For a list of microbiological laboratories, visit www.skcinc.com and search on "laboratories."



BioSampler

Collects Bioaerosols into Liquid for Maximum Viability

- Ideal for airborne bacteria, fungi, pollen, viruses, endotoxins, mycotoxins, and other fragments
- Constructed of quality glass
- Collection method ensures high rate of microorganism viability
- Extends sample time to over 8 hours with ViaTrap liquid
- Overcomes sampling problems with impinger samplers
- Inlet limits collection of particles to those that would pass through the human nose

The patented* BioSampler® is a highly efficient glass collection device used with a high-volume sonic flow pump to trap airborne microorganisms for analysis. Externally, BioSampler resembles an All-Glass Impinger (AGI-30); internally, BioSampler is specially designed to reduce particle bounce and maintain maximum viability.

the BioSampler Advantage!

- ✓ Three tangential nozzles eject particles at an angle to the inner wall, reducing particle bounce and preserving microorganism integrity
- ✓ Patented swirling liquid collection method† minimizes re-aerosolization and gently entrains bioaerosols to preserve viability
- ✓ For highest efficiency, use with non-evaporating collection liquids that have a higher viscosity than water, such as ViaTrap® mineral oil.‡
- ✓ When used with ViaTrap, collection efficiency stays constant over an 8-hour sampling period.
- ✓ Complete glass construction allows easy cleaning, sterilizing, autoclaving, and reuse.
- ✓ Samples are suitable for five different analyses. *See above left.*

Sample Time:	Up to 8 hours
Sample Rate:	Sonic flow through BioSampler nozzles (12.5 L/min)
Sample Pump:	Vac-U-Go/BioLite
Sample Media:	ViaTrap‡
Tubing:	1/4-inch ID and 3/8-inch ID



Description	Cat. No.
BioSampler , three-piece glass including inlet section, outlet section, and collection vessel (does not include ground joint cap) pk/4	20 ml 225-9595 20 ml 225-9595K4 5 ml 225-9593
BioSampler Collection Vessel (bottom) and ground joint cap, for transporting samples	20 ml 225-9596 5 ml 225-9596A
BioSampler Mini Kit includes 1 BioSampler, two 20-ml collection vessels (bottoms) with caps, 1 BioSampler case with mounting rod, and 1 ViaTrap‡ (120 ml)	225-9597
ViaTrap Collection Media ,‡ special mineral oil for bioaerosol sampling	120 ml 225-9598A 500 ml 225-9598 950 ml 225-9599
Glass Trap , for area sampling to protect pump, can be used with or without sorbent, see p. 67 for sorbent Cat. No. 225-22-02	225-22

* U.S. Patent No. 5,902,385 (device)

† U.S. Patent No. 5,904,752 (method)

‡ May not be suitable for PCR analysis

Complete BioSampler System Ideal for Sampling Bacteria, Fungi, and Viruses

- Includes all equipment and media for bioaerosol sampling
- Portable sonic flow pump
 - Maintains ≥ 15 inches mercury downstream pressure
 - No additional critical orifice needed when used with BioSampler
 - Includes protective housing with handle, vacuum gauge, and valve
- Mounting rod secures BioSampler

Sampling with the BioSampler

The BioSampler is operated with a sonic flow pump, such as the Vac-U-Go Sampler or BioLite, that can maintain ≥ 15 inches mercury or 0.5 of an atmosphere of downstream pressure in the system. The BioSampler's three nozzles act as critical (sonic) orifices, each permitting 4.2 L/min of ambient air to pass through for a total flow rate of approximately 12.5 L/min.



Vac-U-Go BioSampler System

Description	SKC Inc. Cat. No.	SKC Ltd. Cat. No.
Complete BioSampler System, 115 V , includes 1 BioSampler, two 20-ml collection vessels with caps, 1 case with mounting rod, 1 ViaTrap* (120 ml), 1 Vac-U-Go pump, tubing, adapters and rotameter	225-9594	
Complete BioSampler System, 230 V , includes 1 BioSampler with 20-ml collection vessel, no cap, and 1 additional 20-ml collection vessel with cap, 1 mounting bracket, 1 BioLite Pump (CE marked, includes UK and Euro plugs), tubing, adapter, and rotameter		228-9610KB

* May not be suitable for PCR analysis

For a list of microbiological laboratories,
visit www.skinc.com/catalog/infopage.php?id=6000.

ABOUT

BioSampler Applications

Sample with the BioSampler to locate sources of biological contamination, identify/measure microorganism levels, evaluate effectiveness of control measures, or monitor bioaerosol releases. BioSampler is ideal for use in:

- Indoor air quality investigations
- Hospitals and veterinary clinics
- Agricultural dust studies
- Research
- Public buildings investigations
- Food handling industry
- Pulp and paper mills and wastewater treatment plants

Choose Your Pump



Vac-U-Go Pump
115 V



BioLite Pump
230 V, CE



More Information

www.skinc.com

Sterile Surface Swab Kit

For Biological Sampling



The Sterile Surface Swab Kit is ideal for determining the relative degree and type of biological contamination in an area. This non-destructive method can be used safely on most surfaces and is ideal for irregular surfaces such as air return grills. The rayon tip is inert, non-toxic, and permits good sample retrieval and adsorption. Each kit includes 10 sterile swabs in transport tubes and 10 templates (5 x 10 cm).

Sterile Surface Swab Kit*
Cat. No.....225-2402

Sterile Surface Swabs only,* pk/50
Cat. No.....225-2400

* Limited shelf-life

Stick-to-it Lift Tape

Surface Sampling of Biological Contaminants

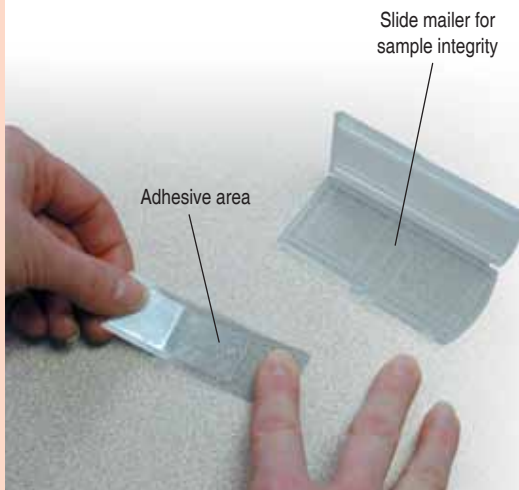

- ▶ Easy to use, inexpensive slides
- ▶ Consistent sample area for better data interpretation
- ▶ Flexible plastic for sampling irregular surfaces
- ▶ Individually serialized for sample identification

Stick-to-it flexible plastic microscope slides feature an adhesive area for easy sampling. Identify the sample area, press slide adhesive to the surface, place slide in provided mailer, and send it to a laboratory for analysis.

Description	Cat. No.
Stick-to-it, pk/10	225-9808
Stick-to-it, pk/50	225-9809

Carpet Sampling Cassettes

Collection of Fungal Spores in Carpeting

- ▶ Nozzle for easy sampling of irregular surfaces/carpeting
- ▶ Collect fungal spores in settled dust using a high flow pump

Designed for the collection of fungal spores from carpets and other dusty areas, the Carpet Sampling Cassette contains a 0.4- μ m pore size polycarbonate filter preloaded into a 37-mm cassette with an attached microvacuum nozzle. A high flow pump, such as the QuickTake 30 (see pages 26-27), is used for sample collection at a recommended flow rate of 10 L/min. Samples are sent to a laboratory for analysis of fungal spores.



Sample Time:	Varies
Sample Rate:	10 L/min (recommended)
Sample Pumps:	High-volume vacuum or QuickTake 30
Tubing:	1/4-inch ID and 3/8-inch ID

Description	Cat. No.	Qty.
Microvacuum Carpet Sampling Cassette , 37-mm, 0.4- μ m polycarbonate filter in banded styrene cassette with microvacuum nozzle	225-9542	ea
Carpet Sampling Cassette Kit includes 10 microvacuum carpet cassettes Cat. No. 225-9542, 10 x 10-cm disposable templates, Luer adapters, zip bags, and labels	225-9540	ea
Templates		
Disposable manila paper , 10 x 10 cm	225-2415	250
	225-2415A	10

For Microvacuum Cassettes for asbestos, see page 142.

VersaTrap Spore Trap Cassette

Traps Smaller Mold Spores Using Higher Flows

- ▶ **High collection efficiency from 5 to 30 L/min**
 - Captures *Aspergillus* and *Penicillium* mold spores as small as 1.5 µm at 30 L/min (see table below)
- ▶ **A standard collection method for mold spore count and genus identification**
- ▶ **Easy analysis — ASTM Method D7391-09**
 - Positioning notches and flat edges provide for easy alignment on microscope stage
 - Uniform, well-defined rectangular deposition
- ▶ **Optimized slide adhesive**
 - Optically clear and tested for superior adhesion
- ▶ **SureSeal certified leak-free cassettes for sample integrity**
- ▶ **Unique serial number on each cassette for sample traceability**



QuickTake 30 Pump
Ideal for Spore Traps
see pages 26-27



VersaTrap Spore Trap Cassettes provide the sampling versatility you need to capture mold spores and other particles ranging from 1.5 to 3.9 µm. Sampling is as easy as selecting the flow rate that will target the desired particle size (see table), calibrating a pump to the flow rate, and collecting the sample.

**High Flows + Low Cut-points + No Particle Bounce =
High Collection Efficiency**

Flow Rate (L/min)	VersaTrap 50% Cut-point (µm)
30	1.5
25	1.7
20	1.9
15	2.3
10	2.8
5	3.9

VersaTrap Design

The narrow slit inlet focuses particles toward the clear glass slide that is coated with a fully optimized sticky substrate. Targeted size particles are effectively held in a well-defined rectangular footprint. Each slide is encased in a SureSeal certified leak-free cassette to ensure sample integrity.

VersaTrap Makes Analysis Easy

- Slides easily removed from the cassette
- Positioning notches and flat edges for fast, easy alignment
- Well-defined rectangular footprint for accurate analysis using standard equipment
- Unique serial numbers for sample traceability

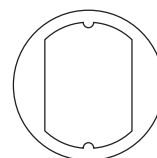

Description	Cat. No.	Qty.
VersaTrap Spore Trap Cassettes, 37 mm, limited shelf-life	225-9820	10
	225-9821	50
VersaTrap Wall Adapters, for sampling in wall cavities	225-9822	5

More Information
See www.astm.org for spore trap analysis method ASTM D 7391-09. Visit www.astm.org/COMMIT/SUBCOMMIT/D2208.htm for additional guidance on bioaerosol sampling.

Portable Instruments

Proven Performers from Technology Leaders



SKC is proud to offer innovative OEHS instruments from leading manufacturers such as Environmental Devices Corporation (EDC).

Portable Instruments for:

Particulates	127-130
HAZ-DUST IV	131
Indoor Environmental Quality (IEQ)	132-133
Ambient Air Quality	134-135
Formaldehyde	136



SPLIT2 Real-time Dust Monitor

Direct Read-out with Filter Option Using Any 2 L/min Pump

- **Economical, flexible, and direct reading**
- **Highly accurate**
 - ± 10% to NIOSH Method 0600 using SAE fine test dust
- **Reliable light-scattering technology**
- **Provides concurrent gravimetric sampling for different dust fractions when used with any 2 L/min sample pump**
 - Respirable dust with GS-3 Cyclone
 - Inhalable dust with IOM Sampler
 - Use gravimetric results to program monitor to correct for local dust characteristics
- **Compact and lightweight**
- **Programmable with easy-to-use 4-button keypad**
- **Easy-to-use software for flexible data management**
- **Alarms at hazardous concentrations**
- **DustComm Pro Software for downloading, basic trend analysis, and comprehensive graphical reporting**



CE



Attach to a pump and actively monitor dust levels while collecting a gravimetric sample. SKC recommends using the AirChek 52 pump. See pages 18-19.

Performance Profile

Sensing Range: 0.01 to 200 mg/m³

Particle Size Range: 0.1 to 100 µm

Data Storage: 21,500 data points

Data Display: Concentration in mg/m³ and TWA, MAX, MIN, and STEL

Run Time: ≥ 8 hours on rechargeable NiMH battery

Dimensions/Weight: 18 x 8 x 4.5 cm (7.1 x 3.1 x 1.8 in); 0.78 kg (1.7 lbs)

The flexible SPLIT2 Real-time Dust Monitor provides personal or area respirable or inhalable dust monitoring. SPLIT2 is a direct-reading passive dust monitor that can become an active monitor/sampler by combining it with a 2 L/min sample pump and GS-3 Cyclone or IOM sampling head for concurrent real-time dust monitoring and gravimetric dust sampling.

Description	SKC Inc. Cat. No.	SKC Ltd. Cat. No.
SPLIT2 Passive Monitor with accessories includes monitor, lapel bracket, zeroing accessory, calibration standard, computer cable, DustComm Pro Software, NiMH battery pack, AC charger/adapter, and carry case 110-240 V	770-300	
SPLIT2 Monitoring Kit with IOM (pump not included) includes all items in Cat. No. 770-300, IOM adapter, and IOM Sampler with cassette and transport clip Cat. No. 225-70A, see p. 108 for filters for IOM Sampler 110-240 V	770-300K1	
SPLIT2 Monitoring Kit with Cyclone (pump not included) includes all items in Cat. No. 770-300, GS-3 Cyclone adapter, and GS-3 Cyclone Cat. No. 225-103, see p. 110 for preloaded filters 110-240 V	770-300K2	
SPLIT2 Passive Monitoring Kit with "IOM-style" Sensor Head includes all items in Cat. No. 770-300 and one-piece IOM-style sensor head		770-300A

SPLIT2 Monitors and accessories are available separately. Contact SKC for more information.

EPAM-5000

Direct Readout Plus Filter Sample for EPA PM Criteria

- **Fast, easy setup**
- **Interchangeable impactors**
- **Highly sensitive and accurate**
 - Accuracy is $\pm 10\%$ filter gravimetric SAE fine dust test
- **Internal 1 to 4 L/min sample pump***
- **Unique aerodynamic particle-sizing real-time sensor**
 - Optional EPA FRM-style 47-mm filter cassette for gravimetric reference
- **High correlation to EPA PM10 methods and TEOM**
 - Ideal for saturation sampling
- **Wireless data transmission option transmits data up to 5 miles**
- **Ideal for ambient, environmental, and IAQ investigations**
- **DustComm Pro data analysis/reporting software included**
- **Wireless network software option available for Windows and Apple**



Performance Profile

Sensing Range: 0.001 to 20 and/or 0.01 to 200 mg/m³

Particle Size Range: 0.1 to 100 μm

Data Storage: 21,600 data points

Data Display: Concentration in mg/m³ and TWA, MAX, MIN, STEL, date, and time

Run Time: ≥ 24 hours on rechargeable battery; continuous on AC

Dimensions/Weight: 35.6 x 15.2 x 25.4 cm (14 x 6 x 10 in); 4.5 kg (10 lbs)

Description		Cat. No.
EPAM-5000 Monitor Kit with impactor (measures TSP without impactor), 110-240 V charger, DustComm Pro Software, computer cable, and manual, in a carry case	PM10	770-203
	PM2.5	770-202
	PM1.0	770-201
Accessories		
Calibration Standard		770-207
Filter Holder, 47 mm, for gravimetric sampling, <i>requires filter sold separately</i>		770-215
Impactors, interchangeable	10 μm	770-206
	2.5 μm	770-205
	1.0 μm	770-204
Filters for Gravimetric Analysis		
PTFE, [†] with PTFE support, 47 mm, 2.0- μm pore size, pk/50		225-2748
Quartz (Tissuquartz), 47-mm diameter, 432 μm thick, pk/25		225-1823

Requires calibration with equipment sold separately; see accessories

* Pump has a variable flow rate designed for use at 4 L/min to achieve proper size selection.

[†] Back pressure on PTFE filters can vary within the same lot.

For a lighter weight model with air station capabilities, see the EPAM-7500 on page 129.

Contact SKC for EPAM-5000 optional equipment and accessories including solar panels.

EPAM-7500

Portable Direct-reading PM Monitor and Air Station

- ▶ **Two sampling techniques for ambient and indoor particulate matter measurement**
 - Sensitive IR optical light scattering for real-time measurement and graphical representation of PM profile
 - 47-mm FRM-style filter holder for concurrent gravimetric sampling for cross-calibration and further PM speciation
- ▶ **Measures temperature and relative humidity**
- ▶ **Optional accessories include:**
 - Wireless modem
 - Solar panel
 - External audible alarm
 - Remote sampling probe
 - Heating element for high-humidity areas
 - Ultrasonic wind speed and direction measurement
 - Wind speed, wind direction, barometric pressure, heat index, and GPS in one lightweight sensor; no moving parts
- ▶ **Interchangeable single-jet impactors for PM10, PM2.5, PM1.0, or respirable**
 - Sampling inlets for PM10, PM2.5, and TSP included with instrument
- ▶ **Programmable**
- ▶ **Measurements displayed simultaneously on graphical color touch screen**
- ▶ **Internal 90-dB pulse alarm — user-selectable threshold**
- ▶ **Long-life Li-Ion battery**
- ▶ **Datalogging**
 - Digital outputs include serial (RS-232), removable CF card, USB Type A and B, and ethernet port
 - DustComm Pro PC analysis/reporting software included



Color touch screen



Interchangeable impactor



Only 3.2 kilograms!

Performance Profile

Sensing Range: 0.001 to 400 mg/m³

Particle Size Range: 0.1 to 100 μm

Data Storage: 50,000 data points

Data Display: Concentration in mg/m³ and TWA, MAX, MIN, STEL, date, time, temperature, and relative humidity

Run Time: ≥ 24 hours on rechargeable Li-Ion battery, continuous on AC or solar

Dimensions/Weight: 10.2 x 25.4 x 22.9 cm (4 x 10 x 9 in); 3.2 kg (7 lbs)

EPAM-7500 Applications

- Particulate indoor air quality investigations
- Evaluation of dust suppression/engineering controls
- Walk-through IAQ surveys
- Dust generation monitoring
- Quantifications of particle migration
- Hot spot location and identification
- Hazardous waste site and fence line monitoring
- Urban roadside air quality studies

Ordering Information

The HAZ-SCANNER EPAM-7500 is a configurable item. Contact SKC to custom order the EPAM-7500.

HAZ-DUST I Real-time Particulate Monitor Portable PM Survey Tool

- ▶ **Easy operation and instantaneous readings in mg/m³**
- ▶ **Highly sensitive — measures down to 0.01 mg/m³**
 - Monitors OSHA/NIOSH reference methods
- ▶ **Selectable dual measuring range feature**
 - Particulate concentration measurements between 0.01 and 20 mg/m³ and from 0.1 to 200 mg/m³
- ▶ **Easy-to-read digital display**
- ▶ **Low battery indicator**
- ▶ **Lightweight, rugged, and portable**
 - Optional tripod mounting
- ▶ **Optional datalogger with display and user-selectable alarm threshold**
- ▶ **Includes DustComm Pro Software for downloading, time vs. concentration profiling, and comprehensive graphical reporting**



The HAZ-DUST I is designed as a screening tool for IH, IAQ, and fenceline/perimeter monitoring of construction and other projects. HAZ-DUST I is factory calibrated for respirable particulate mass (50% cut-point of 4 µm) at ± 10% with SAE fine dust test. An alternative 10-µm cut-point calibration is available as a special order.

Performance Profile

Sensing Range: 0.01 to 200 mg/m³

Particle Size Range: 0.1 to 50 µm

Data Storage (with datalogger accessory): 21,500 data points

Data Display: Concentration in mg/m³

Run Time: > 8 hours on rechargeable NiMH battery

Dimensions/Weight: 23 x 7.6 x 3.8 cm (9 x 3 x 1.5 in); 0.6 kg (1.25 lbs)

Description		Cat. No.
HAZ-DUST I Monitor includes battery, charger, and carry case	110-240 V	770-1100
Accessories		
Datalogger , provides data storage, on-screen display of statistics, and user-selectable alarm threshold; includes analog signal cable, computer interface cable, and DustComm Pro Software, <i>printer required for hard copy reports</i>		770-113
Tripod Stand , adjustable stand and mounting plate for unattended monitoring		770-129
Calibration Standard , light-scattering device provides a constant value for verifying calibration		770-102
Zeroing Accessory , for pumping filtered air into the sensor for a zero reading in contaminated environments		770-130
Replacement Battery Pack , NiMH		770-108

Requires calibration with equipment sold separately; see Accessories

For a particulate monitor with an internal constant flow pump, see the HAZ-DUST IV on page 131.

HAZ-DUST IV Particulate Monitor

Personal Direct-reading Monitor with Concurrent Filter Sample

- ▶ Immediate display of particle concentration in mg/m³
- ▶ Interchangeable sampling heads match OSHA-defined size-selective regions of the lungs
 - Inhalable adapts to IOM Sampler
 - Thoracic impactor (included)
 - Respirable adapts to GS-3 Cyclone
- ▶ Highly accurate
 - ± 10% to filter gravimetric SAE fine test dust
 - NIST-traceable calibration
- ▶ Operate without impactor for total dust measurement by NIOSH Method 0500
- ▶ Internal adjustable sample pump — 1 to 3.3 L/min
- ▶ In-line cassette directly behind sensor for concurrent filter sampling
 - Use sample to correct data for local dust
- ▶ Audible alarm with adjustable threshold
- ▶ Small and lightweight with miniature sensor
- ▶ DustComm Pro Software for downloading, basic trend analysis, and comprehensive graphical reporting



Performance Profile

- Sensing Range:** 0.01 to 200 mg/m³
- Particle Size Range:** 0.1 to 100 µm
- Data Storage:** 21,500 data points
- Data Display:** Concentration in mg/m³ and TWA, MAX, MIN, STEL, date, and time
- Run Time:** > 8 hours on rechargeable NiMH battery
- Dimensions/Weight:** 14 x 8.3 x 7 cm (5.5 x 3.25 x 2.75 in); 0.68 kg (1.5 lbs)

Description	Cat. No.
HAZ-DUST IV Monitor includes monitor, thoracic impactor, in-line filter cassette, carry case, computer cable, battery charger, HAZ-DUST Media CD with instruction manual, and DustComm Pro Software 110-240 V	770-4004
HAZ-DUST IV Monitor Kit includes all items listed above plus GS Cyclone and adapter, IOM and adapter, calibration jar, and standard 110-240 V	770-4004K
Size-selective Sampling Heads	
Inhalable Sampling Head and Adapter , IOM Sampler, mounts on HAZ-DUST IV sensor	770-115A
Thoracic Sampling Head , mounts on inlet or HAZ-DUST IV sensor	770-4107
Respirable Sampling Head , GS-3 Cyclone, mounts on HAZ-DUST IV sensor	225-103
Adapter for Respirable Cyclone , required when using GS-3 Cyclone	770-313
Recommended Filters	
Quartz Filter , 37 mm, for gravimetric analysis and elemental chemical analysis of carbon-based compounds, pk/25	225-1822
PVC Filter , 37 mm, for economical general gravimetric analysis only, pk/100	225-5-37
Accessories	
Calibration Standard for Monitor , for verifying span and optical sensor performance	770-140
Calibration Jar , for calibrating and setting pump flow when using respirable impactor	225-112
Zeroing Accessory , for clean-air zeroing of sensor when using inhalable impactor	770-4202A
Zeroing Filter , for use with respirable and thoracic impactors	770-4102

Requires calibration with equipment sold separately; see accessories

AIR-AIDE Airborne Particulate Indoor Air Monitor

Portable Direct-reading Tool with Wireless Data Transmission

- ▶ High resolution and temperature stability
- ▶ Long-life air sample pump maintains accurate flow for particle separation
- ▶ Interchangeable size-selective impactors — choose PM10, PM2.5, PM1.0, or ISO respirable (4.0 µm)
- ▶ Built-in calibration factors for fine and coarse particulate matter
- ▶ NIST-traceable calibration
- ▶ Large data storage capacity
 - Run continuously up to 15 months without downloading
- ▶ On-screen programming of sampling and data storage parameters
- ▶ PC-based software included for downloading and graphing stored data
- ▶ User-defined audible alarm
- ▶ Location codes for tagging data
- ▶ Optional wireless data transmission to PC
- ▶ Includes DustComm Pro Software for graphical and statistical reporting



Performance Profile

Sensing Range: 0.001 to 20 mg/m³ (0.01 to 200 mg/m³ - optional)

Particle Size Range: 0.1 to 100 µm

Data Storage: 21,600 data points

Data Display: Concentration in mg/m³ and TWA, MAX, MIN, STEL, date, and time

Run Time: ≥ 10 hours on rechargeable NiMH battery; continuous on AC

Dimensions/Weight: 7.6 x 15.2 x 23 cm (3 x 6 x 9 in); 2.3 kg (5 lbs)

Description	Cat. No.
AIR-AIDE Monitor Kit includes monitor (0.001 to 20 mg/m ³), NiMH battery, charger/adaptor (100-240 V), rotameter, impactor sleeve for TSP, DustComm Pro Software, cable, and instruction manual	770-600
Accessories	
Impactor Grease	770-211
Size-selective Impactors	
PM10	770-606
PM2.5	770-605
PM1.0	770-604
Respirable	770-603

Wireless data transfer radio modems and other accessories are available. Contact SKC.

HAZ-SCANNER IEMS

Indoor Environmental Monitoring Station

- **Direct reading**
- **Measures and displays data for up to 14 critical indoor air quality parameters**
 - **Standard IEMS configuration** measures 5 parameters including PM10 or TSP particulates, CO₂, CO, temperature, and relative humidity
 - **Add up to 9 optional interchangeable sensors and/or IEMS-specific meters**
Choose from additional toxic gas sensors, PID for VOCs, or IEMS-specific meters for light intensity, sound/noise, atomic/nuclear radiation, ELF radiation, and air velocity
 - Available analog input port for alternative meter
- **Interchangeable size-selective impactors available for PM1.0, PM2.5, or PM4.0 (close approximation of respirable)**
- **In-line standard 37-mm or optional 25-mm gravimetric filter cassette provides concurrent filter sampling for chemical and biological analyses**
- **2 L/min internal sample pump**
- **Optional alarm indicator light and siren for user-defined threshold limits**
- **Removable handheld sensors for spot-checking remote areas**
- **Datalogging**
 - Real-time wireless data transmission and wireless network software options available
- **Easy-to-use graph and reporting software — compatible with PC and Mac**



Performance Profile

Sensing Range: 0.01 to 200 mg/m³ or 1 to 20,000 µg³

Particle Size Range: 0.1 to 100 µm

Data Storage: 36,000 data points

Data Display: MAX, MIN, TWA, STEL

Run Time: 8 hours on NiMH battery; continuous on AC

Dimensions/Weight: 17.8 x 10 x 28 cm (7 x 4 x 11 in); 2.7 kg (6 lbs)

HAZ-SCANNER IEMS Applications

- Snapshot air profiles at schools
- LEED Green Building certifications
- Job task analysis
- Complement to regulatory compliance
- IEQ assessment

For more information, go to www.skcinc.com and search "770-800."

Description	Cat. No.
HAZ-SCANNER IEMS includes NiMH battery and charger, HazComm Pro Software, cables, CD with instructions, and carry case	770-800

HAZ-SCANNER EPAS Environmental Perimeter Air Station

- ▶ **Measures/documents trace-level (ppb) gas, particulates, and meteorological parameters in real time to U.S. and EU directives**
 - Configure up to 14 sensors with true simultaneous PM2.5 and PM10 readings
- ▶ **Two options to customize your perimeter air station**
 - **Basic Kit** measures 3 parameters; add up to 11 additional sensors/meters
 - **Build Your Own System Kit:** Add up to 14 additional sensors/meters
 - **Use the checklist on page 135** to configure your EPAS before contacting SKC
 - Ask an SKC representative about wireless, network, and power options
- ▶ **Can be configured to monitor PM10 and PM2.5 simultaneously!**
- ▶ **Wireless networking and datalogging capabilities**
 - Network up to 8 EPAS units to one central PC or Mac; wireless network software option available
- ▶ **Easily portable and deployable**
- ▶ **Battery, AC, or solar operation**
- ▶ **Easy-to-use graph and reporting software compatible with PC and Mac**
 - Export .csv file
 - User-adjustable alarm thresholds
 - Serial output
 - Cell phone alerts

The portable HAZ-SCANNER EPAS environmental perimeter air station is easily deployed as an ambient air quality monitor to scan, measure, and document critical EPA criteria pollutants including nitrogen dioxide, carbon monoxide, sulfur dioxide, ozone, carbon dioxide, particulates, VOCs, and more. The EPAS provides direct readings in real time with datalogging capabilities. The graph and reporting software is compatible with PC and Mac. *Go to www.skcinc.com and search "EPAS".*



Measure up to 14 critical air parameters simultaneously with HAZ-SCANNER EPAS.

Ordering Information

The HAZ-SCANNER EPAS wireless environmental perimeter air station is a custom item. Build your own system to your specific applications with unique configurations and custom sensor calibrations. **Use the checklist on page 135 and contact SKC today.**

HAZ-SCANNER EPAS

Customize Your Perimeter Air Station

Create a HAZ-SCANNER EPAS to fit your applications. Use the convenient checklist below as a guide *before* contacting an SKC representative to build your EPAS today.

Start with:

EPAS Basic Kit

- ✓ PM10 or TSP particulates
- ✓ Nitrogen dioxide
- ✓ Carbon monoxide
- ✓ Temperature
- ✓ Relative Humidity

Add up to 9 sensors/meters

or

EPAS Build Your Own System Kit

Add up to 14 sensors/meters

Choose 1 additional particulate sensor for Basic Kit (optional). Choose up to 2 for Build Your Own.

- PM1.0
- PM2.5
- PM10

Choose up to 6 interchangeable gas sensors (8 for Build Your Own).*

- | | |
|---------------------------------------------------------------|------------------------------------------------------------|
| <input type="checkbox"/> Ammonia (GSS) | <input type="checkbox"/> Hydrogen sulfide (EC) |
| <input type="checkbox"/> Carbon dioxide (NDIR) | <input type="checkbox"/> Nitric oxide (EC) |
| <input type="checkbox"/> Carbon monoxide (EC) | <input type="checkbox"/> Nitrogen dioxide (EC) |
| <input type="checkbox"/> Chlorine (EC) | <input type="checkbox"/> Oxygen (EC) |
| <input type="checkbox"/> Ethylene oxide (EC) | <input type="checkbox"/> Ozone (metal oxide semiconductor) |
| <input type="checkbox"/> Hydrocarbon: methane-specific (NDIR) | <input type="checkbox"/> Phosphine (EC) |
| <input type="checkbox"/> Hydrocarbons: non-methane (NDIR) | <input type="checkbox"/> Sulfur dioxide (EC) |
| <input type="checkbox"/> Hydrogen chloride (EC) | <input type="checkbox"/> VOCs (PID) |
| <input type="checkbox"/> Hydrogen cyanide (EC) | |

Choose up to 4 EPAS-specific optional meters or meteorological sensors.*

- | | |
|-----------------------------------------------------------------------|-----------------------------------------------------------------------|
| <input type="checkbox"/> Temperature | <input type="checkbox"/> Relative humidity (RH) |
| <input type="checkbox"/> Rain gauge (tipping bucket) | <input type="checkbox"/> Dew point temperature (software calculation) |
| <input type="checkbox"/> Solar radiance (photodiode) | <input type="checkbox"/> Sound/Noise (Type 2 SLM) |
| <input type="checkbox"/> Barometric pressure (piezo resistive)* | <input type="checkbox"/> Atomic/Nuclear radiation (Geiger counter) |
| <input type="checkbox"/> Wind speed/direction (3-cup anemometer/vane) | |

* Barometric pressure sensor applies to both the gas sensor count and the meter count.

Contact your SKC representative today for a quote on your custom configured station!

For EPAS instrument, sensor, and meter specifications, visit www.skcinc.com and search "EPAS."



ABOUT

Formaldehyde Multimode Monitor Technology

The reusable* sensor cartridge contains a porous glass insert treated with β -diketone. Formaldehyde diffuses from an area of high concentration (the air) to an area of low concentration (the sensor cartridge). A chemical reaction occurs between the formaldehyde and the β -diketone in the cartridge, resulting in a yellowing of the porous glass. This reaction is measured by a photoelectric photometer inside the base unit with accurate readings to < 20 ppb formaldehyde without significant cross-sensitivity from typical background compounds.

New!

Formaldehyde Multimode Monitor

Passive, Short-term, and Continuous Formaldehyde Measurement

- ▶ **Highly accurate**
- ▶ **Detection range: 20 to 1000 ppb**
- ▶ **Accuracy is $\pm 10\%$ at 40, 80, and 160 ppb**
- ▶ **Lightweight, portable base unit**
 - Uses photoelectric photometry to read absorbance change in sensor cartridge
 - Automatically re-zeros between readings
- ▶ **Reusable* colorimetric sensor cartridge**
- ▶ **Displays concentration in ppb or $\mu\text{g}/\text{m}^3$**
- ▶ **One-week continuous operation from alkaline batteries**
 - AC adapter for extended measuring periods
- ▶ **Power save feature**
- ▶ **Datalogging – download data to PC using included USB cable and Data Filing Software**
 - Generate graphical reports
- ▶ **Multiple monitoring configurations**
 - Hang sensor for stand-alone passive
 - Short-term (30-minute) passive
 - Continuous passive (reads every 30 minutes)



Base unit



Insert sensor cartridge



Hang sensor cartridges for passive measurement in multiple locations.



Mount base unit with sensor cartridge on included tripod for short-term (30-minute) or continuous measurements.



More Information

www.skinc.com

Search "formaldehyde monitor"

Description	Cat. No.
Formaldehyde Multimode Monitor includes base unit with 5 sensor cartridges, [†] USB cable, Data Filing Software, two AA-size alkaline batteries, AC adapter, tripod, zero filter, and carry case	780-001
Replacement Formaldehyde Sensor Cartridges[†]	780-002
pk/5	780-003
pk/10	

* Number of reuses is based on the length of exposure time and formaldehyde concentration during each measurement period.

† Limited shelf-life

SKC Surface/Dermal Sampling

A First Step in Hazard Identification

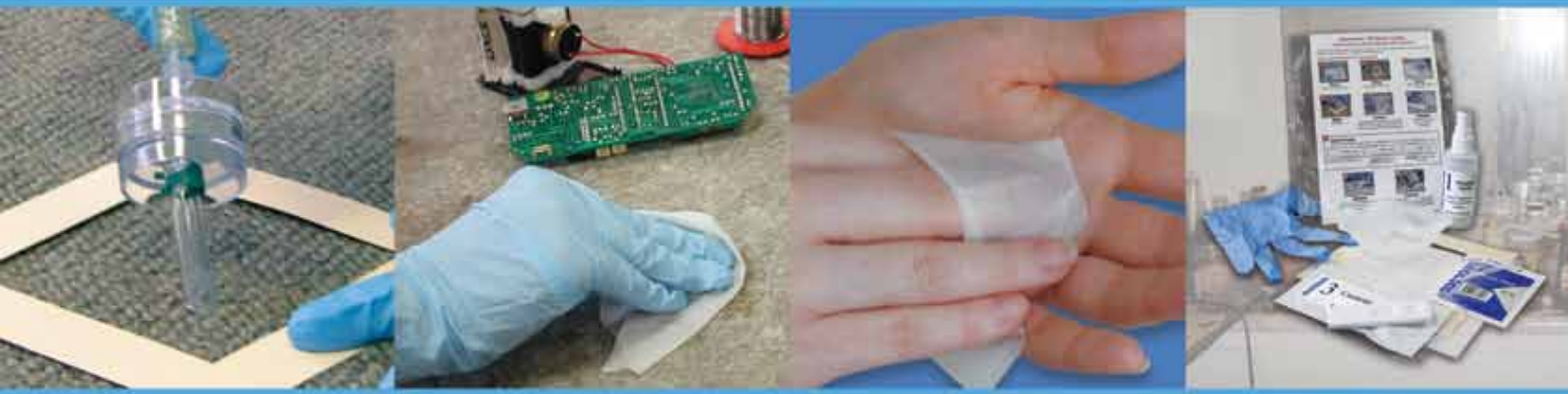

Sampling Kits for:

Lead	pages 138-140
Metals	140
Methamphetamine Residue	141
Fungal Spores	142
Asbestos	142

Tech Tips

► CDC-NIOSH has released *Effects of Skin Contact with Chemicals: What a Worker Should Know*, a technical resource on dermal exposures. Visit www.cdc.gov/niosh/docs/2011-199/ to download the pdf.

Lead Testing in 3 Easy Steps

Step 1

Crush and shake

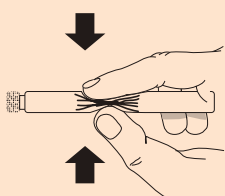

Step 2

Squeeze

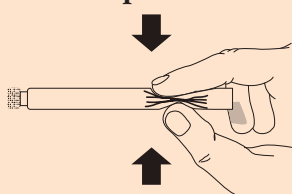

Step 3

Rub

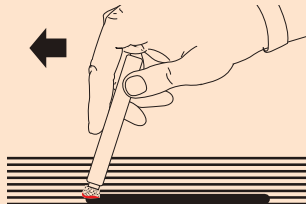

RED MEANS LEAD!

LeadCheck Sampling Swabs

Fast On-the-spot Lead Screening

- **Fast and easy to use**
 - 3 easy steps
 - No instruments
 - Results in minutes
- **Convenient**
 - Use almost anywhere (except skin)
- **Inexpensive**
 - No instruments or analysis required
- **Easy to interpret**
 - Positive confirmation procedures in each kit
- **Sensitive lead kit**
 - Detects lead on 96.6% of surfaces tested
- **EPA-recognized instant lead detection test**



The LeadCheck Surface Sample Kit includes self-contained sampling swabs with all materials required for the rapid screening of lead on surfaces and in liquids. In April 2010, the EPA mandated testing for lead and use of lead-safe practices by contractors renovating, repairing, or painting structures built before 1978 (EPA RRP). The EPA has recognized the LeadCheck Kit as a tool to aid contractors in complying with the new mandate. LeadCheck swabs are easy to use: crush, shake, swab, and read the result. RED MEANS LEAD.



Simple, Inexpensive Test Kit Receives EPA Recognition

After rigorous testing, LeadCheck Swabs are now recognized by the EPA for use on drywall and plaster as well as on painted wood and metal. LeadCheck Kits provide a quick and simple way for certified renovators to test for lead and take steps toward compliance under the Renovation, Repair, and Painting Rule (RRP). Visit www.youtube.com and search for "LeadCheck" for instructional videos on using LeadCheck Swabs on drywall, plaster, painted wood, and metal surfaces.

Hazard	Sensitivity		Interferences	Cat. No.	Qty.
	Solid Surface (µg)	Liquid (ppm)			
Lead (Pb)	< 1	2	No other metals react to give the same color response	225-2404 225-2404A	8 16

For safe lead detection on skin, see Full Disclosure on page 139.

FULL DISCLOSURE

Instant Detection of Lead on Skin and Surfaces

- **Completely safe surface and skin testing**
 - Reagents never touch the test surface
 - Testing skin allows direct evaluation of lead exposure
 - Suitable for testing both flat and irregular surfaces
- **Immediate color change — instant results**
 - Identifies lead contamination at $\geq 18 \mu\text{g}$
 - Wipes can be sent to a lab for quantitative results
- **Easy to use**
- **Developed, tested, and patented* by CDC-NIOSH**
- **Meets NIOSH Method 9105 for Lead in Dust Wipes**



Full Disclosure[®] wipe sampling provides instant detection of lead on skin and surfaces. Unlike other lead sampling methods, Full Disclosure lead wipes are completely safe to use because no chemical touches the test site. Full Disclosure lead wipes are ideal for determining the effectiveness of lead removal, educating workers in industries where lead is an occupational hazard, spot-checking lead-contaminated work surfaces and break rooms, and helping to eliminate lead as a take-home toxic. Each Full Disclosure Kit contains everything needed to detect lead at or above 18 μg on skin and surfaces.

Description	Cat. No.
Full Disclosure Kit [#] includes 11 pairs nitrile gloves, 10 wipes, [‡] Disclosing SR powder, extraction solution, deionized water, 10 sheets of waxed paper, and instructions	550-001
Full Disclosure Kit [#] for Quantitative Analysis [†] includes all items in above kit, 10 sample collection bottles with labels, and 10 disposable templates	550-002

* U.S. Patent No. 6,248,593

[†] Not designed for detecting lead in paint and paint chips, on painted surfaces, or embedded in material such as plastic; not suitable for lead chromate

[‡] Wipes conform to ASTM E1792.

[#] Limited shelf-life

See Tech Note 1485 at www.skcinc.com for more information.

Three Easy Steps to Full Disclosure of Lead

Step 1 Prepare the Solution



Step 2 Take the Sample



Step 3 Read the Results



Yellow to Orange = lead < 18 μg



Pink to Red = lead $\geq 18 \mu\text{g}$



Data Interpretation Lead on Surfaces

- ▶ Lead is considered a hazard at surface levels of:
 - $\geq 40 \mu\text{g}/\text{ft}^2$ on floors
 - $\geq 250 \mu\text{g}/\text{ft}^2$ on interior window sills

Source: TSCA Section 403 Residential Lead Standards (January 5, 2001 Federal Register)



Smear Tabs

Low-ash, acid-hardened paper Smear Tabs are designed for collecting samples on surfaces where dust and chemicals have settled. SKC Smear Tabs are specified in OSHA ID-145 for wipe sampling of particulate mercury, $\text{pk}/100$

Cat. No.225-24

Ghost Wipes Sample Lead and Beryllium on Surfaces

- ▶ Robust for wiping even rough surfaces
- ▶ Readily and completely digested in hot water or acid solution
- ▶ Meet specifications for sampling lead and beryllium
 - All ASTM E1792 specifications as required by U.S. EPA
 - AIHA policy on sampling materials for lead in surface dust
 - OSHA Method ID-125G, Addendum B
 - ASTM D7707 for beryllium
 - NIOSH 9102 Elements on Wipes, including nanomaterial

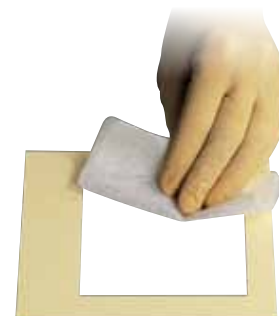

Robust Ghost Wipes hold together even when used on the roughest surfaces. In the lab, Ghost Wipes readily and completely dissolve during digestion for maximum recovery of target analyte(s). Ghost Wipes earn their name by dissolving so completely that there is no messy fibrous material to clog the sample uptake capillary or nebulizer. The Wipe Sample Test Kit below contains Ghost Wipes.

See below for ordering information and templates.

Wipe Sample Test Kit Supplies for OSHA Wipe Tests

- ▶ Contains materials to sample surface metals, pesticides, amines, radionuclides, corrosives, and dust
- ▶ Assists in evaluating hazard control effectiveness and cleaning regimens
- ▶ All you need for OSHA wipe sample methods (solvents not included)

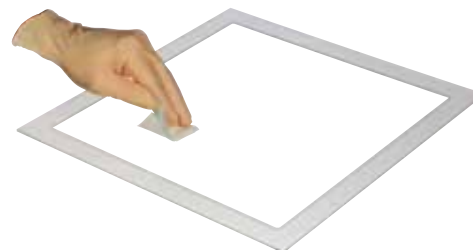

The Wipe Sample Test Kit provides the necessary supplies to sample surfaces for toxic materials that can gain entry into the body via ingestion or skin absorption. Each kit includes paper and glass fiber filters, sterile sample bags, latex gloves, cotton swabs, pH paper, cover slips, 25 Ghost Wipes for lead and other metals, 72 microslides, 20 sample containers, 3 dropper bottles, 25 paper templates (10 x 10 cm), marking pen, masking tape, clear tape, stainless steel forceps, and carry case. *Solvents are not included.*

Description	Cat. No.	Qty.
Ghost Wipes , moistened with deionized water, individually sealed packets, require 10 x 10-cm (3.9 x 3.9-inch) template listed below	225-2414	200
	225-2413	1000
Wipe Sample Test Kit , solvents are not included	225-2401A	ea
Templates		
Disposable manila paper , 10 x 10 cm (3.9 x 3.9 inches)	225-2415	250
	225-2415A	10
Disposable manila paper , 30.5 x 30.5 cm (1 x 1 foot)	225-2416	250
	225-2416A	10

For metal in air determinations using NIOSH 7300, see page 89 for Solu-CAPs.

MethChek Immunoassay Wipe Kits

Sensitive Pre and Post-remediation Kits for ng-Level Detection

- ▶ **Fast, reliable on-site results**
- ▶ **Indicates meth residue at ≥ 50 nanograms**
 - Kits also available for indication at 100, 500, and 1500 nanograms
- ▶ **Semiquantitative results**
- ▶ **Save money with multiple-test kits**
- ▶ **No shipping or lab fees**
- ▶ **Lightweight, portable**
- ▶ **Developed by CDC-NIOSH**
- ▶ **Safe for use on many surfaces, including animal fur**



Make informed decisions in the field!

MethChek® Kits provide on-the-spot semiquantitative assessment of meth residue at the lowest state cleanup guideline of 50 ng/100 cm² (100, 500, and 1500-ng sensitivities also available). Simply wipe, extract, and read results. MethChek is an ideal post-assessment tool to determine the need for further cleaning before sending cleanup crews away.

All-in-one MethChek Kits

MethChek Kits contain the following:

- Gauze pads or swabs
- Trays
- Templates
- Gloves
- Syringes (except MethChek 50)
- Pipettes
- Reagents
- Detection cartridges
- Bags
- Instructions and SDS

Description	Lower Limit of ID		Cat. No.	Tests
	$\mu\text{g}/100 \text{ cm}^2$	ng		
MethChek 50	0.05	50	560-004	12
			560-004A	1
			560-004B	3
MethChek 100	0.1	100	560-003	12
			560-003A	1
			560-003B	3
MethChek 500	0.5	500	560-002	12
			560-002A	1
			560-002B	3
MethChek 1500	1.5	1500	560-005	12
			560-005B	3

1 Wipe

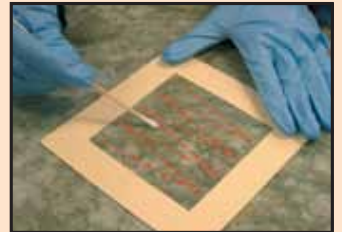

2 Extract



3 Read Results



Positive result with MethChek Kit



For MethChek instructional video, visit www.skcinc.com and click Technical Library, Presentations.

©Mikael Karlsson/Arresting Images. All Rights Reserved.



Sample Pumps
see pages 26-29

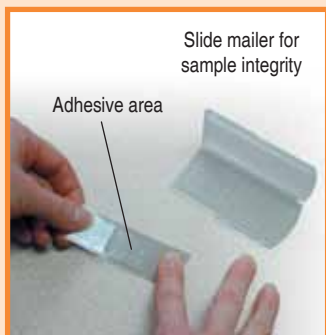

Stick-to-it Lift Tape

- Easy-to-use, inexpensive slides
- Consistent sample area for better data interpretation
- Flexible plastic for sampling irregular surfaces
- Individually serialized for sample identification

Stick-to-it flexible plastic microscope slides feature an adhesive area for easy sampling. Identify the sample area, press slide adhesive to the surface, place slide in provided mailer, and send to a laboratory for analysis.

Cat. No. 225-9808.....pk/10
Cat. No. 225-9809.....pk/50



Microvacuum Cassettes for Surface Sampling

Efficient Collection of Asbestos or Fungal Spores

- ▶ Nozzle for easy sampling on irregular surfaces/carpeting
- ▶ Collect contaminants in settled dust using a high flow pump

Collect fungal spores or asbestos from carpets and other dusty areas using SKC Microvacuum Cassettes. SKC Microvacuum Cassettes are available with an MCE or polycarbonate filter and feature a microvacuum nozzle for sampling settled dust on surfaces as specified in ASTM Methods D5755 and D5756.



Microvacuum Cassettes for Asbestos or Fungal Spores				
Dia. (mm)	Filter Specifications	Cassette Description	Cat. No.	Qty.
25	0.45 µm MCE, BestChek, for TEM analysis	Carbon-filled polypropylene with cowl and nozzle	 225-322	ea
37	0.45 µm MCE, for TEM analysis	Styrene (non-conductive) with nozzle	 225-9543	ea
37	0.4 µm polycarbonate	Styrene (non-conductive) with nozzle	 225-9542	ea
Templates	Disposable manila paper, 10 x 10 cm (3.9 x 3.9 inches)		225-2415	250
			225-2415A	10
	Disposable manila paper, 30.5 x 30.5 cm (1 x 1 foot)		225-2416	250
			225-2416A	10
Carpet Sampling Kit for Asbestos and Fungal Spores includes 10 microvacuum carpet cassettes Cat. No. 225-9542, 10 x 10-cm (3.9 x 3.9-inch) disposable templates, Luer adapters, zip bags, and labels				225-9540 ea

Sterile Surface Swab Kit

For Biological Sampling

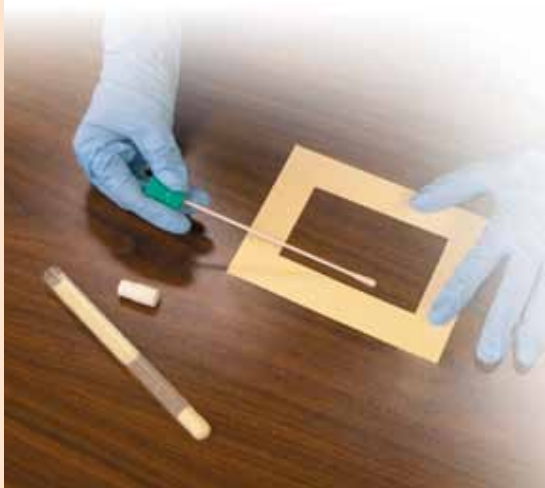

The Surface Swab Kit is ideal for determining the relative degree and type of biological contamination in an area. This non-destructive method can be used safely on most surfaces and is ideal for irregular surfaces such as air return grills. The rayon tip is inert, non-toxic, and permits good sample retrieval and adsorption. Each kit includes 10 sterile swabs in transport tubes and ten 5 x 10-cm (1.97 x 3.94-inch) templates.

Description	Cat. No.	Qty.
Surface Swab Kit*	225-2402	ea
Surface Swabs Only*	225-2400	50

* Limited shelf-life

SKC Active Air Sampling Guide

The Essential Reference – In Print, Online, and Mobile



Welcome to the SKC Active Air Sampling Guide! Sampling information based on OSHA/NIOSH/ASTM/EPA/HSE methods for over 2500 compounds is now at your fingertips.

- **Easy to use**
 - Locate the chemical hazard of interest in the alphabetic listing to view:
 - ▶ Agency reference method
 - ▶ Method sampling parameters (agency standard, volume, flow rate, and time)
 - ▶ Analytical method
 - ▶ Collecting equipment listing and page reference
 - ▶ Reference number for online access to method summaries
- **Environmental methods are displayed in blue**
- **For Passive Samplers, see pages 68-86**
- **Available anywhere you are**
 - ▶ **Print:** See pages 144-211 in this catalog
 - ▶ **Online:** Access searchable guides at www.skcinc.com

Introduction

This guide includes most hazardous substances, including their current Workplace Exposure Limits at the time of printing (where applicable). For the most up-to-date version of this guide, please visit our website at www.skcltd.com. For a full list of Workplace Exposure Limits, please consult EH40, available from HSE books or www.hse.gov.uk. This guide should not be used as an alternative to obtaining a copy of EH40 and reading the full supplementary data it contains.

The following statements are taken directly from EH40 Workplace Exposure Limits.

Workplace Exposure Limits (WELs)

WELs are British occupational exposure limits and are set in order to help protect the health of workers. WELs are concentrations of hazardous substances in the air, averaged over a specified period of time, referred to as a time-weighted average (TWA). Two time periods are used: long-term (8 hours) and short-term (15 minutes).

Short-term exposure limits (STELs) are set to help prevent effects such as eye irritation, which may occur following exposure for a few minutes.

WELs and the Control of Substances Hazardous to Health Regulations 2002 (COSHH)

Substances that have been assigned a WEL are subject to the requirements of COSHH. These regulations require employers to prevent or control exposure to hazardous substances. For further information, go to www.hse.gov.uk/coshh. Under COSHH, control is defined as adequate only if a) the

principles of good control practice are applied, b) any WEL is not exceeded, and c) exposure to asthmagens, carcinogens, and mutagens are reduced as low as is reasonably practicable.

The absence of a substance from the list of WELs does not indicate that it is safe. For these substances, exposure should be controlled to a level to which nearly all the working population could be exposed, day after day at work, without any adverse effects on health.

As part of the assessment required under regulation 6 of COSHH, employers should determine their own working practices and in-house standards for control of exposure. In some cases, there may be sufficient information available for employers to set an 'in-house' working standard, e.g., from manufacturers and suppliers of the substances, publications of industry associations, occupational medicine and hygiene journals, and other agencies such as NIOSH and OSHA.

Chemical Hazard	Agency Reference	SAMPLING								Analytical Method	SKC Collecting Equipment and Page No.			
		WEL		Vol. (liter)		Rate (ml/min)		Time						
		TWA (ppm)	STEL (ppm)	TWA	STEL	TWA	STEL	TWA (hr)	STEL (min)					
Acetaldehyde	MDHS 102	20 ppm (37 mg/m ³)	50 ppm (92 mg/m ³)			1000		8	15	HPLC	CF/CST 225-9003 or ST 226-120	ST 226-119 or 40		
Acetaldehyde	MDHS 102	20 ppm (37 mg/m ³)	50 ppm (92 mg/m ³)	diffusive	diffusive	diffusive	diffusive			HPLC	PS 500-100	84		
Acetic acid	MDHS 96			24		50		8		GC-FID	ST 226-01	38		
Acetic anhydride	OSHA 102	0.5 ppm (2.5 mg/m ³)	2 ppm (10 mg/m ³)	7.5	7.5	50	500	2.5	15	GC-NPD	CF/CST 225-9010	64	C/HLD 225-1	102
Acetic anhydride	OSHA 82	0.5 ppm (2.5 mg/m ³)	2 ppm (10 mg/m ³)	0.75		50		15 min		GC-NPD	CF/CST 225-9009		C/HLD 225-1	102
Acetone	MDHS 88	500 pm (1210 mg/m ³)	1500 ppm (3620 mg/m ³)	diffusive	diffusive	diffusive	diffusive			GC-FID	PS 575-002	75		
Acetone	MDHS 96	500 pm (1210 mg/m ³)	1500 ppm (3620 mg/m ³)	2	0.75	20	50	100 min	15	GC-FID	ST 226-01	38		
Acetonitrile	MDHS 88	40 ppm (68 mg/m ³)	60 ppm (102 mg/m ³)	diffusive	diffusive	diffusive	diffusive			GC-FID	PS 575-002	75		
Acetonitrile	MDHS 96	40 ppm (68 mg/m ³)	60 ppm (102 mg/m ³)	10		20 (50)		8 (3.3)		GC-FID	ST 226-09	38		
o-Acetylsalicylic acid	MDHS 14/4	5 mg/m ³		120		2000		8		GR	IOM 225-70A	108	FLT 225-58F	96
Acrolein (acrylaldehyde)	NIOSH 2501	0.1 ppm (0.23 mg/m ³)	0.3 ppm (0.7 mg/m ³)	24	3	50	200	8	15	GC-NPD	ST 226-118	40		
Acrolein (acrylaldehyde)	OSHA 52	0.1 ppm (0.23 mg/m ³)		48	3	100	200	8	15	GC-NPD	ST 226-117	40		
Acrylamide	MDHS 57/2	0.3 mg/m ³		50	3	100	200	8	15	HPLC-UV	IMP 225-36-1	67	IT 225-22	67
Acrylonitrile	MDHS 88	2 ppm (4.4 mg/m ³)		diffusive	diffusive	diffusive	diffusive			GC-FID	PS 575-001	75		
Acrylonitrile	MDHS 96	2 ppm (4.4 mg/m ³)		24		50		8		GC-FID	ST 226-01	38		
Allyl alcohol	MDHS 88	2 ppm (4.8 mg/m ³)	4 ppm (9.7 mg/m ³)	diffusive	diffusive	diffusive	diffusive			GC-FID	PS 575-002	75		
Allyl alcohol	MDHS 96	2 ppm (4.8 mg/m ³)	4 ppm (9.7 mg/m ³)	10	3	20 (50)	200	8 (3.3)	15	GC-FID	ST 226-01	38		
Aluminium alkyl compounds	OSHA ID-121	2 ppm		960		2000		8		AAS	F/CST 225-3-01	88	C/HLD 225-1	102
Aluminium metal (inhalable dust)	MDHS 14/4	10 mg/m ³		960		2000		8		GR	IOM 225-70A	108	FLT 225-58F	96
Aluminium metal (respirable dust)	MDHS 14/4	4 mg/m ³		1056		2200		8		GR	IOM 225-70A or CYC 225-69	108	FOAM 225-772 or 111 FLT 225-58F	96
Aluminium oxides (inhalable dust)	MDHS 14/4	10 mg/m ³		960		2000		8		GR	IOM 225-70A	108	FLT 225-58F	96
Aluminium oxides (respirable dust)	MDHS 14/4	4 mg/m ³		1056		2000 (2200)		8		GR	IOM 225-70A or CYC 225-69	108	FOAM 225-772 or 111 FLT 225-58F	96
Aluminium salts, soluble	OSHA ID-121	2 mg/m ³		960		2000		8		AA or AES	F/CST 225-3-01	88	C/HLD 225-1	102
2-Aminoethanol	MDHS 96	1 ppm (2.5 mg/m ³)	3 ppm (7.6 mg/m ³)	10		20		8		GC-FID	ST 226-10-04	38		
Ammonia, anhydrous	NIOSH 6015	25 ppm (18 mg/m ³)	35 ppm (25 mg/m ³)	72	3	150	200	8	15	VAS	ST 226-10-06	38	F/CST 225-3-01	88
Ammonia, anhydrous	NIOSH 6016	25 ppm (18 mg/m ³)	35 ppm (25 mg/m ³)	48	3	100	200	8	15	IC	ST 226-10-06	38	F/CST 225-3-01	88
Ammonium chloride (fume)	MDHS 14/4	10 mg/m ³	20 mg/m ³	960	30	2000	2000	8	15	GR, IC-ECN	IOM 225-70A	108	FLT 225-1930	93
Ammonium sulphamate	MDHS 14/4	10 mg/m ³	20 mg/m ³	960	30	2000	2000	8	15	GR	IOM 225-70A	108	FLT 225-1930	93
Aniline	MDHS 96	1 ppm (4 mg/m ³)		200		20	200		100	GC-FID	ST 226-10	38		
Antimony & compounds (as Sb)	MDHS 91/2	0.5 mg/m ³				2000		8		XRF	IOM 225-70A	108	FLT 225-1930	88
p-Aramid respirable fibres	MDHS 87	0.5 fibres/ml		Refer to method						PCM	FLT/CL 225-54A	102	FLT 225-1913	88
Aromatic carboxylic acid anhydrides (see individual compounds)	MDHS 62/2									HPLC	IOM 225-70A or ST 226-35	108	FLT 225-58F	96

See page 212 for abbreviations.

Chemical Hazard	Agency Reference	SAMPLING								Analytical Method	SKC Collecting Equipment and Page No.			
		WEL		Vol. (liter)		Rate (ml/min)		Time						
		TWA (ppm)	STEL (ppm)	TWA	STEL	TWA	STEL	TWA (hr)	STEL (min)					
Arsenic & compounds (except arsine) as As	MDHS 91/2	0.1 mg/m ³		240		2000		2		XRF	IOM 225-70A	108 FLT	225-1930	88
Arsine	NIOSH 6001	0.05 ppm (0.16 mg/m ³)		10	3	20	200	8	15	AA-GF	ST 226-01		38	
Asbestos (chrysotile alone)	MDHS See HSG 248		0.1	240	40	1000	4000	4	10	PCM	FLT/CL 225-54A	102 FLT	225-60F	or 88
Asbestos, with crocidolite/amosite/mixtures	MDHS See HSG 248		0.1	240	40	1000	4000	4	10	PCM	FLT/CL 225-54A	102 FLT	225-60F	or 88
Asphalt (petroleum fumes)	NIOSH 5042	5 mg/m ³	10 mg/m ³	360	60	1000	4000	6	15	GR	FLT 225-27-07	94 SP	225-27	103
Azodicarbonamide	MDHS 92/2	1 mg/m ³	3 mg/m ³	960	30	2000	2000	8	15	HPLC	IOM 225-79A	108 FLT	225-58F	96
Barium compounds (soluble) (as Ba)	MDHS 91/2	0.5 mg/m ³		960		2000		8		XRF	IOM 225-70A	108 FLT	225-1930	88
Barium sulphate (inhalable dust)	MDHS 14/4	10 mg/m ³		960		2000		8		GR	IOM 225-70A	108 FLT	225-58F	96
Barium sulphate (respirable dust)	MDHS 14/4	4 mg/m ³		1056		2200		8		GR	CYC 225-69	111 FLT	225-58F	96
Benzene	MDHS 72	1 ppm (3.25mg/m ³)		2.5		5		8		TD, GC	ST 226-357		42	
Benzene	MDHS 80	1 ppm (3.25mg/m ³)		24		50		8		GC-ECD	ST 226-357		42	
Benzene	MDHS 88	1 ppm (3.25mg/m ³)		diffusive	diffusive	diffusive	diffusive			GC-FID	PS 575-001		75	
Benzene	MDHS 96	1 ppm (3.25mg/m ³)		10	3	20	200	8	15	GC-FID	ST 226-01		38	
Benzyl butyl phthalate	MDHS 96	5 mg/m ³		50		10		8		GC-FID	ST 226-35	√	38	
Benzyl chloride	MDHS 88	0.5 ppm (2.6 mg/m ³)	1.5 ppm (7.9 mg/m ³)	diffusive	diffusive	diffusive	diffusive			GC-FID	PS 575-001		75	
Benzyl chloride	MDHS 96	0.5 ppm (2.6 mg/m ³)	1.5 ppm (7.9 mg/m ³)	10	3	20	200	8	15	GC-FID	ST 226-01		38	
Beryllium & compounds (as Be)	Contact SKC	0.002 mg/m ³		960	120	2000	2000	8	60	AA	IOM 225-70A	108 FLT	225-1930	88
Bisphenol A	MDHS 14/4	10 mg/m ³		960		2000		8		GR	IOM 225-70A	108 FLT	225-58F	96
Boman-2-one	MDHS 88	2 ppm (13 mg/m ³)	3 ppm (19 mg/m ³)	diffusive	diffusive	diffusive	diffusive			GC-FID	PS 575-002		75	
Boman-2-one	MDHS 96	2 ppm (13 mg/m ³)	3 ppm (19 mg/m ³)	10		20(50)		8(3.3)		GC-FID	ST 226-01		38	
Boron tribromide	OSHA CSI		1 ppm (10 mg/m ³)		5		1000		5	IC	IIMP 225-36-2	or IMP	225-36-5	67
Bromacil (ISO)	OSHA CSI	1 ppm (11 mg/m ³)	2 ppm (22 mg/m ³)	50		1000		50		HPLC-UV	IIMP 225-36-1	67 IT	225-22	67
Bromine	NIOSH 6011	0.1 ppm (0.66 mg/m ³)	0.2 ppm (1.3 mg/m ³)	250	15	1000	1000	4	15	IC	CF/CST 225-9006	64 C/ILD	225-1	102
Bromomethane	OSHA PV2040	5 ppm (20 mg/m ³)	15 ppm (59 mg/m ³)	3		50		1		GC-FID	ST 226-83 §		40	
1,3-Butadiene	MDHS 53/2	10 ppm (22 mg/m ³)		5	7.5	10	500	8	15	GC-FID	ST 900 mg 13X MOLECULAR SIEVE			
1,3-Butadiene	MDHS 80	10 ppm (22 mg/m ³)		24		50		8		GC-ECD	ST 226-358		42	
1,3-Butadiene	MDHS 88	10 ppm (22 mg/m ³)		diffusive	diffusive	diffusive	diffusive	8	15	GC-FID	PS 575-001		75	
1,3-Butadiene	MDHS 96	10 ppm (22 mg/m ³)		10		20		8		GC-FID	ST 226-09		38	
Butan-1-ol	MDHS 72		50 ppm (154 mg/m ³)	24		50		8		TD, GC	ST 226-358		42	
Butan-1-ol	MDHS 80		50 ppm (154 mg/m ³)	24		50		8		GC-ECD	ST 226-358		42	
Butan-1-ol	MDHS 88		50 ppm (154 mg/m ³)	diffusive	diffusive	diffusive	diffusive			GC-FID	PS 575-002		75	
Butan-1-ol	MDHS 96		50 ppm (154 mg/m ³)	10	3	20-50	200	8	15	GC-FID	ST 226-01		38	
Butan-2-ol	MDHS 72	100 ppm (308 mg/m ³)	150 ppm (462 mg/m ³)	24		50		8		TD, GC	ST 226-357	or ST	226-358	42
Butan-2-ol	MDHS 88	100 ppm (308 mg/m ³)	150 ppm (462 mg/m ³)	diffusive	diffusive	diffusive	diffusive			GC-FID	PS 575-002		75	
Butan-2-ol	MDHS 96	100 ppm (308 mg/m ³)	150 ppm (462 mg/m ³)	10	3	20-50	200	8(3.3)	15	GC-FID	ST 226-01		38	
Butan-2-one (MEK)	MDHS 88	200 ppm (600 mg/m ³)	300 ppm (899 mg/m ³)	diffusive	diffusive	diffusive	diffusive			GC-FID	PS 575-002		75	
Butan-2-one (MEK)	MDHS 96	200 ppm (600 mg/m ³)	300 ppm (899 mg/m ³)	10	3	20-50	200	8(3.3)	15	GC-FID	ST 226-81A		39	
Butane	OSHA CSI	600 ppm (1450 mg/m ³)	750 ppm (1810 mg/m ³)	10		20		8		TD, GC	ST 226-01		38	
2-Butoxyethanol	MDHS 72	25 ppm	50 ppm	24		50		8		TD, GC	ST 226-358		42	
2-Butoxyethanol	MDHS 80	25 ppm	50 ppm	24		50		8		GC-ECD	ST 226-358		42	
2-Butoxyethanol acetate	MDHS 88	20 ppm (133 mg/m ³)	50 ppm (332 mg/m ³)	diffusive	diffusive	diffusive	diffusive			GC-FID	PS 575-001	or PS	575-002	75
n-Butyl acetate	MDHS 72	150 ppm (724 mg/m ³)	200 ppm (966 mg/m ³)	10	3	20	200	8	15	TD, GC	ST 226-358		38	
n-Butyl acetate	MDHS 80	150 ppm (724 mg/m ³)	200 ppm (966 mg/m ³)	24		50		8		GC-ECD	ST 226-358		42	
n-Butyl acetate	MDHS 88	150 ppm (724 mg/m ³)	200 ppm (966 mg/m ³)	diffusive	diffusive	diffusive	diffusive			GC-FID	PS 575-001		75	
n-Butyl acetate	MDHS 96	150 ppm (724 mg/m ³)	200 ppm (966 mg/m ³)	10	3	20	200	8	15	GC-FID	ST 226-01		38	
sec-Butyl acetate	MDHS 88	200 ppm (966 mg/m ³)	250 ppm (1210 mg/m ³)	diffusive	diffusive	diffusive	diffusive			GC-FID	PS 575-001		75	
sec-Butyl acetate	MDHS 96	200 ppm (966 mg/m ³)	250 ppm (1210 mg/m ³)	10	0.75	20	50	8	15	GC-FID	ST 226-01		38	
t-Butyl acetate	MDHS 72	200 ppm (966 mg/m ³)	250 ppm (1210 mg/m ³)	10	3	20	200	8	15	TD, GC	ST 226-358		38	
t-Butyl acetate	MDHS 88	200 ppm (966 mg/m ³)	250 ppm (1210 mg/m ³)	diffusive	diffusive	diffusive	diffusive			GC-FID	PS 575-001		75	
n-Butyl acrylate	MDHS 88	1 ppm (5 mg/m ³)	5 ppm (26 mg/m ³)	diffusive	diffusive	diffusive	diffusive			GC-FID	PS 575-002		75	
Butyl carbitol	OSHA PV2095	10 ppm (67.5 mg/m ³)	15 ppm (101.2 mg/m ³)	10		200		50 min		GC-FID	ST 226-01		38	
n-Butyl chloroformate	ASTM D6209	1 ppm (5.7 mg/m ³)		varies		225		varies		GC-MS	ST 226-131		45	
Butyl lactate	OSHA PV2080	5 ppm (30 mg/m ³)		10		200		8		GC-FID	ST 226-01		38	
2-sec-Butylphenol	OSHA PV2128	5 ppm (31 mg/m ³)		20		200		100 min		HPLC-UV	ST 226-95		40	
Cadmium & compounds (except oxide fume & sulphide pigments)	MDHS 91/2	0.025 mg/m ³		960	30	2000	2000	8	15	XRF	IOM 225-70A	108 FLT	225-1930	88
Cadmium oxide fume (as Cd)	MDHS 91/2	0.025 mg/m ³	0.05 mg/m ³	960		2000		8		XRF	IOM 225-70A	108 FLT	225-1930	88
Cadmium sulphide & pigments (as Cd)	MDHS 91/2	0.03 mg/m ³		960		2000		8		XRF	IOM 225-70A	108 FLT	225-1930	88
Caesium hydroxide	MDHS 91/2	2 mg/m ³		960		2000		8		XRF	IOM 225-70A	108 FLT	225-1930	88

See page 212 for abbreviations.

Sampling Guide — U.K. (HSE)

www.skinc.com for updates

Chemical Hazard	Agency Reference	S A M P L I N G								Analytical Method	SKC Collecting Equipment and Page No.				
		WEL		Vol. (liter)		Rate (ml/min)		Time							
		TWA (ppm)	STEL (ppm)	TWA	STEL	TWA	STEL	TWA (hr)	STEL (min)						
Calcium carbonate (inhalable)	MDHS 14/4	10 mg/m ³		960		2000		8		GR	IOM 225-70A	108 FLT	225-58F	96	
Calcium carbonate (respirable)	MDHS 14/4	4 mg/m ³		1056		2000 (2200)		8		GR	IOM 225-70A	108 FOAM	225-772 or 225-58F	96	
Calcium cyanamide	OSHA ID-121	0.05 mg/m ³	1 mg/m ³	960		2000		8		AA or AES	F/CST C/HLD 225-3-01	or F/CST 102	225-3100	88	
Calcium hydroxide	NIOSH 7020	5 mg/m ³		240		1000		4		AA-F	F/CST C/HLD 225-3-01	or F/CST 102	225-3100	88	
Calcium oxide	NIOSH 7020	2 mg/m ³		240		1000		4		AA-F	F/CST C/HLD 225-3-01	or F/CST 102	225-3100	88	
Calcium silicate (inhalable)	MDHS 14/4	10 mg/m ³		960		2000		8		GR	IOM 225-70A	108 FLT	225-58F	96	
Calcium silicate (respirable)	MDHS 14/4	4 mg/m ³		1056		2000 (2200)		8		GR	IOM 225-70A	108 FOAM	225-772 or 225-58F	96	
Captan (ISO)	MDHS 94/2	5 mg/m ³	15 mg/m ³	240		2000 (500)		8		HPLC-UV	IOM 225-70A	108 FLT	225-58F	96	
Carbon black	MDHS 14/4	3.5 mg/m ³	7 mg/m ³	960		2000		8		GR	IOM 225-70A	108 FLT	225-58F	96	
Carbon dioxide	OSHA ID-172	5000 ppm (9150 mg/m ³)	30000 ppm (54000 mg/m ³)	2-5	2-5	10-50	300	4-8	15	GC	SB 263-Series	or SB	253-Series	56	
Carbon dioxide (by portable GC)	NIOSH 6603	5000 ppm (9150 mg/m ³)	30000 ppm (54000 mg/m ³)							GC	SB 232-Series		55		
Carbon disulphide	MDHS 96	5 ppm (15 mg/m ³)		10	3	20 (50)	200	8 (3.3)	15	GC	ST 226-01	or ST	226-44	39	
Carbon monoxide	OSHA ID-210	30 ppm (35 mg/m ³)	200 ppm (232 mg/m ³)	2-5	2-5	10-50	1000	varies	varies	GC	SB 252-Series	or SB	253-Series	52	
Carbon tetrachloride	MDHS 72	2 ppm (13 mg/m ³)			12		200		60	TD, GC	ST 226-358		38		
Carbon tetrachloride	MDHS 80	2 ppm (13 mg/m ³)		24		50		8		TD, GC	ST 226-358		38		
Carbon tetrachloride	MDHS 88	2 ppm (13 mg/m ³)		diffusive	diffusive	diffusive	diffusive	5	15	GC-FID	ST 575-001		75		
Carbon tetrachloride	MDHS 96	2 ppm (13 mg/m ³)		10		20-50		8		GC-FID	ST 226-01		38		
Cellulose (inhalable dust)	MDHS 14/4	10 mg/m ³	20 mg/m ³	960		2000		8		GR	IOM 225-70A	108 FLT	225-58F	96	
Cellulose (respirable dust)	MDHS 14/4	4 mg/m ³		1056		2000 (2200)		8		GR	IOM 225-70A	108 FOAM	225-772 or 225-58F	96	
Chlorine	NIOSH 6011		0.5 ppm (1.5 mg/m ³)	90	15	1000	1000	1.5	15	IC	CY/CST 225-9006		65		
Chlorine dioxide	OSHA ID-202	0.1 ppm (0.28 mg/m ³)	0.3 ppm (0.84 mg/m ³)	120	7.5	500	500	4	15	IC-ECN	IMP 225-36-2	or IMP	225-36-5	67	
1-Chloro-2,3-epoxypropane (epichlorohydrin)	MDHS 72, 80	0.5 ppm (1.9 mg/m ³)	1.5 ppm (5.8 mg/m ³)	24		50		8		TD, GC	ST 226-358		42		
1-Chloro-2,3-epoxypropane (epichlorohydrin)	MDHS 88	0.5 ppm (1.9 mg/m ³)	1.5 ppm (5.8 mg/m ³)	diffusive	diffusive	diffusive	diffusive			GC-FID	PS 575-002		75		
1-Chloro-2,3-epoxypropane (epichlorohydrin)	MDHS 96	0.5 ppm (1.9 mg/m ³)	1.5 ppm (5.8 mg/m ³)	10		20-50		8		GC-FID	ST 226-01		38		
1-Chloro-4-nitrobenzene	NIOSH 2005	1 mg/m ³	2 mg/m ³	96		200		8		GC-FID	ST 226-10		38		
Chloroacetaldehyde	NIOSH 2015		1 ppm (3.3 mg/m ³)		3		200		15	GC-ECD	ST 226-15GWS		38		
2-Chloroacetophenone	OSHA CSI	0.05 ppm (0.32 mg/m ³)		12		200		1		HPLC-UV	ST 226-47-01		38		
Chlorobenzene	MDHS 72	1 ppm (4.7 mg/m ³)	3 ppm (14 mg/m ³)	10		20(50)		8(3.3)		TD, GC	ST 226-358		38		
Chlorobenzene	MDHS 88	1 ppm (4.7 mg/m ³)	3 ppm (14 mg/m ³)	diffusive	diffusive	diffusive	diffusive			GC-FID	PS 575-001		75		
Chlorobenzene	MDHS 96	1 ppm (4.7 mg/m ³)	3 ppm (14 mg/m ³)	10		20(50)		8(3.3)		GC-FID	ST 226-01		38		
Chlorodifluoromethane	MDHS 96	1000 ppm (3590 mg/m ³)		varies		varies		varies		GC-FID	ST 226-01		38		
Chloroethane	MDHS 96	50 ppm (134 mg/m ³)		3		50		1		GC-FID	ST 226-09		38		
2-Chloroethanol	MDHS 96		1 ppm (3.4 mg/m ³)	10	3	20(50)	200	8(3.3)	15	GC-FID	ST 226-81A		39		
Chloroform	MDHS 80	2 ppm (9.9 mg/m ³)		24		50		8		GC-ECD	ST 226-357		42		
Chloroform	MDHS 88	2 ppm (9.9 mg/m ³)		diffusive	diffusive	diffusive	diffusive			GC-FID	PS 575-001		75		
Chloroform	MDHS 96	2 ppm (9.9 mg/m ³)		10		200		8		GC-FID	ST 226-01		38		
Chloromethane	MDHS 96	50 ppm (105 mg/m ³)	100 ppm (210 mg/m ³)		0.5		100		5	GC-FID	ST 226-09	or ST	226-01	38	
bis-Chloromethyl ether	OSHA 10	0.001 ppm (0.005 mg/m ³)		50		500		100 min		GC-ECD	IMP 225-36-2	67 IT	225-22	67	
Chloropyrifos (ISO)	MDHS 94/2	0.2 mg/m ³	0.6 mg/m ³	240		500		8		HPLC-UV	IOM 225-70A	108 FLT	225-58F	96	
Chromium & inorganic compounds	MDHS 91/2	0.5 mg/m ³		960		2000		8		XRF	IOM 225-70A	108 FLT	225-1930	88	
Chromium (VI) in chromium plating mist	MDHS 52/4	0.05 mg/m ³		960	120	2000	2000	8	60	CLR	Chromic acid test kit	510-2000 and IOM	225-70A	108 FLT	225-9026
Chromium II & III compounds (as Cr)	MDHS 91/2	0.5 mg/m ³		960		2000		8		XRF	IOM 225-70A	108 FLT	225-1930	88	
Chromium VI compounds (as Cr)	MDHS 52/4	0.05 mg/m ³		240	30	2000	2000	2	15	CLR	IOM 225-70A	108 FLT	225-9026		
Cobalt & cobalt compounds (as Co)	MDHS 91/2	0.1 mg/m ³		240		2000		2		XRF	IOM 225-70A	108 FLT	225-1930	88	
Colophony	MDHS 83/3			960	30	2000	2000	8	15	GC-FID	CST 225-8050K (kit)				
Copper dust & mists (as Cu)	MDHS 91/2	1 mg/m ³	2 mg/m ³	960		2000		8		XRF	IOM 225-70A	108 FLT	225-1930	88	
Copper fume	MDHS 91/2	0.2 mg/m ³		960		2000		8		XRF	IOM 225-70A	108 FLT	225-1930	88	
Cotton dust	MDHS 14/4	2.5 mg/m ³		960		2000		8		GR	IOM 225-70A	108 FLT	225-58F	96	
Cryofluorane (INN)	MDHS 96	1000 ppm (7110 mg/m ³)	1250 ppm (8890 mg/m ³)	3		20		2.5		GC-FID	ST 226-01	or ST	226-09	38	
Cumene	MDHS 72, 80	25 ppm (125 mg/m ³)	50 ppm (250 mg/m ³)	24		50		8		TD, GC	ST 226-358		42		
Cumene	MDHS 88	25 ppm (125 mg/m ³)	50 ppm (250 mg/m ³)	diffusive	diffusive	diffusive	diffusive			GC-FID	PS 575-001		75		
Cumene	MDHS 96	25 ppm (125 mg/m ³)	50 ppm (250 mg/m ³)	10		20	50	8	15	GC-FID	ST 226-01		38		
Cyanamide	OSHA CSI	0.58 ppm (1 mg/m ³)		10		100		100 min		HPLC-UV	ST 226-30-18		38		

See page 212 for abbreviations.

Chemical Hazard	Agency Reference	S A M P L I N G								Analytical Method	SKC Collecting Equipment and Page No.				
		WEL		Vol. (liter)		Rate (ml/min)		Time							
		TWA (ppm)	STEL (ppm)	TWA	STEL	TWA	STEL	TWA (hr)	STEL (min)						
Cyanides (except HCN, cyanogen & cyanogen chloride)	NIOSH 7904	5 mg/m ³		120		500		4		ISE	FLT 225-2705 IMP 225-36-2 C/HLD 225-1	94 CST 67 IT 225-1	225-2LF 225-22	97 67	
Cyanogen chloride	OSHA CSI		0.3 ppm (0.77 mg/m ³)		1		200		5	GC-NPD	ST 226-117	40			
Cyclohexane	MDHS 88	100 ppm (350 mg/m ³)	300 ppm (1050 mg/m ³)	diffusive	diffusive	diffusive	diffusive			GC-FID	PS 575-001	75			
Cyclohexane	MDHS 96	100 ppm (350 mg/m ³)	300 ppm (1050 mg/m ³)	10		20		8		GC-FID	ST 226-01	38			
Cyclohexanol	MDHS 88	50 ppm (208 mg/m ³)		diffusive	diffusive	diffusive	diffusive			GC-FID	PS 575-001	75			
Cyclohexanol	MDHS 96	50 ppm (208 mg/m ³)		10		20-50		8(3.3)		GC-FID	ST 226-01	38			
Cyclohexanone	MDHS 88	10 ppm (41 mg/m ³)	20 ppm (82 mg/m ³)	diffusive	diffusive	diffusive	diffusive			GC-FID	PS 575-002	75			
Cyclohexanone	MDHS 96	10 ppm (41 mg/m ³)	20 ppm (82 mg/m ³)	10		20	50	8	15	GC-FID	ST 226-01	38			
Cyclohexylamine	OSHA PV2016	10 ppm (41 mg/m ³)		20		200		100 min		GC-FID	ST 226-98	40			
2,4-D (ISO)	NIOSH 5602	10 mg/m ³	20 mg/m ³	480		1000		8		GC-ECD	ST 226-58	39			
Dialkyl phthalate C7-C9	OSHA 104	5 mg/m ³		240		1000		4		GC-FID	ST 226-56	39			
Diallyl phthalate	OSHA CSI	5 mg/m ³		60		1000		1		GC-FID	ST 226-30-16	38			
Diatomaceous earth (natural respirable dust)	MDHS 14/4	1.2 mg/m ³		960 (1056)		2000 (2200)		8		GR	IOM 225-70A CYC 225-69	108 FOAM 111 FLT	225-772 225-58F	or 96	
Dibenzoyl peroxide	NIOSH 5009	5 mg/m ³		90		1500		1		HPLC-UV	F/CST 225-3-01	88			
Dibismuth trielluride	MDHS 91/2	10 mg/m ³	20 mg/m ³	960		2000		8		XRF	IOM 225-70A	108 FLT	225-1930	88	
Diboron trioxide	MDHS 14/4	10 mg/m ³	20 mg/m ³	960 (1056)		2000 (2200)		8		GR	IOM 225-70A CYC 225-69	108 FOAM 111 FLT	225-772 225-58F	or 96	
1,2-Dibromoethane	MDHS 88	0.5 ppm (3.9 mg/m ³)		diffusive	diffusive	diffusive	diffusive			GC-FID	PS 575-001	75			
1,2-Dibromoethane	MDHS 96	0.5 ppm (3.9 mg/m ³)		10	3	20	200	8	15	GC-ECD	ST 226-01	38			
Dibutyl hydrogen phosphate	NIOSH 5017	1 ppm (8.7 mg/m ³)	2 ppm (17 mg/m ³)	240		2000		2		GC-FPD	FLT 225-17-01 C/HLD 225-1	94 CST 102	225-2LF	97	
Dibutyl phthalate	OSHA 104	5 mg/m ³		240		1000		4		GC-FID	ST 226-56	38			
2,2'-Dichloro-4,4'-methylene dianiline (MbOCA)	MDHS 75/2	0.005 mg/m ³		100		1000		100 min		GC-ECD	CF/CST 225-9004	64 C/HLD	225-1	102	
2,2-Dichloro-4,4'-methylene dianiline (MbOCA)	MDHS 75/2	0.005 mg/m ³			200		2000		each 100 min	HPLC	IOM 225-70A	108 FLT	225-58F	96	
1,3-Dichloro-5,5-dimethylhydantoin			0.2 mg/m ³	0.4 mg/m ³											
Dichloroacetylene	OSHA CSI		0.1 ppm (0.39 mg/m ³)		1		200		5	GC-FID	ST 226-01	38			
1,2-Dichlorobenzene (ortho-dichlorobenzene)	MDHS 88	25 ppm (153 mg/m ³)	50 ppm (306 mg/m ³)	diffusive	diffusive	diffusive	diffusive			GC-FID	PS 575-001	75			
1,2-Dichlorobenzene (ortho-dichlorobenzene)	MDHS 96	25 ppm (153 mg/m ³)	50 ppm (306 mg/m ³)	10	3	20	200	8	15	GC-FID	ST 226-01	38			
1,4-Dichlorobenzene (para-dichlorobenzene)	MDHS 88	25 ppm (153 mg/m ³)	50 ppm (306 mg/m ³)	diffusive	diffusive	diffusive	diffusive			GC-FID	PS 575-001	75			
1,4-Dichlorobenzene (para-dichlorobenzene)	MDHS 96	25 ppm (153 mg/m ³)	50 ppm (306 mg/m ³)	3		20		2.5		GC-FID	ST 226-01	38			
1,1-Dichloroethane	MDHS 96	100 ppm		10	3	200	200	8	15	GC-FID	ST 226-01	38			
1,2-Dichloroethane (ethylene dichloride)	MDHS 72, 80	5 ppm (21 mg/m ³)		24		50		8		TD, GC	ST 226-358	42			
1,2-Dichloroethane (ethylene dichloride)	MDHS 88	5 ppm (21 mg/m ³)		diffusive	diffusive	diffusive	diffusive			GC-FID	PS 575-001	75			
1,2-Dichloroethane (ethylene dichloride)	MDHS 96	5 ppm (21 mg/m ³)		10	3	20	200	8	15	GC-FID	ST 226-01	38			
1,2-Dichloroethylene cis:trans isomers 60:40	MDHS 88	200 ppm (806 mg/m ³)	250 ppm (1010 mg/m ³)	diffusive	diffusive	diffusive	diffusive			GC-FID	PS 575-001	75			
1,2-Dichloroethylene cis:trans isomers 60:40	MDHS 96	200 ppm (806 mg/m ³)	250 ppm (1010 mg/m ³)	5		50		100 min		GC-FID	ST 226-01	38			
Dichlorofluoromethane	MDHS 96	10 ppm (43 mg/m ³)		3		20		2.5		GC-FID	ST 226-01	38			
Dichloromethane	MDHS 72, 80	100 ppm (350 mg/m ³)	300 ppm (1060 mg/m ³)	24		50		8		TD, GC	ST 226-358	42			
Dichloromethane	MDHS 88	100 ppm (350 mg/m ³)	300 ppm (1060 mg/m ³)	diffusive	diffusive	diffusive	diffusive			GC-FID	PS 575-001	75			
Dichloromethane	MDHS 96	100 ppm (350 mg/m ³)	300 ppm (1060 mg/m ³)	2	1.5	20	100	1.6	15	GC-FID	ST 226-01	38			
Dicyclopentadiene	MDHS 88	5 ppm (27 mg/m ³)		diffusive	diffusive	diffusive	diffusive			GC-FID	PS 575-001	75			
Diethyl ether	MDHS 88	100 ppm (310 mg/m ³)	200 ppm (620 mg/m ³)	diffusive	diffusive	diffusive	diffusive			GC-FID	PS 575-001	75			
Diethyl ether	MDHS 96	100 ppm (310 mg/m ³)	200 ppm (620 mg/m ³)	3		20		2.5		GC-FID	ST 226-01	38			
Diethyl phthalate	OSHA 104			240		1000		4		GC-FID	ST 226-56	38			
Diethyl sulphate	MDHS 89	0.05 ppm (0.32 mg/m ³)								GC-MS	ST 226-357	42			
Diethylamine	MDHS 96	5 ppm (15 mg/m ³)	10 ppm (30 mg/m ³)	24	3	50	200	8	15	GC-FID	ST 226-10	38			
Dihydrogen selenide (as Se)	OSHA CSI	0.02 ppm (0.07 mg/m ³)	0.05 ppm (0.17 mg/m ³)	480		1000		8		AA	IMP 225-36-2 IT 225-22	or IMP 67	225-36-5	67	
Diisopropyl ether	MDHS 88	250 ppm (1060 mg/m ³)	310 ppm (1310 mg/m ³)	diffusive	diffusive	diffusive	diffusive			GC-FID	PS 575-001	75			
Diisopropyl ether	MDHS 96	250 ppm (1060 mg/m ³)	310 ppm (1310 mg/m ³)	3		20		2.5		GC-FID	ST 226-01	38			
Diisopropylamine	OSHA CSI	5 ppm (21 mg/m ³)		120		1000		1		GC-ECD	IMP 225-36-2 IT 225-22	or IMP 67	225-36-1	67	
Dimethoxymethane	MDHS 88	1000 ppm (3160 mg/m ³)	1250 ppm (3950 mg/m ³)	diffusive	diffusive	diffusive	diffusive			GC-FID	PS 575-001	75			
Dimethoxymethane	MDHS 96	1000 ppm (3160 mg/m ³)	1250 ppm (3950 mg/m ³)	2		20		1.5		GC-FID	ST 226-01	38			
Dimethyl ether		400 ppm (766 mg/m ³)	500 ppm (958 mg/m ³)							CLR	DT 810-161				
Dimethyl phthalate	OSHA 104	5 mg/m ³		240		1000		4		GC-FID	ST 226-56	38			
Dimethyl phthalate	OSHA 104	5 mg/m ³	10 mg/m ³	240		1000		4		GC-FID	ST 226-56	39			

See page 212 for abbreviations.

Sampling Guide — U.K. (HSE)

www.skinc.com for updates

Chemical Hazard	Agency Reference	S A M P L I N G								Analytical Method	SKC Collecting Equipment and Page No.		
		WEL		Vol. (liter)		Rate (ml/min)		Time					
		TWA (ppm)	STEL (ppm)	TWA	STEL	TWA	STEL	TWA (hr)	STEL (min)				
Dimethyl sulphate	MDHS 89	0.05 ppm (0.32 mg/m ³)								GC-MS	ST	226-357	42
Dimethyl sulphate	MDHS 96	0.05 ppm (0.26 mg/m ³)		12		50		4		GC-ECN	ST	226-114	40
N,N-Dimethylacetamide	MDHS 96	10 ppm (36 mg/m ³)	20 ppm (72 mg/m ³)	48		100		8		GC-FID	ST	226-10	38
Dimethylamine	MDHS 96	2 ppm (3.8 mg/m ³)	6 ppm (11 mg/m ³)							GC-FID	ST	226-10	38
2-Dimethylaminoethanol	OSHA CSI	2 ppm (7.4 mg/m ³)	6 ppm (22 mg/m ³)	24		200		8		GC-FID	ST	226-10-04	38
N,N-Dimethylaniline	MDHS 88	5 ppm (25 mg/m ³)	10 ppm (50 mg/m ³)	diffusive	diffusive	diffusive	diffusive			GC-FID	PS	575-001	75
N,N-Dimethylaniline	MDHS 96	5 ppm (25 mg/m ³)	10 ppm (50 mg/m ³)	24	3	50	200	8	15	GC-FID	ST	226-10	38
N,N-Dimethylethylamine	OSHA PV2096	10 ppm (30 mg/m ³)	15 ppm (46 mg/m ³)	40		100		40 min		GC-NPD	ST	226-18	38
Dimethylformamide	MDHS 88	5 ppm (15 mg/m ³)	10 ppm (30 mg/m ³)	diffusive	diffusive	diffusive	diffusive			GC-FID	PS	575-002	75
2,6-Dimethylheptan-4-one	MDHS 88	25 ppm (148 mg/m ³)		diffusive	diffusive	diffusive	diffusive			GC-FID	PS	575-002	75
2,6-Dimethylheptan-4-one	MDHS 96	25 ppm (148 mg/m ³)		10		20(50)		8(3.3)		GC-FID	ST	226-01	38
Dinitrobenzene (all isomers)	OSHA CSI	0.15 ppm (1 mg/m ³)	0.5 ppm (3.5 mg/m ³)	60		1000		1		HPLC-UV	ST	226-30-16	38
1,4-Dioxane	MDHS 88	20 ppm (73 mg/m ³)		diffusive	diffusive	diffusive	diffusive			GC-FID	PS	575-002	75
1,4-Dioxane	MDHS 96	20 ppm (73 mg/m ³)		10		20		8		GC-FID	ST	226-01	38
Diphenyl ether (vapour)	MDHS 88	1 ppm (7.1 mg/m ³)		diffusive	diffusive	diffusive	diffusive			GC-FID	PS	575-001	75
Diphenyl ether (vapour)	MDHS 96	1 ppm (7.1 mg/m ³)		30		100		5		GC-FID	ST	226-35-01	38
Diphenylamine	OSHA 78	10 mg/m ³	20 mg/m ³	100		1000		100 min		HPLC-UV	CF/CST	225-9004	64 C/HLD 225-1 102
Diphosphorus pentasulphide	OSHA ID-128SG	1 mg/m ³	2 mg/m ³	960	30	2000	2000	8	15	IC	F/CST	225-802	93 C/HLD 225-1 102
Diphosphorus pentoxide	OSHA ID-111	1 mg/m ³	2 mg/m ³	480		1000		8		IC	F/CST	225-3-01	88 C/HLD 225-1 102
Dipropylene glycol methyl ether	MDHS 72	50 ppm (308 mg/m ³)		24		50		8		TD, GC	ST	226-357	or ST 226-358 42
Dipropylene glycol methyl ether	MDHS 88	50 ppm (308 mg/m ³)		diffusive	diffusive	diffusive	diffusive			GC-FID	PS	575-002	75
Diquat dibromide (ISO)	OSHA CSI	0.5 mg/m ³	1 mg/m ³	120		1000		8		HPLC/UV	IOM	225-70A	108 FLT 225-58F 96
Disodium disulphite	OSHA ID-121	5 mg/m ³		960		2000		8		AA or AES	F/CST	225-3-01	88 C/HLD 225-1 102
Disodium tetraborate (anhydrous)	OSHA ID-125G	1 mg/m ³		480		2000		4		ICP-AES	F/CST	225-3-01	or F/CST 225-3100 88 C/HLD 225-1 102
Disodium tetraborate (decahydrate)	OSHA ID-125G	5 mg/m ³		480		2000		4		ICP-AES	F/CST	225-3-01	or F/CST 225-3100 88 C/HLD 225-1 102
Disodium tetraborate (pentahydrate)	OSHA ID-125G	1 mg/m ³		480		2000		4		ICP-AES	F/CST	225-3-01	or F/CST 225-3100 88 C/HLD 225-1 102
Disulphur dichloride	OSHA CSI		1 ppm (5.6 mg/m ³)	480		1000		8		CLR	IMP	225-36-2	67 IT 225-22 67
6,6'-Di-tert-butyl-4,4'-thiodi-m-cresol	OSHA CSI	10 mg/m ³	20 mg/m ³	varies		varies		varies		HPLC-UV	F/CST	225-706	or CYC 225-69-35 111 FLT 225-7 96
2,6-Di-tert-butyl-p-cresol	OSHA PV2108	10 mg/m ³		100		1000		100 min		GC-FID	ST	226-57	39
Diuron (ISO)	NIOSH 5601	10 mg/m ³		240		1000		4		HPLC-UV	ST	226-58	or ST 226-30-16 38
Dusts (Inhalable)	MDHS 14/4			960		2000		8		GR	IOM	225-70A	108 FLT 225-58F 96
Dusts (Respirable)	MDHS 14/4			1056		2000 (2200)		8		GR	IOM	225-70A	108 FLT 225-58F 96
											FOAM	225-772	or CYC 225-69 111 FLT 225-58F 96
Emery (inhalable dust)	MDHS 14/4	10 mg/m ³		960		2000		8		GR	IOM	225-70A	108 FLT 225-58F 96
Emery (respirable dust)	MDHS 14/4	4 mg/m ³		1056		2200		8		GR	CYC	225-69	111 FLT 225-58F or IOM 225-70A 108 FOAM 225-772 108 FLT 225-58F 96
Endosulfan (ISO)	MDHS 94/2	0.1 mg/m ³	0.3 mg/m ³	240		500		8		HPLC-UV	IOM	225-70A	108 FLT 225-58F 96
											ST	226-35	38
Enflurane	MDHS 80	50 ppm (383 mg/m ³)		24		50		8		GC-ECD	ST	226-357	42
Enflurane	MDHS 88	50 ppm (383 mg/m ³)		diffusive	diffusive	diffusive	diffusive			GC-FID	PS	575-002	75
Ethane-1,2-diol (particulate)	MDHS 14/4	10 mg/m ³		960		2000		8		GR	IOM	225-70A	108 FLT 225-58F 96
Ethane-1,2-diol (vapour)	MDHS 88	20 ppm (52 mg/m ³)	40 ppm (104 mg/m ³)	diffusive	diffusive	diffusive	diffusive			GC-FID	PS	575-002	75
Ethanthiol	NIOSH 2542	0.5 ppm (1.3 mg/m ³)	2 ppm (5.2 mg/m ³)	48	12	100	200	8	60	GC-FPD	F/CST	225-9007	65
Ethanol	MDHS 72	1000 ppm (1920 mg/m ³)		24		50		8		TD, GC	ST	226-358	42
Ethanol	MDHS 88	1000 ppm (1920 mg/m ³)		diffusive	diffusive	diffusive	diffusive	8	15	GC-FID	PS	575-002	75
Ethanol	MDHS 96	1000 ppm (1920 mg/m ³)		1		50		20 min		GC-FID	ST	226-01	38
2-(Methoxyethoxy)ethanol	OSHA CSI	10 ppm (50.1 mg/m ³)		6		100		1		GC-FID	ST	226-01	38
2-Ethoxyethanol	MDHS 72	2 ppm (8 mg/m ³)		24		50		8		TD, GC	ST	226-357	42
2-Ethoxyethanol	MDHS 80	2 ppm (8 mg/m ³)		24		50		8		GC-ECD	ST	226-357	42
2-Ethoxyethanol	MDHS 88	2 ppm (8 mg/m ³)		diffusive	diffusive	diffusive	diffusive			GC-FID	PS	575-001	75
2-Ethoxyethanol	MDHS 96	2 ppm (8 mg/m ³)		5		20		4		GC-FID	ST	226-01	38
2-Ethoxyethyl acetate	MDHS 72	2 ppm (11 mg/m ³)		24		50		8		TD, GC	ST	226-357	42
2-Ethoxyethyl acetate	MDHS 80	2 ppm (11 mg/m ³)		24		50		8		GC-ECD	ST	226-357	or ST 226-358 42
2-Ethoxyethyl acetate	MDHS 88	2 ppm (11 mg/m ³)		diffusive	diffusive	diffusive	diffusive			GC-FID	PS	575-001	75
Ethyl acetate	MDHS 72, 80	200 ppm	400 ppm	24		50		8		TD, GC	ST	226-357	or ST 226-358 42
Ethyl acetate	MDHS 88	200 ppm	400 ppm	diffusive	diffusive	diffusive	diffusive			GC-FID	PS	575-001	75
Ethyl acetate	MDHS 96	200 ppm	400 ppm	10		20		8		GC-FID	ST	226-01	38
Ethyl acrylate	MDHS 72	5 ppm (21 mg/m ³)	10 ppm (42 mg/m ³)	24		50		8		TD, GC	ST	226-357	42
Ethyl acrylate	MDHS 88	5 ppm (21 mg/m ³)	10 ppm (42 mg/m ³)	diffusive	diffusive	diffusive	diffusive			GC-FID	PS	575-002	75
Ethyl acrylate	MDHS 96	5 ppm (21 mg/m ³)	10 ppm (42 mg/m ³)	10		20		8		GC-FID	ST	226-01	38
Ethyl benzene	MDHS 72	100 ppm (441 mg/m ³)	125 ppm (552 mg/m ³)	24		50		8		TD, GC	ST	226-357	42

See page 212 for abbreviations.

Chemical Hazard	Agency Reference	SAMPLING								Analytical Method	SKC Collecting Equipment and Page No.			
		WEL		Vol. (liter)		Rate (ml/min)		Time						
		TWA (ppm)	STEL (ppm)	TWA	STEL	TWA	STEL	TWA (hr)	STEL (min)					
Ethyl benzene	MDHS 80	100 ppm (441 mg/m ³)	125 ppm (552 mg/m ³)	24		50		8		GC-ECD	ST 226-357	42		
Ethyl benzene	MDHS 88	100 ppm (441 mg/m ³)	125 ppm (552 mg/m ³)	diffusive	diffusive	diffusive	diffusive			GC-FID	PS 575-001	75		
Ethyl benzene	MDHS 96	100 ppm (441 mg/m ³)	125 ppm (552 mg/m ³)	12		50		4		GC-FID	ST 226-01	38		
Ethyl cyanoacrylate	OSHA 55		0.3 ppm (1.5 mg/m ³)	12		100		2		HPLC-UV	ST 226-98	40		
Ethyl formate	MDHS 96	100 ppm (308 mg/m ³)	150 ppm (462 mg/m ³)	10		20		8		GC-FID	ST 226-01	38		
Ethylamine	OSHA 36	2 ppm (3.8 mg/m ³)	6 ppm (11 mg/m ³)	10		200		50 min		HPLC-UV	ST 226-96	40		
Ethylene oxide	MDHS 88	5 ppm (9.2 mg/m ³)		diffusive	diffusive	diffusive	diffusive			GC-FID	PS 575-005	75		
Ethylene oxide	MDHS 96	5 ppm (9.2 mg/m ³)								GC-FID	ST 226-01	38		
Ethylenediamine	NIOSH 2540	1 ppm (4.3 mg/m ³)		10		100		1.7		HPLC-UV	ST 226-90-18	38		
2-Ethylhexyl chloroformate			1 ppm (8 mg/m ³)											
bis-2-Ethylhexyl phthalate (dioctyl phthalate)	MDHS 96	5 mg/m ³	10 mg/m ³	50		10		8		GC-FID	ST 226-96 ¶	39		
bis-2-Ethylhexyl phthalate (dioctyl phthalate)	OSHA 104	5 mg/m ³		240		1000		4		GC-FID	ST 226-56	38		
4-Ethylmorpholine	OSHA CSI	5 ppm (24 mg/m ³)	20 ppm (96 mg/m ³)	10		20		8		GC-FID	ST 226-10	38		
Ferrous foundary particulate (inhalable)	MDHS 14/4	10 mg/m ³		960		2000		8		GR	IOM 225-70A	108 FLT	225-58F	96
Ferrous foundary particulate (respirable)	MDHS 14/4	4 mg/m ³		1056		2200 (2000)		8		GR	CYC 225-69 IOM 225-70A FLT 225-58F	111 FLT 108 FOAM 96	225-58F 225-772	or 108
Flour dust	MDHS 14/4	10 mg/m ³	30 mg/m ³			2000	2000	8	15	GR	IOM 225-70A	108 FLT	225-58F	96
Fluoride (inorganic as F)	Contact SKC	2.5 mg/m ³		960	30	2000	2000	8	15	IC	IOM 225-70A	108 FLT	225-1930	88
Fluorine	OSHA CSI	1 ppm (1.6 mg/m ³)	1 ppm (1.6 mg/m ³)	480		1000		8		CLR	IMP 225-96-2 IT 225-22	or IMP	225-36-5	67
Formaldehyde	MDHS 102	2 ppm (2.5 mg/m ³)	2 ppm (2.5 mg/m ³)	varies		varies		varies		HPLC	CF/CST 225-9003 ST 226-120	or ST	226-119	or
Formamide	OSHA CSI	20 ppm (37 mg/m ³)	30 ppm (56 mg/m ³)	10	1.5	100	100	100 min	100 min	GC-NPD	ST 226-10	38		
Formic acid	NIOSH 2011	5 ppm (9.6 mg/m ³)		24		200		2		IC-ECN	FLT 225-2708 ST 226-10-03	94 CST 38 C/HLD	225-3-25LF 225-1	97 102
2-Furaldehyde (furfural)	MDHS 72	2 ppm (8 mg/m ³)	5 ppm (20 mg/m ³)	24		50		8		TD, GC	ST 226-357	42		
2-Furaldehyde (furfural)	NIOSH 2529	5 ppm (20 mg/m ³)		5		20		4		GC-FID	ST 226-118	40		
2-Furaldehyde (furfural)	OSHA 72	5 ppm (20 mg/m ³)		180		1000		3		TD, GC	ST 226-81A	40		
Glutaraldehyde	MDHS 102	0.05 ppm (0.2 mg/m ³)	0.05 ppm (0.2 mg/m ³)	varies		varies		varies		HPLC	CF/CST 225-9003 ST 226-120	or ST	226-119	or
Glutaraldehyde	MDHS 102	0.05 ppm (0.2 mg/m ³)	0.05 ppm (0.2 mg/m ³)	diffusive	diffusive	diffusive	diffusive			HPLC	PS 500-100	84		
Glycerol mist	NIOSH 600	10 mg/m ³		375		2500		2.5		GR	CYC 225-01-02 CST 225-3LF	111 FLT 97 C/HLD	225-5-37-P 225-1	93 102
Grain dust	MDHS 14/4	10 mg/m ³		960		2000		8		GR	IOM 225-70A	108 FLT	225-58F	96
Graphite (inhalable dust)	MDHS 14/4	10 mg/m ³		960		2000		8		GR	IOM 225-70A	108 FLT	225-58F	96
Graphite (respirable dust)	MDHS 14/4	4 mg/m ³		1056		2200		8		GR	CYC 225-69 IOM 225-70A FLT 225-58F	111 FLT 108 FOAM 96	225-58F 225-772	or 108
Gypsum (inhalable dust)	MDHS 14/4	10 mg/m ³		960		2000		8		GR	IOM 225-70A	108 FLT	225-58F	96
Gypsum (respirable dust)	MDHS 14/4	4 mg/m ³		1056		2200		8		GR	CYC 225-69 IOM 225-70A FLT 225-58F	111 FLT 108 FOAM 96	225-58F 225-772	or 108
Halogeno platinum compounds as Pt	MDHS 91/2	0.002 mg/m ³		30		50		8		AAS	IOM 225-70A	108 FLT	225-1930	88
Halothane	MDHS 80	10 ppm (82 mg/m ³)		24		50		8		GC-ECD	ST 226-357	or ST	226-358	42
Halothane	MDHS 88	10 ppm (82 mg/m ³)		diffusive	diffusive	diffusive	diffusive			GC-FID	PS 575-002	75		
Hardwood dust	MDHS 14/4	5 mg/m ³								GR	IOM 225-70A	108 FLT	225-58F	96
Heptan-2-one	MDHS 88	50 ppm (237 mg/m ³)	100 ppm (475 mg/m ³)	diffusive	diffusive	diffusive	diffusive			GC-FID	PS 575-002	75		
Heptan-2-one	MDHS 96	50 ppm (237 mg/m ³)	100 ppm (475 mg/m ³)							GC-FID	ST 226-01	38		
Heptan-3-one	MDHS 88	35 ppm (166 mg/m ³)	100 ppm (475 mg/m ³)	diffusive	diffusive	diffusive	diffusive			GC-FID	PS 575-001	or PS	575-002	75
Heptan-3-one	MDHS 96	35 ppm (166 mg/m ³)	100 ppm (475 mg/m ³)							GC-FID	ST 226-01	38		
n-Heptane	MDHS 72, 80	500 ppm (2085 mg/m ³)								TD, GC	ST 226-357	42		
n-Heptane	MDHS 88	500 ppm (2085 mg/m ³)		diffusive	diffusive	diffusive	diffusive			GC-FID	PS 575-001	75		
n-Heptane	MDHS 96	500 ppm (2085 mg/m ³)								GC-FID	ST 226-01	38		
Hexan-2-one	MDHS 88	5 ppm (21 mg/m ³)		diffusive	diffusive	diffusive	diffusive			GC-FID	PS 575-002	75		
Hexan-2-one	MDHS 96	5 ppm (21 mg/m ³)		10		20		8		GC-FID	ST 226-01	38		
n-Hexane	MDHS 72	20 ppm (72 mg/m ³)		24		50		8		TD, GC	ST 226-357	42		
n-Hexane	MDHS 80	20 ppm (72 mg/m ³)		24		50		8		GC-ECD	ST 226-358	42		
n-Hexane	MDHS 88	20 ppm (72 mg/m ³)		diffusive	diffusive	diffusive	diffusive			GC-FID	PS 575-001	75		
n-Hexane	MDHS 96	20 ppm (72 mg/m ³)		4		20		3.3		GC-FID	ST 226-01	38		
1,6-Hexanolactam (dust & vapour)	OSHA PV2012	10 mg/m ³	20 mg/m ³	100	15	1000	1000	8	15	HPLC-UV	ST 226-57	39		
1,6-Hexanolactam (dust only)	MDHS 14/4	1 mg/m ³	3 mg/m ³	1056		2000 (2200)		8		GR	IOM 225-70A CYC 225-69	108 FOAM 111 FLT	225-772 225-58F	or 96
Hydrazine	MDHS 86/2	0.02 ppm (0.03 mg/m ³)	0.1 ppm (0.13 mg/m ³)	240		1000		4		IC-UV	CF/CST 225-9012	64 C/HLD	225-1	102
Hydrogen bromide	OSHA ID-165SG		3 ppm (10 mg/m ³)	48	4.5	200	300	4	15	IC	ST 226-10-03	38		
Hydrogen chloride (gas & aerosol mists)	OSHA ID-174SG	1 ppm (2 mg/m ³)	5 ppm (8 mg/m ³)	48	4.5	200	300	4	15	IC	ST 226-10-03	38		

See page 212 for abbreviations.

Sampling Guide — U.K. (HSE)

www.skinc.com for updates

Chemical Hazard	Agency Reference	S A M P L I N G								Analytical Method	SKC Collecting Equipment and Page No.			
		WEL		Vol. (liter)		Rate (ml/min)		Time						
		TWA (ppm)	STEL (ppm)	TWA	STEL	TWA	STEL	TWA (hr)	STEL (min)					
Hydrogen cyanide	MDHS 56/3		10 ppm (11 mg/m ³)	40	15	200	1000	3	15	ISE	IMP 225-36-2 IOM 225-70A	67 IT 108 FLT	225-22 225-1930	67 88
Hydrogen fluoride (as F)	Contact SKC	1.8 ppm (1.5 mg/m ³)	3 ppm (2.5 mg/m ³)		30		2000		15	ISE	IOM 225-70A	108 FLT	225-1930	88
Hydrogen peroxide	OSHA ID-126SG	1 ppm (1.4 mg/m ³)	2 ppm (2.8 mg/m ³)	100		1000		100 min		DPP	IMP 225-36-2 IT 225-22	or IMP 225-36-5 67	67	
Hydrogen sulphide	OSHA 1008	5 ppm (7 mg/m ³)	10 ppm (14 mg/m ³)							IC	ST 226-177	41		
Hydroquinone	MDHS 98/3	0.5 mg/m ³			30		2000		15	HPLC-UV	IOM 225-70A ST 226-35-03	108 FLT 39	225-58F	96
4-Hydroxy-4-methylpentan-2-one	MDHS 88	50 ppm (241 mg/m ³)	75 ppm (362 mg/m ³)	diffusive	diffusive	diffusive	diffusive			GC-FID	PS 575-002	75		
4-Hydroxy-4-methylpentan-2-one	MDHS 96	50 ppm (241 mg/m ³)	75 ppm (362 mg/m ³)	10		20		8		GC-FID	ST 226-01	38		
2-Hydroxypropyl acrylate	OSHA PV2078	0.5 ppm (2.7 mg/m ³)		10		100		100 min		GC-FID	ST 226-73	39		
Indene	OSHA CSI	10 ppm (48 mg/m ³)	15 ppm (72 mg/m ³)	10		20		8		GC-FID	ST 226-110	40		
Indium & compounds (as In)	MDHS 91/2	0.1 mg/m ³	0.3 mg/m ³	960		2000		8		XRF	IOM 225-70A	108 FLT	225-1930	88
Iodine	NIOSH 6005	0.1 ppm (1.1 mg/m ³)		15		1000		15		IC	ST 226-67	39		
Iodoform	OSHA CSI	0.6 ppm (9.8 mg/m ³)	1 ppm (16 mg/m ³)	10		100		100 min		GC-ECD	F/CST 225-706 ST 226-93	96 C/HLD 40	225-1	102
Iodomethane	MDHS 88	2 ppm (12 mg/m ³)		diffusive	diffusive	diffusive	diffusive			GC-FID	PS 575-001	75		
Iodomethane	MDHS 96	2 ppm (12 mg/m ³)		10		20		8		GC-FID	ST 226-01	38		
Iron oxide (fume) (as Fe)	MDHS 91/2	5 mg/m ³	10 mg/m ³	960		2000		8		XRF	IOM 225-70A	108 FLT	225-1930	88
Iron salts (as Fe)	MDHS 91/2	1 mg/m ³	2 mg/m ³	960		2000		8		XRF	IOM 225-70A	108 FLT	225-1930	88
Isobutyl acetate	MDHS 72	150 ppm (724 mg/m ³)	187 ppm (903 mg/m ³)	24		50		8		TD, GC	ST 226-357	42		
Isobutyl acetate	MDHS 88	150 ppm (724 mg/m ³)	187 ppm (903 mg/m ³)	diffusive	diffusive	diffusive	diffusive			GC-FID	PS 575-002	75		
Isobutyl acetate	MDHS 96	150 ppm (724 mg/m ³)	187 ppm (903 mg/m ³)	10		20		8		GC-FID	ST 226-01	38		
Isocyanates (all) (as -NCO)	MDHS 25/4	0.02 mg/m ³	0.07 mg/m ³	960		2000		8		HPLC	IOM 225-79A	108 FLT	225-9011	64
Isoufuran	MDHS 80	50 ppm (383 mg/m ³)		24		50		8		GC-ECD	ST 226-357	42		
Isoufuran	MDHS 88	50 ppm (383 mg/m ³)		diffusive	diffusive	diffusive	diffusive			GC-FID	PS 575-002	75		
Isooctyl alcohol (mixed isomers)	MDHS 88	50 ppm (271 mg/m ³)		diffusive	diffusive	diffusive	diffusive			GC-FID	PS 575-002	75		
Isopentane	MDHS 88	600 ppm (1800 mg/m ³)		diffusive	diffusive	diffusive	diffusive			GC-FID	PS 575-002	75		
Isopentane	MDHS 96	600 ppm (1800 mg/m ³)		varies		varies		varies		GC-FID	ST 226-01	38		
Isopropyl acetate	MDHS 72		200 ppm (849 mg/m ³)	24		50		8		TD, GC	ST 226-357	42		
Isopropyl acetate	MDHS 88		200 ppm (849 mg/m ³)	diffusive	diffusive	diffusive	diffusive			GC-FID	PS 575-001	75		
Isopropyl acetate	MDHS 96		200 ppm (849 mg/m ³)	9		50		3		GC-FID	ST 226-01	38		
Isopropyl chloroformate			1 ppm (5.1 mg/m ³)											
Kaolin (respirable dust)	MDHS 14/4	2 mg/m ³		1056		varies		8		GR	CYC 225-69 IOM 225-70A FLT 225-58F	111 FLT 108 FOAM	225-58F 225-772	or 108
Ketene	OSHA CSI	0.5 ppm (0.87 mg/m ³)	1.5 ppm (2.6 mg/m ³)	50	15	1000	1000	50 min	15	CLR	IMP 225-36-2 IT 225-22	or IMP 225-36-5 67	67	
Lead & inorganic compounds	MDHS 91/2			960	30	2000	2000	8	15	XRF	IOM 225-70A	108 FLT	225-1930	88
Limestone (inhalable dust)	MDHS 14/4	10 mg/m ³		960		2000		8		GR	IOM 225-70A	108 FLT	225-58F	96
Limestone (respirable dust)	MDHS 14/4	4 mg/m ³		1056		2200		8		GR	CYC 225-69 IOM 225-70A FLT 225-58F	111 FLT 108 FOAM	225-58F 225-772	or 108
Liquified petroleum gas	OSHA CSI	1000 ppm (1750 mg/m ³)	1250 ppm (2180 mg/m ³)							DET TB	DT 810-100A			
Lithium hydride	MDHS 14/4	0.025 mg/m ³		1056		2200		8		GR	CYC 225-69 IOM 225-70A FLT 225-58F	111 FLT 108 FOAM	225-58F 225-772	or 108
Lithium hydroxide	OSHA ID-121		1 mg/m ³	960		2000		8		AA or AES	F/CST 225-3-01	88 C/HLD	225-1	102
Machine made mineral fibre (MMMF) (except for ceramic refractory)	MDHS 59/2	5 mg/m ³ & 2 fibres/ml		240		1000		8		GR + PCM	FLT/CL 225-54A	102 FLT	225-1913	88
Magnesite (inhalable dust)	MDHS 14/4	10 mg/m ³		960		2000		8		GR	IOM 225-70A	108 FLT	225-58F	96
Magnesite (respirable dust)	MDHS 14/4	4 mg/m ³		1056		2200		8		GR	CYC 225-69 IOM 225-70A FLT 225-58F	111 FLT 108 FOAM	225-58F 225-772	or 108
Magnesium oxide (as Mg) (inhalable dust)	MDHS 14/4	10 mg/m ³		960		2000		8		GR	IOM 225-70A	108 FLT	225-58F	96
Magnesium oxide (as Mg) (respirable dust)	MDHS 14/4	4 mg/m ³		1056		2200		8		GR	CYC 225-69 IOM 225-70A FLT 225-58F	111 FLT 108 FOAM	225-58F 225-772	or 108
Malathion	OSHA 62	10 mg/m ³		60		1000		1		GC-FPD	ST 226-30-16	38		
Maleic anhydride	MDHS 72	1 mg/m ³	3 mg/m ³	24		50		8		TD, GC	ST 226-357	42		
Manganese & inorganic compounds	MDHS 91/2	0.5 mg/m ³		960		2000		8		XRF	IOM 225-70A	108 FLT	225-1930	88
Manganese in welding fume	ISO 10882-1	0.5 mg/m ³				750				GR	H/SET 225-6200 CAL 225-6202	MINI	225-6201 225-8050	
Marble (total inhalable)	MDHS 14/4	10 mg/m ³		960		2000		8		GR	IOM 225-70A	108 FLT	225-58F	96
Marble (total respirable)	MDHS 14/4	4 mg/m ³		1056		2200		8		GR	CYC 225-69 IOM 225-70A FLT 225-58F	111 FLT 108 FOAM	225-58F 225-772	or 108
Mercaptoacetic acid	OSHA CSI	1 ppm (3.8 mg/m ³)		120		1000		2		HPLC-UV	IMP 225-36-1	67 IT	225-22	67
Mercury & compounds (except alkyl compounds)	NIOSH 6009	0.02 mg/m ³		48		200		4		AA	ST 226-17-1A	38 F/CST	225-3-01	88
Methacrylic acid	OSHA PV2005	20 ppm (72 mg/m ³)	40 ppm (143 mg/m ³)	24		100		4		HPLC-UV	ST 226-30-08	38		

See page 212 for abbreviations.

Chemical Hazard	Agency Reference	S A M P L I N G								Analytical Method	SKC Collecting Equipment and Page No.					
		WEL		Vol. (liter)		Rate (ml/min)		Time								
		TWA (ppm)	STEL (ppm)	TWA	STEL	TWA	STEL	TWA (hr)	STEL (min)							
Methanethiol	OSHA 26	0.5 ppm (1 mg/m ³)		20		200		100 min		GC-FPD	F/CST	225-9007	67	C/HLD	225-1	102
Methanol	MDHS 72	200 ppm (266 mg/m ³)	250 ppm (333 mg/m ³)	24		50		8		TD, GC	ST	226-358	42			
Methanol	MDHS 80	200 ppm (266 mg/m ³)	250 ppm (333 mg/m ³)	24		50		8		GC-ECD	ST	226-357	42			
Methanol	MDHS 96	200 ppm (266 mg/m ³)	250 ppm (333 mg/m ³)	5	3	20	200	4	15	GC-FID	ST	226-51	39			
2-Methoxyethanol	MDHS 72, 80	1 ppm (3 mg/m ³)		24		50		8		TD, GC	ST	226-358	42			
2-Methoxyethanol	MDHS 88	1 ppm (3 mg/m ³)		diffusive	diffusive	diffusive	diffusive			GC-FID	PS	575-002	75			
2-Methoxyethanol	MDHS 96	1 ppm (3 mg/m ³)		10		20		8		GC-FID	ST	226-01	38			
2-Methoxyethyl acetate	MDHS 72	1 ppm (5 mg/m ³)		8		15		8		TD, GC	ST	226-37	39			
2-Methoxyethyl acetate	MDHS 88	1 ppm (5 mg/m ³)		diffusive	diffusive	diffusive	diffusive			GC-FID	PS	575-002	or PS	575-001	75	
2-Methoxyethyl acetate	MDHS 96	1 ppm (5 mg/m ³)		10	7.5	20	500	8	15	GC-FID	ST	226-01	38			
1-Methoxypropan-2-ol	MDHS 72	100 ppm (375 mg/m ³)	150 ppm (560 mg/m ³)							TD, GC	ST	226-357	42			
1-Methoxypropan-2-ol	MDHS 88	100 ppm (375 mg/m ³)	150 ppm (560 mg/m ³)	diffusive	diffusive	diffusive	diffusive			GC-FID	PS	575-002	75			
1-Methoxypropyl acetate	MDHS 72	50 ppm (274 mg/m ³)	100 ppm (548 mg/m ³)							TD, GC	ST	226-358	38			
1-Methoxypropyl acetate	MDHS 88	50 ppm (274 mg/m ³)	100 ppm (548 mg/m ³)	diffusive	diffusive	diffusive	diffusive			GC-FID	PS	575-001	75			
1-Methoxypropyl acetate	MDHS 96	50 ppm (274 mg/m ³)	100 ppm (548 mg/m ³)	100 ppm (548 mg/m ³)						GC-FID	ST	226-01	38			
Methyl acetate	MDHS 72, 80	200 ppm (616 mg/m ³)	250 ppm (770 mg/m ³)	24		50		8		TD, GC	ST	226-358	42			
Methyl acetate	MDHS 88	200 ppm (616 mg/m ³)	250 ppm (770 mg/m ³)	diffusive	diffusive	diffusive	diffusive			GC-FID	PS	575-002	75			
Methyl acetate	MDHS 96	200 ppm (616 mg/m ³)	250 ppm (770 mg/m ³)	5	3	20	200	4	15	GC-FID	ST	226-01	38			
Methyl acrylate	MDHS 72	5 ppm (18 mg/m ³)	10 ppm (36 mg/m ³)	24		50		8		TD, GC	ST	226-357	42			
Methyl acrylate	MDHS 88	5 ppm (18 mg/m ³)	10 ppm (36 mg/m ³)	diffusive	diffusive	diffusive	diffusive			GC-FID	PS	575-002	75			
Methyl acrylate	MDHS 96	5 ppm (18 mg/m ³)	10 ppm (36 mg/m ³)	varies		varies		varies		GC-FID	ST	226-01	38			
Methyl cyanoacrylate	OSHA 55		0.3 ppm (1.4 mg/m ³)	12	3	100	200	8	15	HPLC-UV	ST	226-98	40			
Methyl ethyl ketone peroxide (MEKP)	OSHA 77		0.2 ppm (1.5 mg/m ³)	15	15		1000	15	15	HPLC-UV	ST	226-93	40			
Methyl isocyanate	OSHA 54		0.02 ppm	15		50		5		HPLC-FD	ST	NA SKC				
Methyl methacrylate	MDHS 72	50 ppm (208 mg/m ³)	100 ppm (416 mg/m ³)	24		50		8		TD, GC	ST	226-357	42			
Methyl methacrylate	MDHS 80	50 ppm (208 mg/m ³)	100 ppm (416 mg/m ³)	25		50		8		GC-ECD	ST	226-115	40			
Methyl methacrylate	MDHS 88	50 ppm (208 mg/m ³)	100 ppm (416 mg/m ³)	diffusive	diffusive	diffusive	diffusive			GC-FID	PS	575-002	75			
Methyl methacrylate	MDHS 96	50 ppm (208 mg/m ³)	100 ppm (416 mg/m ³)	5		20		4		GC-FID	ST	226-30-06	38			
1-Methyl-2-pyrrolidone	MDHS 72	25 ppm (103 mg/m ³)	75 ppm (309 mg/m ³)	24		50		8		TD, GC	ST	226-357	42			
1-Methyl-2-pyrrolidone	MDHS 96	25 ppm (103 mg/m ³)	75 ppm (309 mg/m ³)	10		200		8		GC-FID	ST	226-01	38			
N-Methyl-2-pyrrolidone	MDHS 72, 80	10 ppm (40 mg/m ³)	20 ppm (80 mg/m ³)	24		50		8		TD, GC	ST	226-357	42			
N-Methyl-2-pyrrolidone	MDHS 96	10 ppm (40 mg/m ³)	20 ppm (80 mg/m ³)	10		200		8		GC-FID	ST	226-01	38			
Methylacrylonitrile	OSHA 37	1 ppm (2.8 mg/m ³)		20		200		100 min		GC-NPD	ST	226-01	38			
N-Methylaniline	NIOSH 3511	0.5 ppm (2.2 mg/m ³)		100		1000		100 min		GC-FID	IMP IT	225-36-2 225-22	or IMP	225-36-5	67	
3-Methylbutan-1-ol	MDHS 88	100 ppm (366 mg/m ³)	125 ppm (458 mg/m ³)	diffusive	diffusive	diffusive	diffusive			GC-FID	PS	575-002	75			
3-Methylbutan-1-ol	MDHS 96	100 ppm (366 mg/m ³)	125 ppm (458 mg/m ³)	10	3	20(50)	200	8(3,3)	15	GC-FID	ST	226-01	38			
Methylcyclohexanol	MDHS 88	50 ppm (237 mg/m ³)	75 ppm (356 mg/m ³)	diffusive	diffusive	diffusive	diffusive			GC-FID	PS	575-002	75			
Methylcyclohexanol	MDHS 96	50 ppm (237 mg/m ³)	75 ppm (356 mg/m ³)	12		25		8		GC-FID	ST	226-01	38			
2-Methylcyclohexanone	MDHS 72, 80	50 ppm (233 mg/m ³)	75 ppm (350 mg/m ³)	24		50		8		TD, GC	ST	226-357	42			
2-Methylcyclohexanone	MDHS 96	50 ppm (233 mg/m ³)	75 ppm (350 mg/m ³)	4		20		3.3		GC-FID	ST	226-01	38			
4,4'-Methylenbis(ortho-chloroaniline) (MbOCA)	MDHS 75/2			200		500				HPLC	IOM	225-70A	108	FLT	225-58F	or
4,4'-Methylenedianiline (MDA)	MDHS 75/2	0.01 ppm (0.08 mg/m ³)		200		2000		100 min		HPLC	IOM	225-70A	108	FLT	225-58F	or
5-Methylheptane-3-one	MDHS 88	10 ppm (53 mg/m ³)	20 ppm (107 mg/m ³)	diffusive	diffusive	diffusive	diffusive			GC-FID	PS	575-001	or PS	575-002	75	
5-Methylheptane-3-one	MDHS 96	10 ppm (53 mg/m ³)	20 ppm (107 mg/m ³)	10	3	20	200	8	15	GC-FID	ST	226-01	38			
5-Methylhexan-2-one	MDHS 72	20 ppm (95 mg/m ³)	100 ppm (475 mg/m ³)	24		50		8		TD, GC	ST	226-357	42			
5-Methylhexan-2-one	MDHS 88	20 ppm (95 mg/m ³)	100 ppm (475 mg/m ³)	diffusive	diffusive	diffusive	diffusive			GC-FID	PS	575-002	75			
4-Methylpentan-2-ol	MDHS 88	25 ppm (106 mg/m ³)	40 ppm (170 mg/m ³)	diffusive	diffusive	diffusive	diffusive			GC-FID	PS	575-002	75			
4-Methylpentan-2-ol	MDHS 96	25 ppm (106 mg/m ³)	40 ppm (170 mg/m ³)	10	3	20	200	8	15	GC-FID	ST	226-01	38			
4-Methylpentan-2-one	MDHS 72, 80	50 ppm (208 mg/m ³)	100 ppm (416 mg/m ³)	24		50		8		TD, GC	ST	226-357	42			
4-Methylpentan-2-one	MDHS 88	50 ppm (208 mg/m ³)	100 ppm (416 mg/m ³)	diffusive	diffusive	diffusive	diffusive			GC-FID	PS	575-002	75			
4-Methylpentan-2-one	MDHS 96	50 ppm (208 mg/m ³)	100 ppm (416 mg/m ³)	10	3	20	200	8	15	GC-FID	ST	226-01	38			
2-Methylpentane-2,4-diol	OSHA PV2101	25 ppm (123 mg/m ³)	25 ppm (123 mg/m ³)		3		200		15	GC-FID	ST	226-01	38			
2-Methylpropan-1-ol	MDHS 72	50 ppm (154 mg/m ³)	75 ppm (231 mg/m ³)	24		50		8		TD, GC	ST	226-357	42			
2-Methylpropan-1-ol	MDHS 88	50 ppm (154 mg/m ³)	75 ppm (231 mg/m ³)	diffusive	diffusive	diffusive	diffusive			GC-FID	PS	575-002	75			
2-Methylpropan-1-ol	MDHS 96	50 ppm (154 mg/m ³)	75 ppm (231 mg/m ³)	10		20(50)		8(3,3)		GC-FID	ST	226-01	38			
Methyl-tert-butyl-ether	MDHS 88	50 ppm (183.5 mg/m ³)	100 ppm (367 mg/m ³)	diffusive	diffusive	diffusive	diffusive			GC-FID	PS	575-001	75			
Methyl-tert-butyl-ether	MDHS 96	50 ppm (183.5 mg/m ³)	100 ppm (367 mg/m ³)	96		200		8		GC-FID	ST	226-09	38			
Mica (total inhalable)	MDHS 14/4	10 mg/m ³		960		2000		8		GR	IOM	225-70A	108	FLT	225-58F	96
Mica (total respirable)	MDHS 14/4	0.8 mg/m ³		1056		2200		8		GR	CYC IOM	225-69 225-70A	111	FLT	225-58F 225-772	or 108
Molybdenum compounds (insoluble) (as Mo)	MDHS 91/2	10 mg/m ³	20 mg/m ³	240		1000		8		XRF	IOM	225-70A	108	FLT	225-1930	88
Molybdenum compounds (soluble) (as Mo)	MDHS 91/2	5 mg/m ³	10 mg/m ³	240		1000		8		XRF	IOM	225-70A	108	FLT	225-1930	88
Monochloroacetic acid	NIOSH 2008	0.3 ppm (1.2 mg/m ³)		48		100		8		IC-ECN	ST	226-47-01	39			
Nickel (insoluble compounds except nickel tetracarbonyl) (as Ni)	MDHS 91/2	0.5 mg/m ³		960		2000		8		XRF	IOM	225-70A	108	FLT	225-1930	88
Nickel (soluble compounds except nickel tetracarbonyl) (as Ni)	MDHS 91/2	0.1 mg/m ³		960		2000		8		XRF	IOM	225-70A	108	FLT	225-1930	88

See page 212 for abbreviations.

Sampling Guide — U.K. (HSE)

www.skinc.com for updates

Chemical Hazard	Agency Reference	S A M P L I N G								Analytical Method	SKC Collecting Equipment and Page No.					
		WEL		Vol. (liter)		Rate (ml/min)		Time								
		TWA (ppm)	STEL (ppm)	TWA	STEL	TWA	STEL	TWA (hr)	STEL (min)							
Nicotine	MDHS 96	0.5 mg/m ³	1.5 mg/m ³	360		1000		6		GC-NPD	ST	226-30-04	38			
Nitric acid	NIOSH 7903		1 ppm (2.6 mg/m ³)	48	3	200	200	4	15	IC	ST	226-10-03	38			
Nitrobenzene	MDHS 72	0.2 ppm (1 mg/m ³)		24		50		8		TD, GC	ST	226-357	42			
Nitrobenzene	MDHS 96	0.2 ppm (1 mg/m ³)		48		100		8		GC-FID	ST	226-10	38			
Nitrogen oxides	NIOSH 6014			1.5-6		25		1-4		VIS	ST	226-40	39			
Nitromethane	NIOSH 2527	100 ppm (254 mg/m ³)	150 ppm (381 mg/m ³)	2.4		20		2		GC-NSD	ST	226-111A	40			
2-Nitropropane	MDHS 96	5 ppm (19 mg/m ³)				20		1.5		GC-FID	ST	226-110	40			
di-n-Octyl phthalate	OSHA 104			240		1000		4		GC-FID	ST	226-56	38			
Oil mist	MDHS 84/2			960	30	2000	2000	8	15	GR	IOM	225-70A	108	FLT	225-1930	88
Orthophosphoric acid	NIOSH 7903	1 mg/m ³	2 mg/m ³	48	3	200	200	4	15	IC	ST	226-10-03	38			
Orthotolidine	MDHS 75/2			200		500				HPLC	IOM	225-70A	108	FLT	225-58F	96
										ST		226-35	38			
Osmium tetroxide (as Os)	MDHS 91/2	0.0002 ppm (0.002 mg/m ³)	0.0006 ppm (0.006 mg/m ³)	960		2000		8		XRF	IOM	225-70A	108	FLT	225-1930	88
Oxalic acid	OSHA PV2115	1 mg/m ³	2 mg/m ³	100		1000		100 min		IC	FLT	225-701	88	CST	225-3LF	97
											C/HLD	225-1	102			
2,2'-Oxydiethanol	NIOSH 5523	23 ppm (101 mg/m ³)		60		1000		1		GC-FID	ST	226-57	39			
Ozone	OSHA ID-214		0.2 ppm (0.4 mg/m ³)	90		500		3		IC	CF/CST	225-9014	64	C/HLD	225-1	102
Paracetamol (inhalable dust)	MDHS 14/4	10 mg/m ³		960		2000		8		GR	IOM	225-70A	108	FLT	225-58F	96
Paraffin wax (fume)	OSHA PV2047	2 mg/m ³	6 mg/m ³	100		1000		100 min		GC-FID	F/CST	225-706	96	C/HLD	225-1	102
Paraquat dichloride (ISO) (respirable dust)	MDHS 14/4	0.08 mg/m ³		1056		2200		8		GR	CYC	225-69	111	FLT	225-58F	or
										IOM	225-70A	108	FOAM	225-772	108	
										FLT	225-58F					
Pentacarbonyliron (as Fe)	OSHA CSI	0.01 ppm (0.08 mg/m ³)		480	30	2000	2000	4	15	CLR	IMP	225-36-2	or	IMP	225-36-5	67
										IT		225-22	67			
Pentaerythritol (inhalable dust)	MDHS 14/4	10 mg/m ³		960		2000		8		GR	IOM	225-70A	108	FLT	225-58F	96
Pentaerythritol (respirable dust)	MDHS 14/4	4 mg/m ³		1056		2200	(2000)	8		GR	CYC	225-69	111	FLT	225-58F	or
										IOM	225-70A	108	FOAM	225-772	108	
										FLT	225-58F					
Pentan-2-one	MDHS 88	200 ppm (716 mg/m ³)	250 ppm (895 mg/m ³)	diffusive	diffusive	diffusive	diffusive			GC-FID	PS	575-002	75			
Pentan-2-one	MDHS 96	200 ppm (716 mg/m ³)	250 ppm (895 mg/m ³)	10		20(50)		8(3.3)		GC-FID	ST	226-01	38			
Pentan-3-one	MDHS 88	200 ppm (716 mg/m ³)	250 ppm (895 mg/m ³)	diffusive	diffusive	diffusive	diffusive			GC-FID	PS	575-002	75			
Pentane	MDHS 72, 80	600 ppm (1800 mg/m ³)		varies		varies		varies		TD, GC	ST	226-358	42			
Pentane	MDHS 88	600 ppm (1800 mg/m ³)		diffusive	diffusive	diffusive	diffusive			GC-FID	PS	575-001	75			
Pentane	MDHS 96	600 ppm (1800 mg/m ³)		varies		varies		varies		GC-FID	ST	226-01	38			
Pentyl acetates (all isomers)	MDHS 88	50 ppm (270 mg/m ³)	100 ppm (541 mg/m ³)	diffusive	diffusive	diffusive	diffusive			GC-FID	PS	575-001	75			
Pentyl acetates (all isomers)	MDHS 96	50 ppm (270 mg/m ³)	100 ppm (541 mg/m ³)	varies		varies		varies		GC-FID	ST	226-01	38			
Peroxodisulphate salts	MDHS 79/2			960	30	2000	2000	8	15	IC	IOM	225-70A	108	FLT	225-1930	88
Phenol	MDHS 96	2 ppm (7.8 mg/m ³)	4 ppm (16 mg/m ³)	24	3	100	200	4	15	GC-FID	ST	226-95	40			
p-Phenyldiamine	OSHA 87	0.1 mg/m ³		100		1000		100 min		HPLC-UV	CF/CST	225-9004	64	C/HLD	225-1	102
2-Phenylpropene (alpha-methyl styrene)	MDHS 72	50 ppm (246 mg/m ³)	100 ppm (491 mg/m ³)	24		50		8		TD, GC	ST	226-357	42			
2-Phenylpropene (alpha-methyl styrene)	MDHS 88	50 ppm (246 mg/m ³)	100 ppm (491 mg/m ³)	diffusive	diffusive	diffusive	diffusive			GC-FID	PS	575-002	75			
2-Phenylpropene (alpha-methyl styrene)	MDHS 96	50 ppm (246 mg/m ³)	100 ppm (491 mg/m ³)	10	3	20	200	8	15	GC-FID	ST	226-10	38			
Phorate (ISO)	NIOSH 5600	0.05 mg/m ³	0.2 mg/m ³	240		1000		4		GC-FPD	ST	226-58	39			
Phosgene	OSHA 61	0.02 ppm (0.08 mg/m ³)	0.06 ppm (0.25 mg/m ³)	240		1000		4		GC-NPD	ST	226-117	40			
Phosphine	NIOSH 6002	0.1 ppm (0.14 mg/m ³)	0.2 ppm (0.28 mg/m ³)	12	3	100	200	2	15	UV-VIS	ST	226-165A	41			
Phosphorus pentachloride	OSHA CSI	0.1 ppm (0.87 mg/m ³)	0.2 ppm (2 mg/m ³)	48		200		4		CLR	F/CST	225-803	93	IMP	225-36-1	67
										IT		225-22	67	SCN	225-26	102
Phosphorus trichloride	OSHA CSI	0.2 ppm (1.1 mg/m ³)	0.5 ppm (2.9 mg/m ³)	240		1000		4		IC	IMP	225-36-2	or	IMP	225-36-5	67
										IT		225-22	67			
Phosphorus yellow	OSHA CSI	0.1 mg/m ³	0.3 mg/m ³	96		200		8		GC-FPD	ST	226-35-03	39			
Phthalic anhydride	MDHS 62/2	4 mg/m ³	12 mg/m ³	960	30	2000	2000	8	15	HPLC	IOM	225-70A	108	FLT	225-58F	96
										ST		226-35	38			
Picloram (ISO)	OSHA PV2049	10 mg/m ³	20 mg/m ³	60		1000		1		GR	FLT	225-5-37-P	93	CST	225-3LF	97
Piolic acid	OSHA CSI	0.1 mg/m ³	0.3 mg/m ³	180		1500		2		HPLC-UV	IOM	225-70A	108	FLT	225-1930	88
Piperazine	OSHA CSI	0.1 mg/m ³	0.3 mg/m ³	10		100		8		HPLC-UV	ST	226-30-18	38			
Piperazine dihydrochloride	MDHS 14/4	0.1 mg/m ³	0.3 mg/m ³	120		1000		8		GC-NPD	IOM	225-70A	108	FLT	225-58F	96
Piperidine	OSHA CSI	1 ppm (3.5 mg/m ³)		6		200		30 min		GC-FID	ST	226-01	38			
Plaster of Paris (inhalable dust)	MDHS 14/4	10 mg/m ³		960		2000		8		GR	IOM	225-70A	108	FLT	225-58F	96
Plaster of Paris (respirable dust)	MDHS 14/4	4 mg/m ³		1056		2200		8		GR	CYC	225-69	111	FLT	225-58F	or
										IOM	225-70A	108	FOAM	225-772	108	
										FLT	225-58F					
Polychlorinated biphenyls (PCB)	ASTM 4861	0.1 mg/m ³		960		2000		8		GC-ECD	PUF	226-124	41	PUF	226-92	40
Polychlorinated biphenyls (PCB)	OSHA PV2088	0.1 mg/m ³		60		1000		1		GC-ECD	ST	226-30-16	38			
Polyvinylchloride (inhalable dust)	MDHS 14/4	10 mg/m ³		960		2000		8		GR	IOM	225-70A	108	FLT	225-58F	96
Polyvinylchloride (respirable dust)	MDHS 14/4	4 mg/m ³		1056		2200		8		GR	CYC	225-69	111	FLT	225-58F	or
										IOM	225-70A	108	FOAM	225-772	108	
										FLT	225-58F					

See page 212 for abbreviations.

Chemical Hazard	Agency Reference	S A M P L I N G								Analytical Method	SKC Collecting Equipment and Page No.			
		WEL		Vol. (liter)		Rate (ml/min)		Time						
		TWA (ppm)	STEL (ppm)	TWA	STEL	TWA	STEL	TWA (hr)	STEL (min)					
Portland cement (inhalable dust)	MDHS 14/4	10 mg/m ³		960		2000		8		GR	IOM 225-70A	108 FLT	225-58F	96
Portland cement (respirable dust)	MDHS 14/4	4 mg/m ³		1056		2200		8		GR	CYC 225-69 IOM 225-70A FLT 225-58F	111 FLT 108 FOAM	225-58F 225-772	or 96
Potassium hydroxide	MDHS 14/4		2 mg/m ³	10		2000		5		AA or AES	IOM 225-70A	108 FLT	225-1930	88
Prop-2-yn-1-ol	OSHA 97	1 ppm (2.3 mg/m ³)	3 ppm (7 mg/m ³)	6		50		2		GC-ECD	ST 226-178		41	
Propan-1-ol	MDHS 72	200 ppm (500 mg/m ³)	250 ppm (625 mg/m ³)	24		50		8		TD, GC	ST 226-358		42	
Propan-1-ol	MDHS 72	200 ppm (500 mg/m ³)	250 ppm (625 mg/m ³)	24		50		8		TD, GC	ST 226-358		42	
Propan-1-ol	MDHS 88	200 ppm (500 mg/m ³)	250 ppm (625 mg/m ³)	diffusive	diffusive	diffusive	diffusive			GC-FID	PS 575-001	or PS	575-002	75
Propan-1-ol	MDHS 88	200 ppm (500 mg/m ³)	250 ppm (625 mg/m ³)	diffusive	diffusive	diffusive	diffusive			GC-FID	PS 575-001	or PS	575-002	75
Propan-1-ol	MDHS 96	200 ppm (500 mg/m ³)	250 ppm (625 mg/m ³)	varies				varies		GC-FID	ST 226-01		38	
Propan-1-ol	MDHS 96	200 ppm (500 mg/m ³)	250 ppm (625 mg/m ³)	10	3	20(50)	200	8(3.3)	15	GC-FID	ST 226-01		38	
Propan-2-ol	MDHS 72	400 ppm (999 mg/m ³)	500 ppm (1250 mg/m ³)	24		50		8		TD, GC	ST 226-358		42	
Propan-2-ol	MDHS 88	400 ppm (999 mg/m ³)	500 ppm (1250 mg/m ³)	diffusive	diffusive	diffusive	diffusive			GC-FID	PS 575-002		75	
Propan-2-ol	MDHS 96	400 ppm (999 mg/m ³)	500 ppm (1250 mg/m ³)	3	3	20	200	2.5	15	GC-FID	ST 226-01		38	
Propane-1,2-diol (particulates)	MDHS 14/4	10 mg/m ³		960		2000		8		GR	IOM 225-70A	108 FLT	225-58F	96
Propane-1,2-diol (total vapour & particulates)	OSHA PV2051	150 ppm (474 mg/m ³)		60	15	1000	1000	1	15	GC-FID	ST 226-57		39	
Propionic acid	OSHA CSI	10 ppm (31 mg/m ³)	15 ppm (46 mg/m ³)	10		20		8		GC-FID	ST 226-15		38	
Propoxur (ISO)	NIOSH 5801	0.5 mg/m ³	2 mg/m ³	240		1000		4		HPLC-UV	ST 226-58	or ST	226-30-16	39
Propranolol	MDHS 14/4	2 mg/m ³	6 mg/m ³	960		2000		8		GR	IOM 225-70A	108 FLT	225-58F	96
n-Propyl acetate	MDHS 72	200 ppm (849 mg/m ³)	250 ppm (1060 mg/m ³)	24		50		8		TD, GC	ST 226-357		42	
n-Propyl acetate	MDHS 88	200 ppm (849 mg/m ³)	250 ppm (1060 mg/m ³)	diffusive	diffusive	diffusive	diffusive			GC-FID	PS 575-001		75	
n-Propyl acetate	MDHS 96	200 ppm (849 mg/m ³)	250 ppm (1060 mg/m ³)	10	3	20(50)	200	8(3.3)	15	GC-FID	ST 226-01		38	
Propylene oxide	MDHS 72	5 ppm (12 mg/m ³)		24		50		8		TD, GC	ST 226-357		42	
Propylene oxide	MDHS 80, 88	5 ppm (12 mg/m ³)		diffusive	diffusive	diffusive	diffusive			GC-FID	PS 575-001		75	
Propylene oxide	MDHS 96	5 ppm (12 mg/m ³)		5		20		4.2		GC-FID	ST 226-01		38	
Pulverized fuel ash (inhalable)	MDHS 14/4	10 mg/m ³		960		2000		8		GR	IOM 225-70A	108 FLT	225-58F	96
Pulverized fuel ash (respirable)	MDHS 14/4	4 mg/m ³		1056		2200	(2000)	8		GR	CYC 225-69 IOM 225-70A FLT 225-58F	111 FLT 108 FOAM	225-58F 225-772	or 96
Pyrethrum	OSHA 70	1 mg/m ³		60		1000		1		GC-ECD	ST 226-30-16		38	
Pyridine	MDHS 72	5 ppm (16 mg/m ³)	10 ppm (33 mg/m ³)	24		50		8		TD, GC	ST 226-357		42	
Pyridine	MDHS 88	5 ppm (16 mg/m ³)	10 ppm (33 mg/m ³)	diffusive	diffusive	diffusive	diffusive			GC-FID	PS 575-001		75	
Pyridine	MDHS 96	5 ppm (16 mg/m ³)	10 ppm (33 mg/m ³)	40		100		8		GC-FID	ST 226-01		38	
2-Pyridylamine	OSHA PV2143	0.5 ppm (2 mg/m ³)	2 ppm (7.8 mg/m ³)	240		1000		4		GC-NPD	F/CST 225-9004		65	
Pyrocatechol	OSHA PV2014	5 ppm (23 mg/m ³)		100		1000		100 min		HPLC-UV	ST 226-57		39	
Refractory ceramic & special purpose fibres		5 mg/m ³ (1 fibre/mm)		240		1000		8		PCM	FLT/CL 225-54A	102 FLT	225-1913	88
Rhodium (metal fume & dust) as Rh	MDHS 91/2	0.1 mg/m ³	0.3 mg/m ³	960	30	2000	2000	8	15	XRF	IOM 225-70A	108 FLT	225-1930	88
Rhodium (soluble salts) as Rh	MDHS 91/2	0.001 mg/m ³	0.003 mg/m ³	960	30	2000	2000	8	15	XRF	IOM 225-70A	108 FLT	225-1930	88
Rosin-based solder flux fume	MDHS 83/3	0.05 mg/m ³	0.15 mg/m ³	960	30	2000	2000	8	15	GC-FID	CST 225-8050K (kit)	FLT	225-8050	96
Rotenone (ISO)	NIOSH 5007	5 mg/m ³	10 mg/m ³	120		1000		2		HPLC-UV	FLT 225-17-01 C/HLD 225-1	94 CST	225-2LF	97
Rouge (total inhalable)	MDHS 14/4	10 mg/m ³		960		2000		8		GR	IOM 225-70A	108 FLT	225-58F	96
Rouge (total respirable)	MDHS 14/4	4 mg/m ³		1056		2200	(2000)	8		GR	CYC 225-69 IOM 225-70A FLT 225-58F	111 FLT 108 FOAM	225-58F 225-772	or 108
Rubber fume	MDHS 47/3	0.6 mg/m ³		960	500	2000	2000	8		GR + SE	IOM 225-70A	108 FLT	225-58F	96
Rubber process dust	MDHS 14/4	6 mg/m ³		960	30	2000	2000	8	15	GR	IOM 225-70A	108 FLT	225-58F	96
Selenium & compounds (except hydrogen selenide) (as Se)	MDHS 91/2	0.1 mg/m ³		960		2000		8		XRF	IOM 225-70A	108 FLT	225-1930	88
Silane		0.5 ppm (0.67 mg/m ³)	1 ppm (1.3 mg/m ³)	480		1000		4		AAS-GF	IMP 225-36-2 IT 225-22	67 IMP	225-36-5	67
Silica amorphous (inhalable dust)	MDHS 14/4	6 mg/m ³		960	30	2000	2000	8	15	GR	IOM 225-70A	108 FLT	225-5-25	93
Silica amorphous (respirable dust)	MDHS 14/4	2.4 mg/m ³		1056	30	2200	2200/2000	8	15	GR	CYC 225-69 IOM 225-70A FLT 225-5-25	111 FLT 108 FOAM	225-5-25 225-772	93 108
Silica fused (respirable dust)	MDHS 14/4	0.08 mg/m ³		1056	33	2200	2200/2000	8	15	GR	CYC 225-69 IOM 225-70A FLT 225-5-25	111 FLT 108 FOAM	225-5-25 225-772	93 108
Silica, crystalline (respirable)	MDHS 101	0.1 mg/m ³		1056		2200	(2000)	8		IR / XRD	CYC 225-69 IOM 225-70A FLT 225-5-25	111 FLT 108 FOAM	225-5-25 225-772	or 108
Silica, crystalline (respirable)	MDHS 14/4	0.1 mg/m ³		1056		2200	(2000)	8		GR	CYC 225-69 IOM 225-70A FLT 225-5-25	111 FLT 108 FOAM	225-5-25 225-772	93 108
Silicone carbide (not whiskers) (total inhalable)	MDHS 14/4	10 mg/m ³		960		2000		8		GR	IOM 225-70A	108 FLT	225-58F	96

See page 212 for abbreviations.

Sampling Guide — U.K. (HSE)

www.skinc.com for updates

Chemical Hazard	Agency Reference	S A M P L I N G								Analytical Method	SKC Collecting Equipment and Page No.					
		WEL		Vol. (liter)		Rate (ml/min)		Time								
		TWA (ppm)	STEL (ppm)	TWA	STEL	TWA	STEL	TWA (hr)	STEL (min)							
Silicone carbide (not whiskers) (total respirable)	MDHS 14/4	4 mg/m ³		1056		2200		8		GR	CYC IOM FLT	225-69 225-70A 225-58F	111 108 108	FLT FOAM FLT	225-58F 225-772 225-58F	or 108
Silver (soluble compounds as Ag)	MDHS 91/2	0.01 mg/m ³		960	30	2000	2000	8	15	XRF	IOM	225-70A	108	FLT	225-1930	88
Silver, metallic	MDHS 91/2	0.1 mg/m ³		240	60	2000	2000	0.5	2	XRF	IOM	225-70A	108	FLT	225-1930	88
Sodium azide (as NaN ₃)	OSHA ID-211	0.1 mg/m ³	0.3 mg/m ³		5		1000		5 min	IC-UV	ST CST C/HLD	226-55 225-2LF 225-1	39 97 102	FLT SPC 102	225-5-37-P 225-23	93 102
Sodium hydrogen sulphite	OSHA ID-121	5 mg/m ³		960		2000		8		AA or AES	F/CST	225-3-01	88	C/HLD	225-1	102
Sodium hydroxide	MDHS 14/4		2 mg/m ³	960		2000		8		GR	IOM	225-70A	108	FLT	225-58F	96
Sodium-2-(2,4-dichlorophenoxy) ethyl sulphate	OSHA CSI	10 mg/m ³	20 mg/m ³	varies	varies	varies	varies			CLR	IOM	225-70A	108	FLT	225-1930	88
Softwood dust	MDHS 14/4	5 mg/m ³		960	30	2000	2000	8	15	GR	IOM	225-70A	108	FLT	225-58F	96
Starch (respirable)	MDHS 14/4	4 mg/m ³		1056		2200 (2000)		8		GR	CYC IOM FLT	225-69 225-70A 225-58F	111 108 108	FLT FOAM FLT	225-58F 225-772	or 108
Starch (total inhalable)	MDHS 14/4	10 mg/m ³		960		2000		8		GR	IOM	225-70A	108	FLT	225-58F	96
Styrene	MDHS 72, 80	100 ppm (430 mg/m ³)	250 ppm (1080 mg/m ³)	24		50		8		TD, GC	ST	226-357	42			
Styrene	MDHS 88	100 ppm (430 mg/m ³)	250 ppm (1080 mg/m ³)	diffusive	diffusive	diffusive	diffusive	8	15	GC-FID	PS	575-006	75			
Styrene	MDHS 96	100 ppm (430 mg/m ³)	250 ppm (1080 mg/m ³)	10	5	20(50)	330	8(3.3)	15	GC-FID	ST	226-01	38			
Subtilisins (Bacillus subtilis BPN & Carlsberg)	OSHA CSI	0.00004 mg/m ³						Bulk		Bulk	Bulk					
Sucrose	MDHS 14/4	10 mg/m ³	20 mg/m ³	960		2000		8		GR	IOM	225-70A	108	FLT	225-58F	96
Sulfotep (tetraethyl dithiopyrophosphate, TEPP)	OSHA CSI Σ	0.1 mg/m ³		480		1000		100 min		GC-FPD	ST	226-30-16	38			
Sulphuric acid	NIOSH 7903	0.05 mg/m ³		48		200		4		IC	ST	226-10-03	38			
Sulphuric acid	OSHA 113	0.05 mg/m ³		480		2000		4		IC	PPI IS	225-3861 225-388		FLT SP	225-5 225-27	93 103
Sulphuryl difluoride	NIOSH 6012	5 ppm (21 mg/m ³)	10 ppm (42 mg/m ³)	10		20		8		IC-ECN	ST	226-16	38			
Talc (respirable dust)	MDHS 14/4	1 mg/m ³		1056	33	2200	2200	8	15	GR	CYC IOM FLT	225-69 225-70A 225-58F	111 108 108	FLT FOAM FLT	225-58F 225-772 225-58F	or 108
Tantalum	MDHS 91/2	5 mg/m ³	10 mg/m ³	240	6	2000	2000	0.5	2	XRF	IOM	225-70A	108	FLT	225-1930	88
Tellurium & compounds (except hydrogen telluride) as Te	MDHS 91/2	0.1 mg/m ³		960		2000		8		XRF	IOM	225-70A	108	FLT	225-1930	88
Terphenyls (all isomers)	OSHA CSI		0.5 ppm (4.8 mg/m ³)		8.5		1700		5	HPLC-FD	F/CST	225-709	96	C/HLD	225-1	102
1,1,2,2-Tetrabromomethane	MDHS 96	0.5 ppm (7.2 mg/m ³)		96		200		8		GC-FID	ST	226-10	38			
Tetracarbonylnickel	OSHA CSI		0.1 ppm (0.24 mg/m ³)	480		1000		8		AA-GF	F/CST IMP	225-709 225-36-2	96 67	C/HLD IT	225-1 225-22	102 67
1,1,2,2-Tetrachloroethane	MDHS 88		diffusive	diffusive	diffusive	diffusive	diffusive	8	15	GC-FID	PS	575-001	75			
1,1,2,2-Tetrachloroethane	MDHS 96		10	3	20	200		8	15	GC-FID	ST	226-01	38			
Tetrachloroethylene	MDHS 72, 80	50 ppm (345 mg/m ³)	100 ppm (689 mg/m ³)	24		50		8		TD, GC	ST	226-357	42			
Tetrachloroethylene	MDHS 88	50 ppm (345 mg/m ³)	100 ppm (689 mg/m ³)	diffusive	diffusive	diffusive	diffusive	8	15	GC-FID	PS	575-002	75			
Tetrachloroethylene	MDHS 96	50 ppm (345 mg/m ³)	100 ppm (689 mg/m ³)	3		20		2.5		GC-FID	ST	226-01	38			
Tetrachlorophthalic anhydride	MDHS 62/2			240	7.5	500	500	8	15	HPLC	IOM ST	225-70A 226-35	108 38	FLT	225-58F	96
Tetraethyl lead (as Pb)				960	120	2000	2000	8	60	AA	IOM	225-70A	108	FLT	225-1930	88
Tetrahydrofuran	MDHS 88	50 ppm (150 mg/m ³)	100 ppm (300 mg/m ³)	diffusive	diffusive	diffusive	diffusive			GC-FID	PS	575-001	75			
Tetrahydrofuran	MDHS 96	50 ppm (150 mg/m ³)	100 ppm (300 mg/m ³)	9	1.5	20(50)	100	7(3)	15	GC-FID	ST	226-01	38			
Tetrasodium pyrophosphate	OSHA ID-111	5 mg/m ³		960		2000		8		GR IC	FLT C/HLD	225-5-37-P 225-1	93 102	CST	225-2LF	97
Thallium (soluble compounds) (as Tl)	MDHS 91/2	0.1 mg/m ³		960		2000		8		XRF	IOM	225-70A	108	FLT	225-1930	88
Thionyl chloride	OSHA CSI		1 ppm (4.9 mg/m ³)		15		1000		15	IC	IMP IT	225-36-2 225-22		or IMP	225-36-5	67
Tin compounds (inorganic except SnH ₄) (as Sn)	MDHS 91/2	2 mg/m ³	4 mg/m ³	960		2000		8		XRF	IOM	225-70A	108	FLT	225-1930	88
Tin compounds (organic except cyhexatin) (ISO) (as Sn)	NIOSH 5504	0.1 mg/m ³	0.2 mg/m ³	480		1000		8		HPLC AA-GF	ST C/HLD	226-30 225-1	38 102	F/CST	225-706	96
Titanium dioxide - respirable	MDHS 14/4	4 mg/m ³		1056		2200 (2000)		8		GR	CYC IOM FLT	225-69 225-70A 225-58F	111 108 108	FLT FOAM FLT	225-58F 225-772	or 108
Titanium dioxide (inhalable)	MDHS 14/4	10 mg/m ³		960		2000		8		GR	IOM	225-70A	108	FLT	225-58F	96
Toluene	MDHS 72	50 ppm (191 mg/m ³)	100 ppm (384 mg/m ³)	24		50		8		TD, GC	ST	226-357	42			
Toluene	MDHS 80	50 ppm (191 mg/m ³)	100 ppm (384 mg/m ³)	24		50		8		GC-ECD	ST	226-357	or	ST	226-358	42
Toluene	MDHS 88	50 ppm (191 mg/m ³)	100 ppm (384 mg/m ³)	diffusive	diffusive	diffusive	diffusive	8	15	GC-FID	PS	575-001	75			
Toluene	MDHS 96	50 ppm (191 mg/m ³)	100 ppm (384 mg/m ³)	6	3	100	200	1	15	GC-FID	ST	226-01	38			
o-Toluidine	MDHS 75/2	0.2 ppm (0.89 mg/m ³)		200		500				HPLC	IOM ST	225-70A 226-35	108	FLT	225-58F	96
o-Toluidine	MDHS 96	0.2 ppm (0.89 mg/m ³)		48		100		8		GC-FID	ST	226-10	38			
o-Toluidine	MDHS 96			48		100		8		GC-FID	ST	226-10	38			
Tributyl phosphate (all isomers)	NIOSH 5034	5 mg/m ³	5 mg/m ³	90		1500		1		GC-FPD	F/CST	225-3-01	88	C/HLD	225-1	102
1,2,4-Trichlorobenzene	MDHS 80	1 ppm	5 ppm	varies		varies		varies		GC-ECD	FLT CST	225-17-03	94	ST C/HLD	226-30-04 225-1	38 102

See page 212 for abbreviations.

Chemical Hazard	Agency Reference	S A M P L I N G								Analytical Method	SKC Collecting Equipment and Page No.		
		WEL		Vol. (liter)		Rate (ml/min)		Time					
		TWA (ppm)	STEL (ppm)	TWA	STEL	TWA	STEL	TWA (hr)	STEL (min)				
1,1,1-Trichloroethane	MDHS 72, 80	100 ppm (555 mg/m ³)	200 ppm (1110 mg/m ³)	24		50		8		TD, GC	ST 226-358	42	
1,1,1-Trichloroethane	MDHS 88	100 ppm (555 mg/m ³)	200 ppm (1110 mg/m ³)	diffusive	diffusive	diffusive	diffusive			GC-FID	PS 575-001	75	
1,1,1-Trichloroethane	MDHS 96	100 ppm (555 mg/m ³)	200 ppm (1110 mg/m ³)		3		200		15	GC-FID	ST 226-01	38	
1,1,2-Trichloroethane	MDHS 72			24		50		8		TD, GC	ST 226-358	42	
1,1,2-Trichloroethane	MDHS 88			diffusive	diffusive	diffusive	diffusive			GC-FID	PS 575-001	75	
1,1,2-Trichloroethane	MDHS 96			10	3	20	200	8	15	GC-FID	ST 226-01	38	
Trichloroethylene	MDHS 72, 80	100 ppm (550 mg/m ³)	150 ppm (820 mg/m ³)	24		50		8		TD, GC	ST 226-357	42	
Trichloroethylene	MDHS 88	100 ppm (550 mg/m ³)	150 ppm (820 mg/m ³)	diffusive	diffusive	diffusive	diffusive			GC-FID	PS 575-001	75	
Trichloroethylene	MDHS 96	100 ppm (550 mg/m ³)	150 ppm (820 mg/m ³)	10	3	20(50)	200	8(3,3)	15	GC-FID	ST 226-01	38	
Trichloronitromethane	OSHA PV2103	0.1 ppm (0.68 mg/m ³)	0.3 ppm (2.1 mg/m ³)	3		200		15 min		GC-ECD	ST 226-93	40	
Triethylamine	OSHA PV2060	2 ppm (8 mg/m ³)	4 ppm (17 mg/m ³)	5	3	100	200	50	15	GC-FID	ST 226-98	40	
Triglycidyl isocyanurate (TGIC)	MDHS 85/2	0.1 mg/m ³		960	30	2000	2000	8	15	HPLC	IOM 225-70A	108 FLT	225-58F 96
Trimellitic anhydride	MDHS 62/2	0.04 mg/m ³	0.12 mg/m ³	240	7.5	500	500	8	15	HPLC	IOM 225-70A	108 FLT	225-58F 96
										ST	226-35	38	
Trimethylbenzenes (all isomers or mixtures)	MDHS 72, 80	25 ppm (125 mg/m ³)		24		50		8		TD, GC	ST 226-357	42	
Trimethylbenzenes (all isomers or mixtures)	MDHS 88	25 ppm (125 mg/m ³)		diffusive	diffusive	diffusive	diffusive			GC-FID	PS 575-001	75	
3,5,5-Trimethylcyclohex-2-enone	MDHS 72		5 ppm (29 mg/m ³)	24		50		8		TD, GC	ST 226-357	42	
3,5,5-Trimethylcyclohex-2-enone	MDHS 88		5 ppm (29 mg/m ³)	diffusive	diffusive	diffusive	diffusive			GC-FID	PS 575-002	75	
3,5,5-Trimethylcyclohex-2-enone	MDHS 96		5 ppm (29 mg/m ³)	10		20(50)		8(3,3)		GC-FID	ST 226-01	38	
2,4,6-Trinitrotoluene	OSHA 44	0.5 mg/m ³		60		1000		1		GC-TEA-EAP	ST 226-56	39	
Tri- <i>o</i> -tolyl phosphate	NIOSH 5037	0.1 mg/m ³	0.3 mg/m ³	90		1000		1.5		GC-FPD	F/CST 225-3-01	88 C/HLD	225-1 102
Triphenyl phosphate	NIOSH 5038	3 mg/m ³	6 mg/m ³	240		1000		4		GC-FPD	F/CST 225-3-01	88 C/HLD	225-1 102
Tungsten & insoluble compounds (as W) & others	MDHS 91/2	5 mg/m ³	10 mg/m ³	960		2000		8		XRF	IOM 225-70A	108 FLT	225-1930 88
Tungsten & soluble compounds (as W)	MDHS 91/2	1 mg/m ³	3 mg/m ³	960		2000		8		XRF	IOM 225-70A	108 FLT	225-1930 88
Turpentine	NIOSH 1551	100 ppm (566 mg/m ³)	150 ppm (850 mg/m ³)	10		20(50)		8(3,3)		GC-FID	ST 226-01	38	
Vanadium pentoxide	MDHS 91/2	0.05 mg/m ³		960		2000		8		XRF	IOM 225-70A	108 FLT	225-1930 88
Vanadium pentoxide	NIOSH 7504	0.05 mg/m ³		600		2600		4		XRD	F/CST 225-803	93 CYC	225-01-02 111
										C/HLD	225-1	102	
Vinyl chloride	MDHS 96	3 ppm (7.8 mg/m ³)		5		50		1.6		GC-FID	ST 226-01	38	
Vinylidene chloride	MDHS 88	10 ppm (40 mg/m ³)		diffusive	diffusive	diffusive	diffusive			GC-FID	PS 575-001	75	
Vinylidene chloride	MDHS 96	10 ppm (40 mg/m ³)		5		20		4		GC-FID	ST 226-01	38	
Welding fume	ISO 10882-1					750				GR	H/SET 225-6200	MINI	225-6201
										CAL	225-6202	FLT	225-8050
Wood dust (inhalable)	MDHS 14/4			1056		2000		8		GR	IOM 225-70A	108 FLT	225-58F 96
Wood dust (respirable)	MDHS 14/4			1056		2200		8		GR	CYC 225-69	111 FLT	225-58F or
											IOM 225-70A	108 FOAM	225-772 108
											FLT 225-58F	96	
Wool process dust	MDHS 14/4	10 mg/m ³		960		2000		8		GR	IOM 225-70A	108 FLT	225-58F 96
Xylene (<i>o</i> -, <i>m</i> -, <i>p</i> -, or mixed isomers)	MDHS 72, 80	50 ppm (220 mg/m ³)	100 ppm (441 mg/m ³)	24		50		8		TD, GC	ST 226-357	42	
Xylene (<i>o</i> -, <i>m</i> -, <i>p</i> -, or mixed isomers)	MDHS 88	50 ppm (220 mg/m ³)	100 ppm (441 mg/m ³)	diffusive	diffusive	diffusive	diffusive			GC-FID	PS 575-001	75	
Xylene (<i>o</i> -, <i>m</i> -, <i>p</i> -, or mixed isomers)	MDHS 96	50 ppm (220 mg/m ³)	100 ppm (441 mg/m ³)	21	3	50	200	7	15	GC-FID	ST 226-01	38	
Yttrium	MDHS 91/2	1 mg/m ³	3 mg/m ³	960		2000		8		XRF	IOM 225-70A	108 FLT	225-1930 88
Zinc chloride (fume)	MDHS 91/2	1 mg/m ³	2 mg/m ³	960		2000		8		XRF	IOM 225-70A	108 FLT	225-1930 88
Zinc distearate (inhalable dust)	MDHS 91/2	10 mg/m ³	20 mg/m ³	960		2000		8		XRF	IOM 225-70A	108 FLT	225-1930 88
Zinc distearate (respirable dust)	MDHS 91/2	4 mg/m ³		1056		2200 (2000)		8		XRF	CYC 225-69	111 FLT	225-1930 or
											IOM 225-70A	108 FOAM	225-772 108
											FLT 225-1930	88	
Zinc oxide	MDHS 14/4			960		2000		8		GR	IOM 225-70A	108 FLT	225-58F 96
Zirconium compounds (as Zr)	MDHS 91/2	5 mg/m ³	10 mg/m ³	960		2000		8		XRF	IOM 225-70A	108 FLT	225-1930 88

√ Use two Cat. No. 226-35 tubes.

¶ Use two Cat. No. 226-36 tubes.

§ Use Cat. No. 226-44-02 if RH is 50% or greater.

† Filter requires coating.

£ The filter is not analysed.

Σ Contact HSE for more details on sampling and analysis.

Sampling Guide

www.skinc.com for updates

A

Chemical Hazard	Agency Reference	Chem F File	SAMPLING ∞								Analytical Method	SKC Collecting Equipment & Page Number							
			Agency Standard		Vol. (liter)		Rate (ml/min)		Time										
			TWA (ppm)	CLG/STEL (ppm)	TWA (Sample Time or Air Volume)	CLG/STEL	TWA (Flow/Sampling Rate)	CLG/STEL	TWA (hrs)	CLG/STEL (min)									
Abietic acid	OSHA CSI				200		2000			1.6		HPLC-UV	F/CST	225-709	96	C/HLD	225-1	102	
Absidia species (fungi, molds, spores)	OSHA CSI				120		1000			2		varies	F/CST	225-3-01	90	C/HLD	225-1	102	
Absidia species (fungi, molds, spores)	OSHA CSI				141.5		28300			5 min		varies	BI	225-9611	120				
Acenaphthene (Polynuclear Aromatic Hydrocarbons by GC-MS)	ASTM D 6209				350 m³ (max)		225 L/min			1-24		GC-MS	PUF	226-131	45	FLT	225-1808	95	
Acenaphthene (Polynuclear Aromatic Hydrocarbons by GC)	NIOSH 5515				480		2000			4		GC-FID	F/CST	225-1713	94	ST	226-30-04	38	
Acenaphthene (Polynuclear Aromatic Hydrocarbons by HPLC)	NIOSH 5506				480		2000			4		HPLC-UV	F/CST	225-1713	94	ST	226-30-04	38	
Acenaphthylene (Polynuclear Aromatic Hydrocarbons by GC)	NIOSH 5515				480		2000			4		GC-FID	F/CST	225-1713	94	ST	226-30-04	38	
Acenaphthylene (Polynuclear Aromatic Hydrocarbons by GC-MS)	ASTM D 6209				350 m³ (max)		225 L/min			1-24		GC-MS	PUF	226-131	45	FLT	225-1808	95	
Acenaphthylene (Polynuclear Aromatic Hydrocarbons by HPLC)	NIOSH 5506				480		2000			4		HPLC-UV	F/CST	225-1713	94	ST	226-30-04	38	
Acetaldehyde	ASTM D 5197				varies		500-1200			5 min-24 hrs		HPLC-UV	ST	226-120 °		or	ST	226-119	40
Acetaldehyde	NIOSH 2538		LFC		10		20			8		GC-FID	ST	226-27				38	
Acetaldehyde	NIOSH 3507		LFC		60		125			8		HPLC	IMP	225-36-2	67	IT	225-22	67	
Acetaldehyde	OSHA 68	1007		200	3	0.75	50	50		1	15	GC-NPD	ST	226-27				38	
Acetaldehyde (Aldehydes, Screening)	NIOSH 2539		LFC		5		10			8		GC-FID & GC-MS	ST	226-118				40	
Acetamide	OSHA PV2084				10		20(50)			8(3.3)		GC-NPD	ST	226-10				38	
Acetates (screening)	NIOSH 2549				5		20			4		GC-MS	ST	226-330				42	
Acetic acid	EPA TO-17	1689			1 L & 4 L		16.7 ml/min & 66.7 ml/min					TD, GC	ST	226-300 Series	42	TH	224-26-02	51	
Acetic acid	NIOSH 1603		10	15	24		50			8		GC-FID	ST	226-01				38	
Acetic acid	OSHA ID 1869G		10		48		200			4		IC or GC-FID	ST	226-01				38	
Acetic acid	OSHA PV2119				48		200			4		IC or GC-FID	ST	226-01				38	
Acetic anhydride	NIOSH 3506			5	90		1000			1.5		VAS	IMP	225-36-2	67	IT	225-22	67	
Acetic anhydride	OSHA 102	1392	5		7.5	7.5	50	500		2.5	15	GC-NPD	CF/CST	225-9010 ††	64	C/HLD	225-1	102	
Acetic anhydride	OSHA 82	1391	5		0.75		50			15 min		GC-NPD	CF/CST	225-9009	64	C/HLD	225-1	102	
Acetoin	NIOSH 2558				1-10		10-200			varies		GC-FID	ST	NA SKC					
Acetoin (acetyl methyl carbinol)	OSHA 1012		0.05		9	3	50	200		3	15	GC-FID	ST	226-183				41	
Acetoin (acetyl methyl carbinol)	OSHA 1013		0.05		9	3	50	200		3	15	GC-FID	ST	226-183				41	
Acetone	ASTM D 5197				varies		500-1200			5 min-24 hrs		HPLC-UV	ST	226-120 °		or	ST	226-119	40
Acetone	OSHA 69		1000		3		50			1		GC-FID	ST	NA SKC					
Acetone (Ketones I)	NIOSH 1300		250		2	0.75	20	50		100 min	15	GC-FID	ST	226-01				38	
Acetone (Ketones I)	NIOSH 2555				0.5 - 3		10-200			varies		GC-FID	ST	NA SKC					
Acetonitrile	EPA TO-17	1689			1 L & 4 L		16.7 ml/min & 66.7 ml/min					TD, GC	ST	226-300 Series	42	TH	224-26-02	51	
Acetonitrile	NIOSH 1606		20		10		20(50)			8(3.3)		GC-FID	ST	226-09				38	
Acetophenone	OSHA PV2003				12		100			2		GC-FID	ST	226-35				38	
Acetyl methyl carbinol (acetoin)	NIOSH 2558				1-10		10-200			varies		GC-FID	ST	NA SKC					
2-Acetylaminofluorene	OSHA CSI				240		1000			4		HPLC-UV	F/CST	225-706	96	C/HLD	225-1	102	
Acetylene tetrabromide	OSHA CSI		1		96		200			8		GC-FID	ST	226-10				38	
Acetylene tetrabromide (1,1,2,2-tetrabromoethane)	NIOSH 2003				96		200			8		GC-FID	ST	226-10				38	
Acetylsalicylic acid	OSHA CSI				120		1000			2		HPLC-UV	F/CST	225-709	96	C/HLD	225-1	102	
Acid black 128	OSHA CSI				200		1000			3.3		HPLC-UV	F/CST	225-706	96	C/HLD	225-1	102	
Acid blue 9	OSHA CSI				100		1000			100 min		HPLC-UV	F/CST	225-706	96	C/HLD	225-1	102	
Acid orange 74	OSHA CSI				200		1000			3.3		HPLC-UV	F/CST	225-706	96	C/HLD	225-1	102	
Acid red 114	OSHA CSI				120		1000			2		HPLC-UV	F/CST	225-709	96	C/HLD	225-1	102	
Acid yellow 34	OSHA CSI				100		1000			100 min		HPLC-UV	F/CST	225-706	96	C/HLD	225-1	102	
Acid yellow 42	OSHA CSI				100		1000			100 min		HPLC-FD	F/CST	225-706	96	C/HLD	225-1	102	
Acremonium species (fungi, molds, spores)	OSHA CSI				120		1000			2		varies	F/CST	225-3-01	90	C/HLD	225-1	102	
Acremonium species (fungi, molds, spores)	OSHA CSI				141.5		28300			5 min		varies	BI	225-9611	120				
Acridine	OSHA 58	1077	0.2 mg/m³		960		2000			8		GR & HPLC	FLT	225-7	96	CST	225-2LF	97	
Acrolein	NIOSH 2501		0.1	0.3	24	3	50	200		8	15	GC-NPD	ST	226-118				40	
Acrolein	OSHA 52		0.1		48	3	100	200		8	15	GC-NPD	ST	226-117				40	

Agency standards for OSHA listings represent the OSHA PELs reported in the 29 CFR 1910.1000 Part 1910, Section 1000.

References and abbreviations are found on pages 212-213.

Chemical Hazard	Agency Reference	Chem F File	SAMPLING ∞								Analytical Method	SKC Collecting Equipment & Page Number					
			Agency Standard		Vol. (liter)		Rate (ml/min)		Time								
			TWA (ppm)	CLG/STEL (ppm)	TWA	CLG/STEL	TWA	CLG/STEL	TWA	CLG/STEL							
				Sample Time or Air Volume	Flow/Sampling Rate	(hrs)	(min)										
Acrolein (Aldehydes, Screening)	NIOSH 2539		0.1	0.3	5		10		8		GC-FID & GC-MS	ST	226-118	40			
Acrylamide	OSHA 21		0.3 mg/m ³		120		1000		2		GC-NPD	ST	226-10	38	FLT	225-16	96
Acrylamide	OSHA PV2004		0.3 mg/m ³		120		1000		2		HPLC-UV	ST	226-57	39			
Acrylic acid	NON 10				48		100		8		GC	ST	226-70A	39			
Acrylic acid	OSHA 28				24		100		4		HPLC-UV	ST	226-30-08	38			
Acrylonitrile	EPA TO-17	1689			1 L & 4 L		16.7 ml/min & 66.7 ml/min				TD, GC	ST	226-300 Series	42	TH	224-26-02	51
Acrylonitrile	NIOSH 1604	1266	1	10 (15 min)	10	3	20(50)	200	8(3.3)	15	GC-FID	ST	226-01	38			
Acrylonitrile	OSHA 37	1265	2	10	20	6	200	400	100 min	15	GC-NPD	ST	226-01	38			
Actinomycetes, thermophilic	NIOSH 0800				varies		28300		varies		varies	BI	225-9611	120			
Adipic acid	OSHA CSI				96		200		8		GC-FID	ST	226-30-16	38			
Adiponitrile	OSHA CSI				10		20(50)		8(3.3)		GC-FID	ST	226-01	38			
Aerobic bacteria (by GC-FAME)	NIOSH 0801				50-300		28300		varies		GC-FID	BI	225-9611	120			
Alcohols (screening)	NIOSH 2549				5		20		4		GC-MS	ST	226-330	42			
Alcohols combined	NIOSH 1405		varies	varies	varies	varies	10-200	10-200	varies	varies	GC-FID	ST	226-01	38			
Alcohols I (see specific compounds)	NIOSH 1400		varies		varies		varies		varies		GC-FID	ST	226-01	38			
Alcohols II (see specific compounds)	NIOSH 1401		varies		varies		varies		8		GC-FID	ST	226-01	38			
Alcohols III (see specific compounds)	NIOSH 1402		varies		varies		varies		8		GC-FID	ST	226-01	38			
Alcohols IV (see specific alcohol)	NIOSH 1403		varies		varies		varies		varies		GC-FID	ST	226-01	38			
Aldehydes	EPA TO-5	1671			< 80 L		100-1000 ml/min				HPLC-UV	IMP	225-36-1	67	IT	225-22	67
Aldehydes (screening)	NIOSH 2539		varies		5		20		4		GC-FID & GC-MS	ST	226-118	40			
Aldehydes (screening)	NIOSH 2549				5		20		4		GC-MS	ST	226-330	42			
Aldicarb (Organonitrogen Pesticides)	NIOSH 5801				240		1000		4		HPLC-UV	ST	226-58	or	ST	226-30-16	38
Aldicarb (Temik)	OSHA 74	1399			480		1000		8		GC-NPD	ST	226-30-16	38			
Aldrin	ASTM D 4861				240-7200		1000-5000		4-24		GC-ECD	PUF	226-92	44			
Aldrin	NIOSH 5502		0.25 mg/m ³		240		500		8		GC-ECN	F/CST	225-709	96	IMP	225-36-2	67
Aldrin	OSHA CSI		0.25 mg/m ³		240		1000		4		GC-ECN	IT	225-22	67	C/HLD	225-1	102
Aldrin	OSHA CSI		0.25 mg/m ³		240		1000		4		GC-ECN	F/CST	225-709	96	IMP	225-36-2	67
Aldrin	OSHA CSI		0.25 mg/m ³		240		1000		4		GC-ECN	IT	225-22	67	C/HLD	225-1	102
Aliphatic hydrocarbons (screening)	NIOSH 2549				5		20		4		GC-MS	ST	226-330	42			
Alkaline dusts	NIOSH 7401					30		2000		15	TITRA	F/CST	225-1715	94	C/HLD	225-1	102
Allethrin	ASTM D 4861				240-7200		1000-5000		4-24		HPLC-UV	PUF	226-92	44			
Allyl alcohol	OSHA CSI		2		10	3	20(50)	200	8(3.3)	15	GC-FID	ST	226-01	38			
Allyl alcohol	OSHA PV2140		2 (skin)		10		50		200 min		GC-FID	ST	226-01	38			
Allyl alcohol (Alcohols Combined)	NIOSH 1405		2	4 (skin)	1-10	1-10	10-200	10-200	varies	varies	GC-FID	ST	226-01	38			
Allyl alcohol (Alcohols III)	NIOSH 1402		2	4	10	3	20(50)	200	8(3.3)	15	GC-FID	ST	226-01	38			
Allyl chloride	NIOSH 1000		1	2		15		1000		15	GC-FID	ST	226-01	38			
Allyl chloride	OSHA 07	1126	1		10	3	20(50)	200	8(3.3)	15	GC-FID	ST	226-01	38			
Allyl glycidyl ether	NIOSH 2545		5	10	6	3	50	200	2	15	GC-FID	ST	226-35-03	39			
Allyl propyl disulfide	OSHA PV2086		2		10		20(50)		8(3.3)		GC-FPD	ST	226-110	40			
Alternaria species (fungi, molds, spores)	OSHA CSI				120		1000		2		varies	F/CST	225-3-01	90	C/HLD	225-1	102
Alternaria species (fungi, molds, spores)	OSHA CSI				141.5		28300		5 min		varies	BI	225-9611	120			
Alumina (aluminum & compounds (total dust as Al))	NIOSH 7013		10 mg/m ³		360		1000		6		AA-F	F/CST	225-3-01	90	C/HLD	225-1	102
Alumina (particulates, respirable)	NIOSH 0600	1038			375		2500		2.5		GR	CYC	225-01-02	111	C/HLD	225-1	102
Alumina (particulates, total)	NIOSH 0500	1035			120		2000		1		GR	FLT	225-5-37-P	93	C/HLD	225-1	102
Alumina (particulates, total)	NIOSH 0500	1035			120		2000		1		GR	CST	225-2LF	97			
alpha-Alumina (respirable fraction)	OSHA CSI		5 mg/m ³		varies		varies		varies		GR	CYC	225-105	110	F/CST	225-803	93
alpha-Alumina (respirable fraction)	OSHA CSI		5 mg/m ³		varies		varies		varies		GR	C/HLD	225-1	102			
alpha-Alumina (total dust)	OSHA CSI		15 mg/m ³		960		2000		8		GR	FLT	225-5-37-P	93	C/HLD	225-1	102
alpha-Alumina (total dust)	OSHA CSI		15 mg/m ³		960		2000		8		GR	CST	225-2LF	97			
Aluminum (Elements by Cellulosic Internal Capsule Sampler)	NIOSH 7306		10 mg/m ³	5 mg/m ³ (total dust)	1-330		1000-4000		Varies		ICP-AES	SC	225-8517	90	C/HLD	225-1	102
Aluminum & compounds (total dust as Al)	NIOSH 7013		10 mg/m ³		360		1000		6		AA-F	F/CST	225-3-01	90	C/HLD	225-1	102
Aluminum (Elements by ICP Aqua Regia Ashing)	NIOSH 7301		10 mg/m ³ (total dust)		5-100		1000-4000		varies		ICP-AES	F/CST	225-3-01	or	F/CST	225-803	93
Aluminum (Elements by ICP Aqua Regia Ashing)	NIOSH 7301		10 mg/m ³ (total dust)		5-100		1000-4000		varies		ICP-AES	F/CST	225-1	102			
Aluminum (Elements by ICP HNO ₃ Digestion)	NIOSH 7303		10 mg/m ³ (total dust)	5 mg/m ³ (respirable fume)	2-10,000		1000-4000		varies		ICP-AES	F/CST	225-3-01	90	C/HLD	225-1	102

Agency standards for OSHA listings represent the OSHA PELs reported in the 29 CFR 1910.1000 Part 1910, Section 1000.

References and abbreviations are found on pages 212-213.

Sampling Guide

www.skinc.com for updates

A	Chemical Hazard	Agency Reference	Chem F File	SAMPLING ∞								Analytical Method	SKC Collecting Equipment & Page Number				
				Agency Standard		Vol. (liter)		Rate (ml/min)		Time							
				TWA (ppm)	CLG/STEL (ppm)	TWA (Sample Time or Air Volume)	CLG/STEL	TWA (Flow/Sampling Rate)	CLG/STEL	TWA (hrs)	CLG/STEL (min)						
Aluminum (Elements by ICP HNO ₃ /HClO ₄ Ashing)	NIOSH 7300	1455	10 mg/m ³ (total dust) 5 mg/m ³ (respirable dust)	5-100		1000-4000		varies			ICP-AES	F/CST	225-3-01	90	C/HLD	225-1	102
Aluminum (respirable fraction)	OSHA CSI		5 mg/m ³	varies		varies		varies			GR	F/CST C/HLD	225-803 225-1	93 102	CYC	225-105	110
Aluminum (total dust)	OSHA CSI		15 mg/m ³	960		2000		8			GR	FLT CST	225-5-37-P 225-2LF	93 97	C/HLD	225-1	102
Aluminum soluble salts	OSHA ID 121			960		2000		8		AA or AES	F/CST	225-3-01	90	C/HLD	225-1	102	
Aluminum welding fumes	OSHA CSI			960		2000		8		GR	FLT CST	225-5-37-P 225-2LF	93 97	C/HLD	225-1	102	
Aluminum, pyro powders	OSHA CSI			960		2000		8		GR	FLT CST	225-5-37-P 225-2LF	93 97	C/HLD	225-1	102	
Alupent	OSHA CSI			720		2000		6		HPLC-UV	F/CST	225-709	96	C/HLD	225-1	102	
Amiben	OSHA CSI			240		1000		4		HPLC-UV	F/CST	225-709	96	C/HLD	225-1	102	
Amines	NIOSH 2002		varies	20		40		8		GC-FID or GC-NSD	ST	226-10	38				
Amines, aliphatic	NIOSH 2010		varies	24		50		8		GC-FID	ST	226-10	38				
2-Amino-2-methyl-1-propanol	OSHA CSI			9		100		90 min		GC-NPD	ST	226-10	38				
2-Amino-2-methyl-1-propanol	OSHA PV2145			10		100		100 min		HPLC-UV	ST	226-30-16	38				
4-Aminobiphenyl	OSHA 93	1233		100		1000		100 min		GC-ECD	CF/CST	225-9004	64	C/HLD	225-1	102	
2-Aminoethanol	NIOSH 2007		3 6	10		20		8		GC-FID	ST	226-10-04	38				
2-Aminoethanol	NIOSH 3509		3 6	240		1000		4		IC	IMP	225-36-1	67	IT	225-22	67	
2-Aminoethanol	OSHA PV2111		3	10	1.5	100	100	100 min	15	HPLC-UV	ST	226-30-18	38				
Aminoethanol compounds I (see specific compounds)	NIOSH 2007		varies	varies		varies		8		GC-FID	ST	226-10-04	38				
Aminoethanol compounds II (see specific compounds)	NIOSH 3509		varies	240		1000		4		IC	IMP	225-36-1	67	IT	225-22	67	
Aminoethylethanolamine	OSHA PV2116			10		100				HPLC-UV	ST	226-30-18	38				
N-Aminoethylpiperazine	OSHA CSI			9		100		90 min		GC-NPD	ST	226-98	40				
p-Aminophenylarsonic acid (arsenic, organo-)	NIOSH 5022			960		2000		8		IC-AA	FLT C/HLD	225-17-01 225-1	94 102	CST	225-3LF	97	
2-Aminopyridine	OSHA CSI		0.5	12		200		1		GC-FID	ST	226-35-02	38				
2-Aminopyridine	OSHA PV2143		0.5	240		1000		4		GC-NPD	CF/CST	225-9004	64	C/HLD	225-1	102	
3-Aminopyridine	OSHA PV2143			240		1000		4		GC-NPD	CF/CST	225-9004	64	C/HLD	225-1	102	
4-Aminopyridine	OSHA PV2143			240		1000		4		GC-NPD	CF/CST	225-9004	64	C/HLD	225-1	102	
Amitrole	OSHA PV2006			60		1000		1		HPLC-UV	IMP	225-36-1	67	IT	225-22	67	
Ammonia	NIOSH 6015		25 35	72 3		150 200		8 15		VAS	ST	226-10-06	38	F/CST	225-3-01**	90	
Ammonia	NON 41			18 5		75 500		4 10		CLR	ST	226-61	39				
Ammonia	OSHA ID 188	1008	50	24 7.5		100 500		4 15		IC-CD	ST	226-29	38				
Ammonia (by IC)	NIOSH 6016		25 35	48 3		100 200		8 15		IC	ST	226-10-06	38	F/CST	225-3-01	90	
Ammonium chloride (fume)	OSHA ID 188			960 30		2000 2000		8 15		IC-CD	F/CST	225-3-01	90	C/HLD	225-1	102	
Ammonium hydroxide (see ammonia)																	
Ammonium metavanadate (see vanadium oxides)	NIOSH 7504																
Ammonium nitrate	OSHA CSI			960		2000		8		GR	FLT CST	225-5-37-P 225-2LF	93 97	C/HLD	225-1	102	
Ammonium sulfamate (respirable dust)	OSHA CSI		5 mg/m ³	varies		varies		varies		GR	CYC F/CST	225-105 225-803	110 93	C/HLD	225-1	102	
Ammonium sulfamate (total dust)	OSHA CSI		15 mg/m ³	960		2000		8		GR	FLT CST	225-5-37-P 225-2LF	93 97	C/HLD	225-1	102	
Ammonium sulfamate (total dust)	OSHA ID 188		15 mg/m ³	960		2000		8		GR & IC-ECN	F/CST	225-3-01	90	C/HLD	225-1	102	
n-Amyl acetate	OSHA 07		100	10		20(50)		8(3.3)		GC-FID	ST	226-01	38				
sec-Amyl acetate (2-pentyl acetate)	OSHA 07		125	10		20(50)		8(3.3)		GC-FID	ST	226-01	38				
n-Amyl acetate (Esters I)	NIOSH 1450		100	1-10		10-200		varies		GC-FID	ST	226-01	38				
Amyl nitrite	OSHA CSI			8		50		2.5		HPLC-UV	ST	226-01	38				
Aniline	NIOSH 2017		LFC	24		200		2		GC-FID	CF/CST	225-9004	64	ST	226-15	38	
Aniline	OSHA PV2079		5	24		50		8		GC-FID	ST	226-98	40				
Aniline (Amines, Aromatic)	NIOSH 2002	1058	LFC	24		50		8		GC-FID or GC-NSD	ST	226-10	38				
o-Anisaldehyde	OSHA CSI			96		200		8		HPLC-UV	ST	226-30	38				
Anisidine	NIOSH 2514		0.5 mg/m ³	240		1000		4		HPLC-UV	ST	226-30-05	38				
Anisidine (o- & p-isomers)	OSHA CSI		0.5 mg/m ³	240		1000		4		HPLC-UV	ST	226-30-05	38				
Anthophyllite fibers (see asbestos fibers)	NIOSH 7400																
Anthracene	OSHA 58	1075	0.2 mg/m ³	960		2000		8		GR & HPLC-FD, or GR & HPLC-UV	FLT C/HLD	225-7 225-1	96 102	CST	225-2LF	97	

Agency standards for OSHA listings represent the OSHA PELs reported in the 29 CFR 1910.1000 Part 1910, Section 1000.

References and abbreviations are found on pages 212-213.

Chemical Hazard	Agency Reference	Chem F File	SAMPLING ∞								Analytical Method	SKC Collecting Equipment & Page Number									
			Agency Standard		Vol. (liter)		Rate (ml/min)		Time												
			TWA (ppm)	CLG/STEL (ppm)	TWA (Sample Time or Air Volume)	CLG/STEL	TWA (Flow/Sampling Rate)	CLG/STEL	TWA (hrs)	CLG/STEL (min)											
Anthracene (Polynuclear Aromatic Hydrocarbons by GC-MS)	ASTM D 6209				350 m ³ (max)			225 L/min			1-24	GC-MS	PUF	226-131	45	FLT	225-1808	95			
Anthracene (Polynuclear Aromatic Hydrocarbons by GC)	NIOSH 5515				480			2000			4	GC-FID	F/CST	225-1713	94	ST	226-30-04	38			
Anthracene (Polynuclear Aromatic Hydrocarbons by HPLC)	NIOSH 5506				480			2000			4	HPLC-UV	F/CST	225-1713	94	ST	226-30-04	38			
Antimony & compounds (as Sb)	OSHA ID 121				0.5 mg/m ³			960			2000	8	AA or AES	F/CST	225-3-01	90	C/HLD	225-1	102		
Antimony & compounds (as Sb)	OSHA ID 125G				0.5 mg/m ³			480			2000	4	ICP-AES	F/CST	225-3-01	or	F/CST	225-3100	or		
Antimony (Elements by Cellulosic Internal Capsule Sampler)	NIOSH 7306				0.05 mg/m ³			1-2000			1000-4000	Varies	ICP-AES	SC	225-8517	90	C/HLD	225-1	102		
Antimony (Elements by ICP Aqua Regia Ashing)	NIOSH 7301				0.5 mg/m ³			50-2000			1000-4000	varies	ICP-AES	F/CST	225-3-01	or	F/CST	225-803	93		
Antimony (Elements by ICP HNO ₃ Digestion)	NIOSH 7303				0.5 mg/m ³			3-100,000			1000-4000	varies	ICP-AES	F/CST	225-3-01	90	C/HLD	225-1	102		
Antimony (Elements by ICP HNO ₃ /HClO ₄ Ashing)	NIOSH 7300	1455			0.5 mg/m ³			50-2000			1000-4000	varies	ICP-AES	F/CST	225-3-01	90	C/HLD	225-1	102		
Antimony (ICP Analysis of Metal/metalloid Particulates from Solder Operations)	OSHA ID 206				0.5 mg/m ³			480			2000	4	ICP-AES	F/CST	225-3-01	90	C/HLD	225-1	102		
ANTU (alphanaphthyl thiourea)	OSHA CSI				0.3 mg/m ³			480			2000	4	HPLC-UV	FLT	225-17-01	94	CST	225-2LF	97		
Apron	OSHA PV2102				60			1000			1	HPLC-UV	F/CST	225-709	96	C/HLD	225-1	102			
Aroclor	ASTM D 4861				240-7200			1000-5000			4-24	GC-ECD	PUF	226-92	44						
Aroclor	NIOSH 5602				480			1000			8	GC-ECD	ST	226-58	39						
Aroclor 1242	ASTM D 4861				240-7200			1000-5000			4-24	GC-ECD	PUF	226-92	44						
Aroclor 1242 (42% Cl) (see polychlorobiphenyls)	NIOSH 5503																				
Aroclor 1254	ASTM D 4861				240-7200			1000-5000			4-24	GC-ECD	PUF	226-92	44						
Aroclor 1254 (54% Cl) (see polychlorobiphenyls)	NIOSH 5503																				
Aroclor 1260	ASTM D 4861				240-7200			1000-5000			4-24	GC-ECD	PUF	226-92	44						
Aromatic hydrocarbons (screening)	NIOSH 2549				5			20			4	GC-MS	ST	226-330	42						
Arsenic (Elements by Cellulosic Internal Capsule Sampler)	NIOSH 7306				0.002 mg/m ³			32-2000			1000-4000	Varies	ICP-AES	SC	225-8517	90	C/HLD	225-1	102		
Arsenic & compounds (as As)	NIOSH 7900				2 µg/m ³ (15 min)			30			2000	15	AA-F	F/CST	225-3-01	90	C/HLD	225-1	102		
Arsenic (Elements by ICP Aqua Regia Ashing)	NIOSH 7301				0.002 mg/m ³			5-2000			1000-4000	varies	ICP-AES	F/CST	225-3-01	or	F/CST	225-803	93		
Arsenic (Elements by ICP HNO ₃ Digestion)	NIOSH 7303				0.002 mg/m ³			8-5,000,000			1000-4000	varies	ICP-AES	F/CST	225-3-01	90	C/HLD	225-1	102		
Arsenic (Elements by ICP HNO ₃ /HClO ₄ Ashing)	NIOSH 7300	1040			0.002 mg/m ³ (C)			5-2000			1000-4000	varies	ICP-AES	F/CST	225-3-01	90	C/HLD	225-1	102		
Arsenic (Elements on Wipes)	NIOSH 9102				wipe								ICP-AES	W	225-2414	140	TMP	225-2403	or		
Arsenic (inorganic compounds as As)	OSHA ID 105				0.01 mg/m ³			960			2000	8	AAS-HGA	F/CST	225-3-01	90	C/HLD	225-1	102		
Arsenic trioxide as AS	NIOSH 7901				2 mg/m ³ (15 min)			30			2000	15	AAS-GF	FLT	225-5 ‡	88	CST	225-2LF	97		
Arsenic, inorganic (volatile compounds as As)	OSHA ID 105				0.01 mg/m ³			960			2000	8	AAS-HGA	CF/CST	225-9001	64	C/HLD	225-1	102		
Arsenic, organo-	NIOSH 5022				960			2000			8	IC-AA	FLT	225-17-01	94	CST	225-2LF	97			
Arsine	NIOSH 6001	1278			2 µg/m ³ (15 min)			10	3		20	200	8	15	AAS-GF	ST	226-01	38			
Arylam (see carbaryl)																					
Asbestos	OSHA ID 160	1301			0.1 fbr/cc	1 fbr/cc	EL	25-1200	25-1200		500-2500	500-2500	varies	varies	PCM	FLT/CL	225-321	or	FLT/CL	225-326	or
Asbestos ((bulk) by PLM)	NIOSH 9002				1% (bulk)			bulk							PLM						
Asbestos (by TEM)	NIOSH 7402				0.1 fbr/cc/400L			960			2000	8	TEM	FLT/CL	225-327	90					
Asbestos (chrysotile)	NIOSH 9000				bulk										XRD						
Asbestos (mass concentrations)	ASTM D 5756	1440			varies			2000			2 min (minimum)	TEM	MVC	225-322	142						
Asbestos (structure number concentrations)	ASTM D 5755	1440			varies			2000			2 min (minimum)	TEM	MVC	225-322	142						
Asbestos fibers	NIOSH 7400	1033			0.1 fbr/cc/400L			varies			varies	varies	PCM	FLT/CL	225-321	or	FLT/CL	225-326	or		
Aspartame	NIOSH 5031				480			1000			1000	8	HPLC-UV	FLT	225-17-01	94	CST	225-2LF	97		
Aspergillus flavipes species (fungi, molds, spores)	OSHA CSI				120			1000			1000	2	varies	F/CST	225-3-01	90	C/HLD	225-1	102		
Aspergillus flavipes species (fungi, molds, spores)	OSHA CSI				141.5			28300			28300	5 min	varies	BI	225-9611	120					
Aspergillus flavus species (fungi, molds, spores)	OSHA CSI				120			1000			1000	2	varies	F/CST	225-3-01	90	C/HLD	225-1	102		
Aspergillus flavus species (fungi, molds, spores)	OSHA CSI				141.5			28300			28300	5 min	varies	BI	225-9611	120					
Aspergillus fumigatus species (fungi, molds, spores)	OSHA CSI				120			1000			1000	2	varies	F/CST	225-3-01	90	C/HLD	225-1	102		
Aspergillus fumigatus species (fungi, molds, spores)	OSHA CSI				141.5			28300			28300	5 min	varies	BI	225-9611	120					

Agency standards for OSHA listings represent the OSHA PELs reported in the 29 CFR 1910.1000 Part 1910, Section 1000.

References and abbreviations are found on pages 212-213.

Sampling Guide

www.skinc.com for updates

A	Chemical Hazard	Agency Reference	Chem F File	SAMPLING ∞								Analytical Method	SKC Collecting Equipment & Page Number					
				Agency Standard		Vol. (liter)		Rate (ml/min)		Time								
				TWA (ppm)	CLG/STEL (ppm)	TWA (Sample Time or Air Volume)	CLG/STEL	TWA (Flow/Sampling Rate)	CLG/STEL	TWA (hrs)	CLG/STEL (min)							
Aspergillus glaucus species (fungi, molds, spores)	OSHA CSI				120		1000		2		varies	F/CST	225-3-01	90	C/HLD	225-1	102	
Aspergillus glaucus species (fungi, molds, spores)	OSHA CSI				141.5		28300		5 min		varies	BI	225-9611	120				
Aspergillus nidulans species (fungi, molds, spores)	OSHA CSI				120		1000		2		varies	F/CST	225-3-01	90	C/HLD	225-1	102	
Aspergillus nidulans species (fungi, molds, spores)	OSHA CSI				141.5		28300		5 min		varies	BI	225-9611	120				
Aspergillus niger species (fungi, molds, spores)	OSHA CSI				120		1000		2		varies	F/CST	225-3-01	90	C/HLD	225-1	102	
Aspergillus niger species (fungi, molds, spores)	OSHA CSI				141.5		28300		5 min		varies	BI	225-9611	120				
Aspergillus ochraceus (fungi, molds, spores)	OSHA CSI				120		1000		2		varies	F/CST	225-3-01	90	C/HLD	225-1	102	
Aspergillus ochraceus (fungi, molds, spores)	OSHA CSI				141.5		28300		5 min		varies	BI	225-9611	120				
Aspergillus versicolor (fungi, molds, spores)	OSHA CSI				120		1000		2		varies	F/CST	225-3-01	90	C/HLD	225-1	102	
Aspergillus versicolor (fungi, molds, spores)	OSHA CSI				141.5		28300		5 min		varies	BI	225-9611	120				
Asphalt fume (benzene-soluble & total particulate)	NIOSH 5042			5 mg/m ³ (15 min) (C)	360	60	1000	4000	6	15	GR	FLT CST	225-27-07 225-2LF	94 97	SP	225-27	103	
Asphalt fume particulate	ASTM D 6494				960		2000		8		GR	F/CST	225-1713	94	C/HLD	225-1	102	
Asphalt fumes (petroleum)	OSHA 58	1078			960		2000		8		GR & HPLC- FD, or GR & HPLC-UV	FLT C/HLD	225-7 225-1	96	CST	225-2LF	97	
Atrazine	ASTM D 4861				240-7200		1000-5000		4-24		GC-NPD	PUF	226-92	44				
Atrazine	NIOSH 5602	5			480		1000		8		GC-ECD	ST	226-58	39				
Atrazine	OSHA CSI				240		1000		4		HPLC-UV	F/CST	225-706	96	C/HLD	225-1	102	
Auramine	OSHA CSI				100		1000		100 min		HPLC-UV	F/CST	225-709	96	C/HLD	225-1	102	
Aureobasidium pullulans (fungi, molds, spores)	OSHA CSI				120		1000		2		varies	F/CST	225-3-01	90	C/HLD	225-1	102	
Aureobasidium pullulans (fungi, molds, spores)	OSHA CSI				141.5		28300		5 min		varies	BI	225-9611	120				
Aureobasidium species (fungi, molds, spores)	OSHA CSI				120		1000		2		varies	F/CST	225-3-01	90	C/HLD	225-1	102	
Aureobasidium species (fungi, molds, spores)	OSHA CSI				141.5		28300		5 min		varies	BI	225-9611	120				
Azelaic acid	NIOSH 5019				960		2000		8		GC-FID	F/CST	225-803	93	C/HLD	225-1	102	
Azinphos-ethyl	OSHA CSI				480		1000		8		GC-FPD	ST	226-30-16	38				
Azinphos-methyl	OSHA PV2087		0.2 mg/m ³		480		1000		8		GC-FPD	ST	226-30-16	38				
Azinphos-methyl (Organophosphorus Pesticides)	NIOSH 5600		0.2 mg/m ³		240		1000		4		GC-FPD	ST	226-58	39				
1,1'-Azobisformamide	OSHA CSI				90		1000		1.5		HPLC-UV	ST	226-30-16	38				
Bacteria	NIOSH 0800				varies		28300		varies		varies	BI	225-9611	120				
Bacteria (by GC-FAME)	NIOSH 0801				50-300		28300		varies		GC-FID	BI	225-9611	120				
Bacteria (in air)	NON 48				62.5-375		12500 +		5-30		varies	BS	225-9595	122	VT	225-9598A	122	
Barium (Elements by Cellulosic Internal Capsule Sampler)	NIOSH 7306				3-2000		1000-4000		Varies		ICP-AES	SC	225-8517	90	C/HLD	225-1	102	
Barium (Elements by ICP Aqua Regia Ashing)	NIOSH 7301		0.5 mg/m ³		50-2000		1000-4000		varies		ICP-AES	F/CST C/HLD	225-3-01 225-1	or	F/CST	225-803	93	
Barium (Elements by ICP HNO ₃ Digestion)	NIOSH 7303				1-100,000		1000-4000		varies		ICP-AES	F/CST	225-3-01	90	C/HLD	225-1	102	
Barium (Elements on Wipes)	NIOSH 9102				wipe						ICP-AES	W TMP	225-2414 225-2415	140 140	TMP	225-2403	or	
Barium (insoluble compounds)	OSHA ID 121				960		2000		8		AA or AES	F/CST	225-3-01	90	C/HLD	225-1	102	
Barium (soluble compounds)	NIOSH 7056		0.5 mg/m ³		960		2000		8		AA	F/CST	225-3-01	90	C/HLD	225-1	102	
Barium (soluble compounds)	OSHA ID 121		0.5 mg/m ³		960		2000		8		AA or AES	F/CST	225-3-01	90	C/HLD	225-1	102	
Barium chloride (barium, soluble compounds)	NIOSH 7056		0.5 mg/m ³		960		2000		8		AA	F/CST	225-3-01	90	C/HLD	225-1	102	
Barium sulfate (respirable fraction)	OSHA ID 204	1216	5 mg/m ³		varies		varies		varies		GR & XRF	CYC F/CST	225-105 225-3-01	110 90	C/HLD	225-1	102	
Barium sulfate (total dust)	OSHA ID 121	1217	15 mg/m ³		960		2000		8		AA or AES	F/CST	225-802	93	C/HLD	225-1	102	
Baygon (propoxur)	ASTM D 4861				240-7200		1000-5000		4-24		HPLC-UV	PUF	226-92	44				
Baygon (propoxur)	OSHA PV2007				48		100		8		HPLC-UV	ST	226-30-16	38				
Bendiocarb	ASTM D 4861				240-7200		1000-5000		4-24		HPLC-UV	PUF	226-92	44				
Bendiocarb (Ficam)	OSHA PV2008				240		1000		4		HPLC-UV	ST	226-30-16	38				
Benomyl (Organonitrogen Pesticides)	NIOSH 5601				240		1000		4		HPLC-UV	ST	226-58	or	ST	226-30-16	38	
Benomyl (respirable dust)	OSHA CSI		5 mg/m ³		varies		varies		varies		HPLC-UV	ST	226-30-16	38	CYC	225-105	110	
Benomyl (total dust)	OSHA PV2107		15 mg/m ³		60		1000		1		HPLC-UV	ST	226-30-16	38				
Bentonite (see dust, total and respirable nuisance)																		
Benz(a)anthracene	OSHA CSI				960		2000		8		HPLC-UV	F/CST	225-709	96	C/HLD	225-1	102	
Benz(a)anthracene (Polynuclear Aromatic Hydrocarbons by GC-MS)	ASTM D 6209				350 m ³ (max)		225 L/min		1-24		GC-MS	PUF	226-131	45	FLT	225-1808	95	
Benz(a)anthracene (Polynuclear Aromatic Hydrocarbons by GC)	NIOSH 5515				480		2000		4		GC-FID	F/CST C/HLD	225-1713 225-1	94 102	ST	226-30-04	38	
Benz(a)anthracene (Polynuclear Aromatic Hydrocarbons by HPLC)	NIOSH 5506				480		2000		4		HPLC-FD	F/CST C/HLD	225-1713 225-1	94 102	ST	226-30-04	38	
Benzaldehyde	ASTM D 5197				varies		500-1200		5 min-24 hrs		HPLC-UV	ST	226-120 ^o	or	ST	226-119	40	
Benzene	ASTM D 5466				6		varies		varies		GC-MS	CAN	228 Series		PK	228 Series		

Agency standards for OSHA listings represent the OSHA PELs reported in the 29 CFR 1910.1000 Part 1910, Section 1000.

References and abbreviations are found on pages 212-213.

Chemical Hazard	Agency Reference	Chem F File	SAMPLING ∞								Analytical Method	SKC Collecting Equipment & Page Number				
			Agency Standard		Vol. (liter)		Rate (ml/min)		Time							
			TWA (ppm)	CLG/STEL (ppm)	TWA (Sample Time or Air Volume)	CLG/STEL	TWA (Flow/Sampling Rate)	CLG/STEL	TWA (hrs)	CLG/STEL (min)						
Benzene	EPA TO-17	1689			1 L & 4 L		16.7 ml/min & 66.7 ml/min				TD, GC	ST CPC	226-300 Series	42 TH	224-26-02	51
Benzene	OSHA 1005	1749	1	5	12	0.75	50	50	4	15	GC-FID	ST	226-01	38		
Benzene	OSHA 1005	1749	1	5					8	15	GC-FID	PS	575-002	75		
Benzene	OSHA 12	1009	1	5	10	3	200	200	50 min	15	GC-FID	ST	226-01	38		
Benzene (by portable GC)	NIOSH 3700	1029	0.1	1 (15 min)	varies		20-5000		varies		P GC-PID	SB	232 Series	55		
Benzene (Hydrocarbons, Aromatic)	NIOSH 1501		0.1	1	5-30	5-30	10-200	10-200	varies	varies	GC-FID	ST	226-01	38		
alpha-Benzene hexachloride	ASTM D 4861				240-7200		1000-5000		4-24		GC-ECD	PUF	226-92	44		
beta-Benzene hexachloride	ASTM D 4861				240-7200		1000-5000		4-24		GC-ECD	PUF	226-92	44		
gamma-Benzene hexachloride	ASTM D 4861				240-7200		1000-5000		4-24		GC-ECD	PUF	226-92	44		
1,2-Benzenedicarboxylic acid	OSHA CSI				240		1000		4		GC-FID	ST	226-56	39		
Benzene-soluble & total particulate (asphalt fume)	NIOSH 5042			5 mg/m ³ (15 min) (C)	360	60	1000	4000	6	15	GR	FLT CST	225-27-07	94 SP	225-27	103
Benzene-soluble particulate matter	ASTM D 4600	1416			960		2000		8		GR	FLT CST	225-7	96 SP	225-27	103
Benzidine	NIOSH 5509		LFC		96		200		8		HPLC-UV	FLT	225-16	96 CST	225-32	102
Benzidine	OSHA 65	1239			100		1000		100 min		GC-ECD	CF/CST	225-9004	64 C/HLD	225-1	102
Benzidine dyes (dyes, benzidine)	NIOSH 5013		LFC		480		1000		8		HPLC	FLT C/HLD	225-17A	94 CST	225-3LF	97
Benzidine-based dyes	OSHA CSI				480		1000		8		HPLC-UV	FLT C/HLD	225-17-04	94 CST	225-3LF	97
Benzo(a)pyrene (Polynuclear Aromatic Hydrocarbons by GC)	NIOSH 5515		0.1 mg/m ³		480		2000		4		GC-FID	F/CST C/HLD	225-1713	94 ST	226-30-04	38
Benzo(a)pyrene (Polynuclear Aromatic Hydrocarbons by GC-MS)	ASTM D 6209			350 m ³ (max)			225 L/min		1-24		GC-MS	PUF PEM	226-131	45 FLT	225-1808	95
Benzo(a)pyrene (Polynuclear Aromatic Hydrocarbons by HPLC)	NIOSH 5506				480		2000		4		HPLC-FD	F/CST C/HLD	225-1713	94 ST	226-30-04	38
Benzo(b)fluoranthene (Polynuclear Aromatic Hydrocarbons by GC-MS)	ASTM D 6209			350 m ³ (max)			225 L/min		1-24		GC-MS	PUF PEM	226-131	45 FLT	225-1808	95
Benzo(b)fluoranthene (Polynuclear Aromatic Hydrocarbons by GC)	NIOSH 5515				480		2000		4		GC-FID	F/CST C/HLD	225-1713	94 ST	226-30-04	38
Benzo(b)fluoranthene (Polynuclear Aromatic Hydrocarbons by HPLC)	NIOSH 5506				480		2000		4		HPLC-FD	F/CST C/HLD	225-1713	94 ST	226-30-04	38
Benzo(e)pyrene	OSHA CSI				960		2000		8		HPLC-UV	F/CST	225-706	96 C/HLD	225-1	102
Benzo(e)pyrene (Polynuclear Aromatic Hydrocarbons by GC)	NIOSH 5515				480		2000		4		GC-FID	F/CST C/HLD	225-1713	94 ST	226-30-04	38
Benzo(e)pyrene (Polynuclear Aromatic Hydrocarbons by GC-MS)	ASTM D 6209			350 m ³ (max)			225 L/min		1-24		GC-MS	PUF	226-131	45 FLT	225-1808	95
Benzo(e)pyrene (Polynuclear Aromatic Hydrocarbons by HPLC)	NIOSH 5506				480		2000		4		HPLC-FD	F/CST C/HLD	225-1713	94 ST	226-30-04	38
Benzo(g,h,i)perylene (Polynuclear Aromatic Hydrocarbons by GC-MS)	ASTM D 6209			350 m ³ (max)			225 L/min		1-24		GC-MS	PUF	226-131	45 FLT	225-1808	95
Benzo(g,h,i)perylene (Polynuclear Aromatic Hydrocarbons by GC)	NIOSH 5515				480		2000		4		GC-FID	F/CST C/HLD	225-1713	94 ST	226-30-04	38
Benzo(g,h,i)perylene (Polynuclear Aromatic Hydrocarbons by HPLC)	NIOSH 5506				480		2000		4		HPLC-FD	F/CST C/HLD	225-1713	94 ST	226-30-04	38
Benzo(k)fluoranthene (Polynuclear Aromatic Hydrocarbons by GC)	NIOSH 5515				480		2000		4		GC-FID	F/CST C/HLD	225-1713	94 ST	226-30-04	38
Benzo(k)fluoranthene (Polynuclear Aromatic Hydrocarbons by HPLC)	NIOSH 5506				480		2000		4		HPLC-FD	F/CST C/HLD	225-1713	94 ST	226-30-04	38
Benzo(a)anthracene	OSHA 58		0.2 mg/m ³		960		2000		8		GR & HPLC-FD, or GR & HPLC-UV	FLT C/HLD	225-7	96 CST	225-2LF	97
2,3-Benzofuran	OSHA CSI				96		200		8		HPLC-UV	ST	226-30	38		
Benzoic acid	OSHA CSI				24		100		4		GC-FID	ST	226-115	40		
Benzophenone	NON 39				480		1000		8		GC-FID	ST	226-56	39		
Benzophenone	OSHA PV2130		0.5 mg/m ³		48		200		4		GC-FID	ST	226-110	40		
Benzophenonetetracarboxylic acid dianhydride	OSHA CSI				100		1000		100 min		HPLC	FLT C/HLD	225-17-04	94 CST	225-2LF	97
Benzothiazole in asphalt fume	NIOSH 2550				480		1000		8		GC-SCD	F/CST C/HLD	225-1713	94 ST	226-30-04	38
2-Benzothiazolethiol	OSHA CSI				240		2000		2		HPLC-UV	F/CST	225-706	96 C/HLD	225-1	102
Benzo(a)trichloride	OSHA ID 216SG				12		200		1		GC-FID	ST	226-35-03	39		
Benzoyl chloride	OSHA CSI				90		1000		1.5		GC-ECD	IMP	225-36-1	67 IT	225-22	67
Benzoyl peroxide	NIOSH 5009		5 mg/m ³		90		1500		1		HPLC-UV	F/CST	225-3-01	90 C/HLD	225-1	102
Benzyl acetate	OSHA PV2124				10		100		100 min		GC-FID	ST	226-73	39		

B

Agency standards for OSHA listings represent the OSHA PELs reported in the 29 CFR 1910.1000 Part 1910, Section 1000.

References and abbreviations are found on pages 212-213.

Sampling Guide

www.skinc.com for updates

B

Chemical Hazard	Agency Reference	Chem F File	SAMPLING ∞								Analytical Method	SKC Collecting Equipment & Page Number			
			Agency Standard		Vol. (liter)		Rate (ml/min)		Time						
			TWA (ppm)	CLG/STEL (ppm)	TWA (Sample Time or Air Volume)	CLG/STEL	TWA (Flow/Sampling Rate)	CLG/STEL	TWA (hrs)	CLG/STEL (min)					
Benzyl alcohol	OSHA PV2009			24		100		4		GC-FID	ST 226-95	40			
Benzyl chloride	ASTM D 5466			6		varies		varies		GC-MS	CAN 228 Series	PK 228 Series			
Benzyl chloride	OSHA 07	1187	1	10		20(50)		8(3.3)		GC-FID	ST 226-01	38			
Benzyl chloride (hydrocarbons, halogenated)	NIOSH 1003			1	10		10-200		varies	GC-FID	ST 226-01	38			
Beryllium & compounds	OSHA ID 125G			2 µg/m³	5 µg/m³	480	60	2000	2000	4	15	ICP-AES	F/CST 225-3-01 F/CST 225-803 C/HLD 225-1	or F/CST 225-3100 or F/CST 225-8215	or 93
Beryllium & compounds (as Be)	NIOSH 7102			0.5 µg/m³	960			2000		8		AA-GF	F/CST 225-3-01	90 C/HLD 225-1	102
Beryllium (Elements by Cellulosic Internal Capsule Sampler)	NIOSH 7306			0.0005 mg/m³	0.005 mg/m³	10-2000		1000-4000		Varies		ICP-AES	SC 225-8517	90 C/HLD 225-1	102
Beryllium (Elements by ICP Aqua Regia Ashing)	NIOSH 7301			0.0005 mg/m³		1250-2000		1000-4000		varies		ICP-AES	F/CST 225-3-01 C/HLD 225-1	or 102	F/CST 225-803 ¥ 93
Beryllium (Elements by ICP HNO ₃ Digestion)	NIOSH 7303					35-25,000,000		1000-4000		varies		ICP-AES	F/CST 225-3-01	90 C/HLD 225-1	102
Beryllium (Elements by ICP HNO ₃ /HClO ₄ , Ashing)	NIOSH 7300	1455		0.0005 mg/m³		1250-2000		1000-4000		varies		ICP-AES	F/CST 225-3-01	90 C/HLD 225-1	102
Beryllium (Elements on Wipes)	NIOSH 9102				wipe							ICP-AES	W 225-2414 TMP 225-2415	140 TMP 225-2403	or 140
Beryllium (ICP analysis of metal/metalloid particulates from solder operations)	OSHA ID 206			2 mg/m³	5 mg/m³ (C)	480	10	2000	2000	4	5	ICP-AES	F/CST 225-3-01	90 C/HLD 225-1	102
Beryllium (in air by portable fluorometry)	NIOSH 7704			2 mg/m³	5 mg/m³ (C)	240-2000		1000-4000				P FLUOR UV/VIS	F/CST 225-3-01 C/HLD 225-1	or 102	F/CST 225-3100 90
Betasan	OSHA CSI				480			1000		8		GC-FPD	ST 226-30-16	38	
BHC (alpha-, beta-, gamma-)	ASTM D 4861				240-7200			1000-5000		4-24		GC-ECD	PUF 226-92	44	
Bioaerosol sampling	NIOSH 0800				varies			28300		varies		BI	225-9611	120	
Bioaerosols					15-150			15000		1-10 min		varies	STC 225-9820	101	
Bioaerosols	NON 48				62.5-375			12500 +		5-30		varies	BS 225-9595	122 VT 225-9598A	122
Biphenyl (diphenyl)	NIOSH 2530		0.2	10		20(50)		1000		8(3.3)		GC-FID	ST 226-35-01	38	
Bipolaris species (fungi, molds, spores)	OSHA CSI				120			1000		2		varies	F/CST 225-3-01	90 C/HLD 225-1	102
Bipolaris species (fungi, molds, spores)	OSHA CSI				141.5			28300		5 min		varies	BI 225-9611	120	
4,4'-Bipyridine (vapor & aerosol)	NON 26			96	2	200	200	200	200	8	10	HPLC	ST 226-30-05 C/HLD 225-1	38 F/CST 225-706	96
Bis (tributyltin) oxide (tin, organic compounds [as Sn])	OSHA CSI				960			2000		8		AA-GF	F/CST 225-709	96 C/HLD 225-1	102
Bismuth	OSHA CSI				960			2000		8		AA	F/CST 225-3-01	90 C/HLD 225-1	102
Bismuth (Elements by ICP HNO ₃ Digestion)	NIOSH 7303				1-10,000			1000-4000		varies		ICP-AES	F/CST 225-3-01	90 C/HLD 225-1	102
Bismuth telluride, Se-doped	OSHA ID 121			5 mg/m³	960			2000		8		AA or AES	FLT 225-5-37-P CST 225-2LF	93 C/HLD 225-1	102
Bismuth telluride, undoped (respirable dust)	OSHA ID 121			5 mg/m³	varies			varies		varies		GR & AA or GR & AES	CYC 225-105 F/CST 225-803	110 C/HLD 225-1	93
Bismuth telluride, undoped (total dust)	OSHA CSI			15 mg/m³	960			2000		8		GR	FLT 225-5-37-P CST 225-2LF	93 C/HLD 225-1	97
Bisphenol A	OSHA 1018			240		1000		240 (min)				HPLC-UV/PDA	F/CST 225-709	96 C/HLD 225-1	102
Bladex	OSHA CSI			100		1000		1000		100 min		HPLC-UV	IMP 225-36-1	67 IT 225-22	67
Borates tetrasodium salts (anhydrous, decahydrate & pentahydrate)	OSHA ID 125G			480		2000		2000		4		ICP-AES	F/CST 225-3-01 F/CST 225-803 C/HLD 225-1	or F/CST 225-3100 or F/CST 225-8215	or 93
Boric acid (total dust)	OSHA CSI			960		2000		2000		8		GR	FLT 225-5-37-P CST 225-2LF	93 C/HLD 225-1	97
Boron (Elements by ICP HNO ₃ Digestion)	NIOSH 7303				1-3300			1000-4000		varies		ICP-AES	F/CST 225-3-01	90 C/HLD 225-1	102
Boron (total dust)	OSHA CSI			960		2000		2000		8		GR	FLT 225-5-37-P CST 225-2LF	93 C/HLD 225-1	97
Boron carbide	NIOSH 7506			600		2500		2500		4		XRD	F/CST 225-803 CYC 225-01-02	93 C/HLD 225-1	111
Boron oxide (particulates, respirable)	NIOSH 0600	1038		375		2500		2500		2.5		GR	FLT 225-5-37-P CYC 225-01-02	93 C/HLD 225-1	111 CST 225-3LF 97
Boron oxide (particulates, total)	NIOSH 0500	1035		120		2000		2000		1		GR	FLT 225-5-37-P CST 225-2LF	93 C/HLD 225-1	97
Boron oxide (total dust)	OSHA CSI			15 mg/m³	480			2000		4		ICP-AES	FLT 225-5-37-P CST 225-2LF	93 C/HLD 225-1	97
Boron tribromide	OSHA CSI				5			1000		5		IC	IMP 225-36-2	67 IT 225-22	67
Boron trifluoride	OSHA CSI			1 (C)	15			1000		15		ISE	IMP 225-36-2	67 IT 225-22	67
Botran	OSHA CSI			400		1000		1000		6.7		HPLC-UV	F/CST 225-706	96 C/HLD 225-1	102
Bromacil	OSHA CSI			50		1000		1000		50 min		HPLC-UV	IMP 225-36-1	67 IT 225-22	67
Bromine	NIOSH 6011	1329	0.1	0.3	240	15	1000	1000	4	15		IC	CF/CST 225-9006	64 C/HLD 225-1	102
Bromine	OSHA ID 108		0.1	120	7.5	500	500	500	4	15		IC	IMP 225-36-2	67 IT 225-22	67
Bromine pentafluoride	OSHA CSI			48		200		200		4		IC	ST 226-10-03	38	
Bromoethane (ethyl bromide)	NIOSH 1011			4		20(50)		20(50)		3.3(1.3)		GC-FID	ST 226-01	38	

Agency standards for OSHA listings represent the OSHA PELs reported in the 29 CFR 1910.1000 Part 1910, Section 1000.

References and abbreviations are found on pages 212-213.

Chemical Hazard	Agency Reference	Chem F File	SAMPLING ∞								Analytical Method	SKC Collecting Equipment & Page Number			
			Agency Standard		Vol. (liter)		Rate (ml/min)		Time						
			TWA (ppm)	CLG/STEL (ppm)	TWA	CLG/STEL	TWA	CLG/STEL	TWA (hrs)	CLG/STEL (min)					
Bromoform	OSHA 07	1127	0.5	10	20(50)	8(3.3)				GC-FID	ST	226-01	38		
Bromoform (hydrocarbons, halogenated)	NIOSH 1003		0.5 (skin)	10	10-200	varies				GC-FID	ST	226-01	38		
1-Bromopropane	NIOSH 1025			0.1-12	10-200	varies				GC-FID	ST	226-01	38		
1-Bromopropane	OSHA 1017			12	50	240 (min)				GC-FID	ST	226-01	38		
1-Bromopropane	OSHA PV2061			12	100	2				GC-FID	ST	226-01	38		
2-Bromopropane	NIOSH 1025			0.1-12	10-200	varies				GC-FID	ST	226-01	38		
2-Bromopropane	OSHA 1017			12	50	240 (min)				GC-FID	ST	226-01	38		
2-Bromopropane	OSHA PV2062			12	100	2				GC-FID	ST	226-01	38		
Bromotrifluoromethane (trifluorobromomethane)	NIOSH 1017	1000		0.3	20	15 min				GC-FID	ST	226-09	38	ST	226-01 38
Bromoxynil	NIOSH 5010			240	1000	4				HPLC-UV	F/CST	225-1713	94	C/HLD	225-1 102
Bromoxynil octanoate	NIOSH 5010			240	1000	4				HPLC-UV	F/CST	225-1713	94	C/HLD	225-1 102
Bronkosol	OSHA CSI			480	1000	8				HPLC	F/CST	225-706	96	C/HLD	225-1 102
Brucine	OSHA CSI			180	1000	3				HPLC-UV	F/CST	225-706	96	C/HLD	225-1 102
BTEX (hydrocarbons, aromatic. See benzene, toluene, ethylbenzene, and xylene)	NIOSH 1501		varies	varies	varies	varies				GC-FID	ST	226-01	38		
1,3-Butadiene	NIOSH 1024	1010	LFC	10	20	8				GC-FID	ST	226-37	39		
1,3-Butadiene	OSHA 56	1011	1 5	3	50	1				GC-FID	ST	226-73	39		
Butane	OSHA CSI			10	20(50)	8(3.3)				GC-FID	ST	226-01	38		
1,3-Butanediol	OSHA CSI			60	2000	30 min				GC-FID	ST	226-57	39		
1-Butanethiol (butyl mercaptan)	NIOSH 2525		0.5	1	50	15				GC-SPD	ST	226-109	40		
n-Butanol (alcohols combined)	NIOSH 1405		50 (skin)	2-10	10-200	varies				GC-FID	ST	226-01	38		
2-Butanone	EPA TO-17	1689		1 L & 4 L	16.7 ml/min & 66.7 ml/min					TD, GC	ST	226-300 Series 224-26-CPC	42 51	TH	224-26-02 51
2-Butanone	OSHA 1004	200		12	50	4				GC-FID	ST	NA SKC			
2-Butanone (Ketones I)	NIOSH 2555			1-10	10-200	varies				GC-FID	ST	NA SKC			
2-Butanone (methyl ethyl ketone)	NIOSH 2500	1012	200 300	10 3	20(50) 200	8(3.3) 15				GC-FID	ST	226-81A	39		
2-Butanone (methyl ethyl ketone)	OSHA 1004	200			16.88	8				GC-FID	PS	575-002	75		
2-Butanone (methyl ethyl ketone)	OSHA 16	1282	200	3 1.5	100 100	30 min 15				GC-FID	ST	226-10	38		
2-Butanone (methyl ethyl ketone)	OSHA 84	200		3 0.75	50 50	1 15				GC-FID	ST	NA SKC			
Butene	OSHA CSI			1	20	50 min				GC-FID	ST	226-01	38		
2-Butoxyethanol (alcohols IV)	NIOSH 1403	1275	5 (skin)	2-10	10-50	varies				GC-FID	ST	226-01	38		
2-Butoxyethanol (butyl CELLOSOLVE solvent)	OSHA 83	50		48	100	8				GC-FID	ST	226-01	38		
2-Butoxyethanol acetate	EPA TO-17	1689		1 L & 4 L	16.7 ml/min & 66.7 ml/min					TD, GC	ST	226-300 Series 224-26-CPC	42 51	TH	224-26-02 51
2-Butoxyethanol acetate (butyl CELLOSOLVE acetate)	OSHA 83			48	100	8				GC-FID	ST	226-01	38		
n-Butyl acetate	EPA TO-17	1689		1 L & 4 L	16.7 ml/min & 66.7 ml/min					TD, GC	ST	226-300 Series 224-26-CPC	42 51	TH	224-26-02 51
n-Butyl acetate	OSHA 07	150		10 3	20(50) 200	8(3.3) 15				GC-FID	ST	226-01	38		
n-Butyl acetate	OSHA 1009	1750	150	12 0.75	50 50	4 15				GC-FID	ST	226-01	38		
n-Butyl acetate	OSHA 1009	1750	150		13.07 13.07	8 15				GC-FID	PS	575-002	75		
sec-Butyl acetate	OSHA 07	200		10	20(50)	8(3.3)				GC-FID	ST	226-01	38		
sec-Butyl acetate	OSHA 1009	1750	200	12 0.75	50 50	4 15				GC-FID	ST	226-01	38		
sec-Butyl acetate	OSHA 1009	1750	200		12.74 12.74	8 15				GC-FID	PS	575-002	75		
t-Butyl acetate	EPA TO-17	1689		1 L & 4 L	16.7 ml/min & 66.7 ml/min					TD, GC	ST	226-300 Series 224-26-CPC	42 51	TH	224-26-02 51
t-Butyl acetate	OSHA 07	200		10	20(50)	8(3.3)				GC-FID	ST	226-01	38		
t-Butyl acetate	OSHA 1009	1750	200	12 0.75	50 50	4 15				GC-FID	ST	226-01	38		
t-Butyl acetate	OSHA 1009	1750	200		13.09 13.09	8 15				GC-FID	PS	575-002	75		
n-Butyl acetate (Esters I)	NIOSH 1450	1272	150 200	1-10 1-10	10-200 10-200	varies varies				GC-FID	ST	226-01	38		
sec-Butyl acetate (Esters I)	NIOSH 1450	200		1-10	10-200	varies				GC-FID	ST	226-01	38		
t-Butyl acetate (Esters I)	NIOSH 1450	200		1-10	10-200	varies				GC-FID	ST	226-01	38		
Butyl acrylate	OSHA PV2011			12	50	4				GC-FID	ST	226-73	39		
n-Butyl acrylate	NON 54	5	15	10 3	20 200	8 15				GC-FID	ST	226-81A	39		
n-Butyl alcohol	EPA TO-17	1689		1 L & 4 L	16.7 ml/min & 66.7 ml/min					TD, GC	ST	226-300 Series 224-26-CPC	42 51	TH	224-26-02 51
n-Butyl alcohol	OSHA 07	100		10 1	20 200	8 5				GC-FID	ST	226-01	38		
sec-Butyl alcohol	OSHA 07	150		10	20(50)	8(3.3)				GC-FID	ST	226-01	38		
t-Butyl alcohol	OSHA 07	100		10 3	20(50) 200	8(3.3) 15				GC-FID	ST	226-01	38		
n-Butyl alcohol (alcohols combined)	NIOSH 1405		50 (skin)	2-10	10-200	varies				GC-FID	ST	226-01	38		
sec-Butyl alcohol (alcohols combined)	NIOSH 1405		100 150	2-10 2-10	10-200 10-200	varies varies				GC-FID	ST	226-01	38		
t-Butyl alcohol (Alcohols I)	NIOSH 1400		100 150	10	20(50)	8(3.3)				GC-FID	ST	226-01	38		

B

Agency standards for OSHA listings represent the OSHA PELs reported in the 29 CFR 1910.1000 Part 1910, Section 1000.

References and abbreviations are found on pages 212-213.

Sampling Guide

www.skinc.com for updates

B

Chemical Hazard	Agency Reference	Chem F File	SAMPLING ∞								Analytical Method	SKC Collecting Equipment & Page Number				
			Agency Standard		Vol. (liter)		Rate (ml/min)		Time							
			TWA (ppm)	CLG/STEL (ppm)	TWA (Sample Time or Air Volume)	CLG/STEL	TWA (Flow/Sampling Rate)	CLG/STEL	TWA (hrs)	CLG/STEL (min)						
n-Butyl alcohol (alcohols II)	NIOSH 1401		50	10	3	20(50)	200	8(3.3)	15	GC-FID	ST	226-01	38			
sec-Butyl alcohol (alcohols II)	NIOSH 1401		100	150	10	3	20(50)	200	8(3.3)	15	GC-FID	ST	226-01	38		
Butyl benzyl phthalate	OSHA CSI				180		1000		3	HPLC-UV	F/CST	225-706	96	C/HLD	225-1 102	
Butyl butyrate	OSHA PV2090				10		200		50 min	GC-FID	ST	226-01	38			
Butyl carbitol (diethylene glycol monobutyl ether)	OSHA PV2095				10		200		50 min	GC-FID	ST	226-01	38			
Butyl carbitol acetate	OSHA PV2095				10		200		50 min	GC-FID	ST	226-01	38			
Butyl CELLOSOLVE acetate (see 2-butoxyethanol acetate)	OSHA 83															
Butyl CELLOSOLVE solvent (see 2-butoxyethanol)	OSHA 83															
t-Butyl chromate (as CrO ₃)	OSHA ID 215 (V2)	1439	0.005 mg/m ³		960		2000		15	IC-UV	F/CST	225-802	93	C/HLD	225-1 102	
n-Butyl glycidyl ether	NIOSH 1616			5.6 (15 min)		3		200		15	GC-FID	ST	226-01	38		
n-Butyl glycidyl ether	OSHA 07	1125	50		10		20(50)		8(3.3)	GC-FID	ST	226-01	38			
t-Butyl glycidyl ether	OSHA CSI				10		200		50 min	GC-FID	ST	226-01	38			
Butyl isocyanate	OSHA CSI				15		50		5	HPLC-UV	ST	NA SKC				
n-Butyl lactate	OSHA PV2080				10		200		50 min	GC-FID	ST	226-01	38			
n-Butyl mercaptan	NIOSH 2525		0.5		1		50		15	GC-FFD	ST	226-109	40			
Butyl mercaptan (butanethiol)	OSHA CSI		10		1.5		25		1	GC-FFD	ST	226-109	40			
n-Butyl mercaptan (mercaptans)	NIOSH 2542	1330	0.5 (15 min)		48	12	100	200	8	60	GC-FFD	CF/CST	225-9007	64	C/HLD	225-1 102
t-Butyl methyl ether	OSHA CSI				96		200		8	GC-FID	ST	226-37	39			
t-Butyl methyl ether (MTBE)	EPA TO-17	1689			1 L & 4 L		16.7 ml/min & 66.7 ml/min				TD, GC	ST 226-300 Series CPC	42 TH 224-26-02 51			
Butyl ziram	OSHA PV2065				180		1000		3	HPLC-UV	ST	226-30-16	38			
N-t-Butyl-2-benzothiazolesulfenamide	OSHA CSI				120		1000		2	HPLC-UV	F/CST	225-709	96	C/HLD	225-1 102	
Butylamine	OSHA CSI		5 (C)		5		1000		5	GC-FID	ST	226-53	39			
n-Butylamine	NIOSH 2012		5		15		1000		15	GC-FID	ST	226-53	39			
Butylated hydroxytoluene	OSHA PV2108				100		1000		100 min	GC-FID	ST	226-57	39			
sec-Butylbenzene	OSHA CSI				6		100		1	GC-FID	ST	226-01	38			
1,3-Butylene glycol (glycols)	NIOSH 5523	1404			60		1000		1	GC-FID	ST	226-57	39			
o-sec-Butylphenol	OSHA PV 2128				20		200		1.6	HPLC-UV	ST	226-95	40			
p-tert-Butylphenol	OSHA PV2085				20		200		100 min	GC-FID	ST	226-95	40			
Butyltin trichloride	OSHA ID 2175G				240		1000		4	AA-GF	ST	226-30-16	38			
p-tert-Butyltoluene	OSHA 07	1129	10		10	3	20(50)	200	8(3.3)	15	GC-FID	ST	226-01	38		
p-tert-Butyltoluene (Hydrocarbons, Aromatic)	NIOSH 1501		10	20	1-29	1-29	10-200	10-200	varies	varies	GC-FID	ST	226-01	38		
Butyraldehyde	ASTM D 5197				varies		500-1200		5 min-24 hrs		HPLC-UV	ST	226-120 °	or	ST 226-119 40	
Butyraldehyde (Aldehydes, Screening)	NIOSH 2539				5		20		4		GC-FID & GC-MS	ST	226-118	40		
Butyric acid	OSHA CSI				18		100		3	GC-FID	ST	226-15	38			
beta-Butyrolactone	OSHA CSI				9.6		20		8	GC-FID	ST	226-01	38			
gamma-Butyrolactone	OSHA CSI				10		20(50)		8(3.3)	GC-FID	ST	226-01	38			
Cadmium	OSHA ID 189	1456	5 µg/m ³		960		2000		8	15	AA	F/CST	225-3-01	90	C/HLD	225-1 102
Cadmium & compounds (as Cd)	NIOSH 7048	1467	LFC		480	30	1000	2000	8	15	AA-F	F/CST	225-3-01	90	C/HLD	225-1 102
Cadmium (Elements by Cellulosic Internal Capsule Sampler)	NIOSH 7306		LFC		3-2000		1000-4000		Varies		ICP-AES	SC	225-8517	90	C/HLD	225-1 102
Cadmium (Elements by ICP Aqua Regia Ashing)	NIOSH 7301		LFC		13-2000		1000-4000		varies		ICP-AES	F/CST	225-3-01	or	F/CST 225-803 ¥ 93	
Cadmium (Elements by ICP HNO ₃ Digestion)	NIOSH 7303				3-500,000		1000-4000		varies		ICP-AES	F/CST	225-3-01	90	C/HLD	225-1 102
Cadmium (Elements by ICP HNO ₃ /HClO ₄ Ashing)	NIOSH 7300	1280	LFC		13-2000		1000-4000		varies		ICP-AES	F/CST	225-3-01	90	C/HLD	225-1 102
Cadmium (Elements on Wipes)	NIOSH 9102				wipe						ICP-AES	W	225-2414	140	TMP	225-2403 or
											TMP	225-2415	140			
Cadmium dust (as Cd)	OSHA ID 121		0.2 mg/m ³	0.5 mg/m ³	960	30	2000	2000	8	15	AA	F/CST	225-3-01	90	C/HLD	225-1 102
Cadmium dust (as Cd)	OSHA ID 206		0.2 mg/m ³	0.5 mg/m ³	960	30	2000	2000	8	15	ICP-AES	F/CST	225-3-01	90	C/HLD	225-1 102
Cadmium fume (ICP analysis of metal/metalloid particulates from solder operations)	OSHA ID 206		0.1 mg/m ³	0.3 mg/m ³ (C)	480		2000		4		ICP-AES	F/CST	225-3-01	90	C/HLD	225-1 102
Calcium & compounds (as Ca)	NIOSH 7020		varies		240		1000		4		AA-F	F/CST	225-3-01	90	C/HLD	225-1 102
Calcium (Elements by Cellulosic Internal Capsule Sampler)	NIOSH 7306				Varies		1000-4000		Varies		ICP-AES	SC	225-8517	90	C/HLD	225-1 102
Calcium (Elements by ICP Aqua Regia Ashing)	NIOSH 7301		varies		5-200		1000-4000		varies		ICP-AES	F/CST	225-3-01	or	F/CST 225-803 ¥ 93	
											C/HLD	225-1	102			
Calcium (Elements by ICP HNO ₃ Digestion)	NIOSH 7303				2-10,000		1000-4000		varies		ICP-AES	F/CST	225-3-01	90	C/HLD	225-1 102
Calcium (Elements by ICP HNO ₃ /HClO ₄ Ashing)	NIOSH 7300	1455	varies		5-200		1000-4000		varies		ICP-AES	F/CST	225-3-01	90	C/HLD	225-1 102
Calcium (see specific compounds)	NIOSH 7020		varies		varies		varies		varies		AA-F	F/CST	225-3-01	90	C/HLD	225-1 102

Agency standards for OSHA listings represent the OSHA PELs reported in the 29 CFR 1910.1000 Part 1910, Section 1000.

References and abbreviations are found on pages 212-213.

Chemical Hazard	Agency Reference	Chem F File	SAMPLING ∞								Analytical Method	SKC Collecting Equipment & Page Number					
			Agency Standard		Vol. (liter)		Rate (ml/min)		Time								
			TWA (ppm)	CLG/STEL (ppm)	TWA (Sample Time or Air Volume)	CLG/STEL	TWA (Flow/Sampling Rate)	CLG/STEL	TWA (hrs)	CLG/STEL (min)							
Calcium arsenate (as As)	OSHA CSI				600		2000		5		AA-GF	F/CST	225-3-01	90	C/HLD	225-1	102
Calcium bromide (see dust, total & respirable nuisance)	OSHA CSI																
Calcium carbonate	OSHA ID 121		15 mg/m ³		960		2000		8		AA or AES	F/CST	225-3-01	90	C/HLD	225-1	102
Calcium carbonate (calcium)	NIOSH 7020		2 mg/m ³		240		1000		4		AA-F	F/CST	225-3-01	90	C/HLD	225-1	102
Calcium carbonate (particulates, respirable)	NIOSH 0600	1038			375		2500		2.5		GR	FLT CYC	225-5-37-P 225-01-02	93 111	C/HLD CST	225-1 225-3LF	102 97
Calcium carbonate (particulates, total)	NIOSH 0500	1035			120		2000		1		GR	FLT CST	225-5-37-P 225-2LF	93 97	C/HLD	225-1	102
Calcium carbonate (see dust, total & respirable nuisance)																	
Calcium cyanamide	OSHA ID 121				960		2000		8		AA or AES	F/CST	225-3-01	90	C/HLD	225-1	102
Calcium hydroxide	OSHA ID 121		5 mg/m ³		960		2000		8		AA or AES	F/CST	225-3-01	90	C/HLD	225-1	102
Calcium hydroxide (calcium)	NIOSH 7020		2 mg/m ³		240		1000		4		AA-F	F/CST	225-3-01	90	C/HLD	225-1	102
Calcium hydroxide (see dust, total & respirable nuisance)																	
Calcium oxide	OSHA ID 121		5 mg/m ³		960		2000		8		AA or AES	F/CST	225-3-01	90	C/HLD	225-1	102
Calcium oxide (calcium)	NIOSH 7020		2 mg/m ³		240		1000		4		AA-F	F/CST	225-3-01	90	C/HLD	225-1	102
Calcium oxide (Elements by ICP HNO ₃ Digestion)	NIOSH 7303		2 mg/m ³		3-10,000		1000-4000		varies		ICP-AES	F/CST	225-3-01	90	C/HLD	225-1	102
Calcium silicate (particulates, respirable)	NIOSH 0600	1038			375		2500		2.5		GR	FLT CYC	225-5-37-P 225-01-02	93 111	C/HLD CST	225-1 225-3LF	102 97
Calcium silicate (particulates, total)	NIOSH 0500	1035			120		2000		1		GR	FLT CST	225-5-37-P 225-2LF	93 97	C/HLD	225-1	102
Calcium sulfate (see dust, total & respirable nuisance)																	
Camphor	OSHA 07	1130	2 mg/m ³		10		20(50)		8(3.3)		GC-FID	ST	226-01	38			
Camphor (Ketones I)	NIOSH 2553		2		1-25		10-200		varies		GC-FID	ST	NA SKC				
Camphor (Ketones II)	NIOSH 1301		2		10		20(50)		8(3.3)		GC-FID	ST	226-01	38			
Caprolactam	OSHA PV2012				100		1000		100 min		HPLC-UV	ST	226-57	39			
Capsaicin	NIOSH 5041				480	15	1000	1000	8	15	HPLC-FD	FLT	225-16	96	CST	225-32	102
Captafol (difolatan)	OSHA CSI				240		1000		4		GC-ECD	ST	226-30-16	38			
Captan	ASTM D 4861				240-7200		1000-5000		4-24		GC-ECD	PUF	226-92	44			
Captan	OSHA PV2093				60		1000		1		HPLC-UV	ST	226-30-16	38			
Captan (Organonitrogen Pesticides)	NIOSH 5601		5 mg/m ³		240		1000		4		HPLC-UV	ST	226-58	or	ST	226-30-16	38
Carbadox	OSHA CSI				120		1000		2		HPLC-UV	F/CST	225-706	96	C/HLD	225-1	102
Carbaryl	ASTM D 4861				240-7200		1000-5000		4-24		HPLC-UV	PUF	226-92	44			
Carbaryl (Organonitrogen Pesticides)	NIOSH 5601		5 mg/m ³		240		1000		4		HPLC-UV	ST	226-58	or	ST	226-30-16	38
Carbaryl (Sevin)	NIOSH 5006		5 mg/m ³		240		1000		4		VAS	F/CST	225-706	96	C/HLD	225-1	102
Carbaryl (Sevin)	OSHA 63		5 mg/m ³		60		1000		1		HPLC-UV	ST	226-30-16	38			
Carbazol	OSHA CSI				120		1000		2		GC-FID	ST	226-56	39			
Carbendazim (Organonitrogen Pesticides)	NIOSH 5601				240		1000		4		HPLC-UV	ST	226-58	or	ST	226-30-16	38
Carbitol	OSHA PV2013				10		200		50 min		GC-FID	ST	226-01	38			
Carbitol acetate	OSHA PV2013				10		200		50 min		GC-FID	ST	226-01	38			
Carbofuran	ASTM D 4861				240-7200		1000-5000		4-24		HPLC-UV	PUF	226-92	44			
Carbofuran (Organonitrogen Pesticides)	NIOSH 5601		0.1 mg/m ³		240		1000		4		HPLC-UV	ST	226-58	or	ST	226-30-16	38
Carbon black	NIOSH 5000		3.5 mg/m ³		360		1500		4		GR	FLT SCN	225-5-37-P 225-26	93 103	CST C/HLD	225-3LF 225-1	97 102
Carbon black	OSHA ID 196		3.5 mg/m ³		960		2000		8		GR	FLT CST	225-5-37-P 225-2LF	93 97	C/HLD	225-1	102
Carbon dioxide	OSHA ID 172	1026	5000	30,000	2-5	2-5	10-50	300	4-8	15	GC-TCD	SB	253 Series	or	SB	263 Series	56
Carbon dioxide (by portable GC)	NIOSH 6603	1027	5000	30,000	varies	varies	20-100	20-100	varies	varies	P GC-TCD	SB	232 Series				55
Carbon disulfide	NIOSH 1600		1	10	10	3	20(50)	200	8(3.3)	15	GC-FPD	ST	226-01	38	DRT	226-44	39
Carbon monoxide	OSHA ID 209		50								DRI	DRI	805-18970				
Carbon monoxide	OSHA ID 210	1021	50		2-5	2-5	10-50	1000	varies	varies	GC-DID	SB SB	252 Series 262 Series	or or	SB SB	253 Series 263 Series	or 56
Carbon tetrabromide	OSHA CSI				9	3	50	200	3	15	GC-ECD	ST	226-93	40			
Carbon tetrachloride	ASTM D 5466				6		varies		varies		GC-MS	CAN	228 Series		PK	228 Series	
Carbon tetrachloride	EPA TO-17	1689			1 L & 4 L		16.7 ml/min & 66.7 ml/min				TD, GC	ST CPC	226-300 Series 224-26-CPC	42 51	TH	224-26-02	51
Carbon tetrachloride	OSHA 07	1131	10	25	15	3	50	200	5	15	GC-FID	ST	226-01	38			
Carbon tetrachloride (hydrocarbons, halogenated)	NIOSH 1003			2 (1 hr)		15		10-200		varies	GC-FID	ST	226-01	38			
Carbon, activated (see dust, total nuisance)																	
Carbonyl fluoride	OSHA CSI				480		2000		4		ISE	IMP	225-36-2	67	IT	225-22	67

Agency standards for OSHA listings represent the OSHA PELs reported in the 29 CFR 1910.1000 Part 1910, Section 1000.

References and abbreviations are found on pages 212-213.

Sampling Guide

www.skinc.com for updates

C

Chemical Hazard	Agency Reference	Chem F File	SAMPLING ∞								Analytical Method	SKC Collecting Equipment & Page Number					
			Agency Standard		Vol. (liter)		Rate (ml/min)		Time								
			TWA (ppm)	CLG/STEL (ppm)	TWA (Sample Time or Air Volume)	CLG/STEL	TWA (Flow/Sampling Rate)	CLG/STEL	TWA (hrs)	CLG/STEL (min)							
Carboxin	OSHA CSI			200		1000		3.3		HPLC-UV	F/CST	225-709	96	C/HLD	225-1	102	
3-Carene (terpenes)	NIOSH 1552			24		50		8		GC-FID	ST	226-01	38				
Catechol (pyrocatechol)	OSHA PV2014			100		1000		100 min		HPLC-UV	ST	226-57	39				
Cell fragments (bioaerosols)				15-150		15000		1-10 min		varies	STC	225-9820	101				
CELLOSOLVE acetate (see 2-ethoxyethyl acetate)																	
CELLOSOLVE solvent (see 2-ethoxyethanol) (alcohols IV)	NIOSH 1403	1273															
Cellulose (paper fiber) (particulates, respirable)	NIOSH 0600	1038		375		2500		2.5		GR	FLT CYC	225-5-37-P 225-01-02	93 111	C/HLD CST	225-1 225-3LF	102 97	
Cellulose (paper fiber) (particulates, total)	NIOSH 0500	1035		120		2000		1		GR	FLT CST	225-5-37-P 225-2LF	93 97	C/HLD	225-1	102	
Cellulose (see dust, total or respirable nuisance)																	
Cellulose insulation	NIOSH 7404			varies		1000		varies		SEM	FLT/CL	225-1604	93				
Cerium	OSHA ID 121			960		2000		8		AA or AES	F/CST	225-3-01	90	C/HLD	225-1	102	
Cesium hydroxide	OSHA CSI			960		2000		8		AA	F/CST	225-3-01	90	C/HLD	225-1	102	
Chaetomium species (fungi, molds, spores)	OSHA CSI			120		1000		2		varies	F/CST	225-3-01	90	C/HLD	225-1	102	
Chaetomium species (fungi, molds, spores)	OSHA CSI			141.5		28300		5 min		varies	BI	225-9611	120				
Chloramphenicol	OSHA CSI			60		1000		1		HPLC-UV	F/CST	225-709	96	C/HLD	225-1	102	
Chlordane	NIOSH 5510		0.5 mg/m ³	150		1000		2.5		GC-ECD	ST CST C/HLD	226-107 225-2LF 225-1	40 97 102	FLT SCN	225-5 225-26	88 103	
Chlordane	OSHA 67	1013	0.5 mg/m ³	480		1000		8		GC-ECD	ST	226-30-16	38				
Chlordane (non-occupational exposure)	ASTM D 4947	1417		240-7200		1000-5000		4-24		GC-ECD	PUF	226-92	44				
Chlordane (technical)	ASTM D 4861			240-7200		1000-5000		4-24		GC-ECD	PUF	226-92	44				
Chlorinated & organonitrogen herbicides	NIOSH 5602			480		1000		8		GC-ECD	ST	226-58	39				
Chlorinated & organonitrogen herbicides (hand wash)	NIOSH 9200									GC-ECD	NA SKC						
Chlorinated camphene (Toxaphene)	NIOSH 5039		LFC	30	15	1000	1000	0.5	15	GC-ECD	F/CST	225-3-01	90	C/HLD	225-1	102	
Chlorinated diphenyl ether (chlorinated diphenyl oxide)	NIOSH 5025		0.5 mg/m ³	180		1000		3		GC-ECD	F/CST	225-3-01	90	C/HLD	225-1	102	
Chlorinated diphenyl oxide	NIOSH 5025		0.5 mg/m ³	90		1000		1.5		GC-ECD	F/CST	225-3-01	90	C/HLD	225-1	102	
Chlorinated hydrocarbons (screening)	NIOSH 2549			5		20		4		GC-MS	ST	226-330	42				
Chlorinated terphenyl (60% chlorine)	NIOSH 5014			720		1500		8		GC-ECD	F/CST	225-706	96	C/HLD	225-1	102	
Chlorine	NIOSH 6011	1332	0.5	1	90	15	1000	1000	1.5	15	IC	CF/CST	225-9006	64	C/HLD	225-1	102
Chlorine	OSHA ID 101	1052		1 (C)	240	15	1000	1000	4	15	ISE	IMP	225-36-2	67	IT	225-22	67
Chlorine (prefiltered)	OSHA ID 101	1289		1 (C)	240	15	1000	1000	4	15	ISE	IMP CST FLT	225-36-2 225-3-23 225-2708	67 97 94	IT SP	225-22 225-2901	67 103
Chlorine dioxide	OSHA ID 202	1462	0.1		120	7.5	500	500	4	15	IC-CD	IMP	225-36-2	67	IT	225-22	67
Chlorine trifluoride	OSHA CSI			0.1		15		1000		15	ISE	IMP	225-36-2	67	IT	225-22	67
1-Chloro-1-nitropropane	OSHA CSI		20		12		50		4		GC-FID	ST	NA SKC				
5-Chloro-2-methyl-4-isothiazolin-3-one (Kathon 886)	NON 55		0.75 mg/m ³	0.23 mg/m ³	50	7.5	200	500	4	15	HPLC-UV	ST	226-99	40			
1-Chloro-4-(trifluoromethyl)benzene (parachlorobenzotrifluoride)	OSHA CSI				6		100		1		GC-FID	ST	226-01	38			
2-Chloro-6-trichloromethyl pyridine (respirable dust)	OSHA CSI		15 mg/m ³		480		1000		8		HPLC-UV	ST	226-30-16	38	CYC	225-105	110
2-Chloro-6-trichloromethyl pyridine (total dust)	OSHA CSI		5 mg/m ³		varies		varies	varies			HPLC-UV	ST	226-30-16	38			
Chloroacetaldehyde	NIOSH 2015			1		3		200		15	GC-ECD	ST	226-15GWS	38			
Chloroacetaldehyde	OSHA 76			1 (C)		2.5		500		5	GC-ECD	ST	226-15GWS	38			
Chloroacetic acid	NIOSH 2008				48		100		8		IC-CD	ST	226-47-01	39			
alpha-Chloroacetophenone (phenacylchloride)	OSHA CSI		0.05		12		200		1		HPLC-UV	ST	226-35-02	38			
Chloroacetyl chloride	OSHA CSI				10		50		3.3		HPLC-UV	ST	NA SKC				
o-Chloroaniline	OSHA CSI				5		20		4		HPLC-UV	ST	226-10	38			
p-Chloroaniline	OSHA PV2109				6		100		1		HPLC-UV	ST	226-10	38			
Chlorobenzene	EPA TO-17	1689			1 L & 4 L		16.7 ml/min & 66.7 ml/min				TD, GC	ST CPC	226-300 Series 224-26-CPC	42 51	TH	224-26-02	51
Chlorobenzene (monochlorobenzene)	ASTM D 5466				6		varies		varies		GC-MS	CAN	228 Series	PK	228 Series		
Chlorobenzene (monochlorobenzene)	OSHA 07	1132	75		10		20(50)		8(3,3)		GC-FID	ST	226-01	38			
Chlorobenzene (monochlorobenzene) (hydrocarbons, halogenated)	NIOSH 1003				10		10-200		varies		GC-FID	ST	226-01	38			
4-Chlorobenzotrifluoride	NIOSH 1026				0.1-10.0		10-200		varies		GC-FID	ST	226-01	38			
4-Chlorobenzotrifluoride	OSHA CSI				6		100		1		GC-FID	ST	226-01	38			
p-Chlorobenzotrifluoride	NIOSH 1026				0.1-10.0		10-200		varies		GC-FID	ST	226-01	38			
p-Chlorobenzotrifluoride	OSHA CSI				6		100		1		GC-FID	ST	226-01	38			
Chlorobiphenyl	NIOSH 5503		0.001 mg/m ³ (10 hr)		48		100(200)		8(4)		GC-ECD	FLT ST	225-16 226-39	96 39	CST	225-32	102

Agency standards for OSHA listings represent the OSHA PELs reported in the 29 CFR 1910.1000 Part 1910, Section 1000.

References and abbreviations are found on pages 212-213.

Chemical Hazard	Agency Reference	Chem F File	SAMPLING ∞								Analytical Method	SKC Collecting Equipment & Page Number			
			Agency Standard		Vol. (liter)		Rate (ml/min)		Time						
			TWA (ppm)	CLG/STEL (ppm)	TWA (Sample Time or Air Volume)	CLG/STEL	TWA (Flow/Sampling Rate)	CLG/STEL	TWA (hrs)	CLG/STEL (min)					
Chlorobromomethane	OSHA CSI		200	5		20		4		GC-FID	ST	226-01	38		
Chlorobromomethane (hydrocarbons, halogenated)	NIOSH 1003		200	5		10-200		varies		GC-FID	ST	226-01	38		
Chlorodifluoromethane	OSHA CSI			1		50		20 min		GC-FID	ST	NA SKC			
Chlorodiphenyl	OSHA CSI			60		1000		1		GC-ECD	ST	226-30-16	38		
Chlorodiphenyl (21% Cl) (see polychlorinated biphenyls)	OSHA CSI														
Chlorodiphenyl (32% Cl) (see polychlorinated biphenyls)	OSHA CSI														
Chlorodiphenyl (42% Cl)	OSHA PV2089			1	60		1000	1		GC-ECD	ST	226-30-16	38		
Chlorodiphenyl (42% Cl) (see polychlorinated biphenyls)	NIOSH 5503														
Chlorodiphenyl (48% Cl) (see polychlorinated biphenyls)	OSHA CSI														
Chlorodiphenyl (54% Cl)	OSHA PV2088			0.5	60		1000	1		GC-ECD	ST	226-30-16	38		
Chlorodiphenyl (54% Cl) (see polychlorinated biphenyls)	NIOSH 5503														
Chlorodiphenyl (60% Cl) (see polychlorinated biphenyls)	OSHA CSI														
Chlorodiphenyl (62% Cl) (see polychlorinated biphenyls)	OSHA CSI														
Chloroethane (ethyl chloride)	NIOSH 2519				3		50	1		GC-FID	ST	226-09	38		
2-Chloroethanol (ethylene chlorohydrin)	NIOSH 2513			1	10		20(50)	8(3.3)		GC-FID	ST	226-81A	39		
Chloroform (trichloromethane)	ASTM D 5466				6		varies	varies		GC-MS	CAN	228 Series	PK	228 Series	
Chloroform (trichloromethane)	OSHA 05	1062		50 (C)	10		200	50 min		GC-FID	ST	226-01	38		
Chloroform (trichloromethane) (hydrocarbons, halogenated)	NIOSH 1003	1269		2		15		10-200		GC-FID	ST	226-01	38		
bis-Chloromethyl ether	OSHA 10				50		500	100 min		GC-ECD	IMP	225-36-2	67	IT	225-22 67
Chloromethyl methyl ether	NON 29	1251			2.4	0.3	10	20	4	15	GC-ECD	ST	NA SKC		
Chloromethyl methyl ether	OSHA 10				50		500	100 min		GC-ECD	IMP	225-36-2	67	IT	225-22 67
4-Chloronitrobenzene (nitrobenzenes)	NIOSH 2005		0.1 ppm		96		200	8		GC-FID	ST	226-10	38		
Chloropentafluoroethane	OSHA CSI				2.5		50	50 min		GC-FID	ST	226-01	38		
Chlorophene	OSHA CSI				10		20(50)	8(3.3)		GC-FID	ST	226-35	38		
o-Chlorophenol	OSHA CSI				40		200	3.3		HPLC-UV	ST	226-10	38		
p-Chlorophenol	NIOSH 2014				24		50	8		HPLC-UV	ST	226-10	38		
Chloropicrin	NON 51		0.1		144		100	24		GC-MSD	ST	226-175	41		
Chloropicrin	OSHA PV2103		0.1		3		200	15 min		GC-ECD	ST	226-93	40		
beta-Chloroprene	NIOSH 1002			1 (15 min)		1.5		100		15	GC-FID	ST	226-01	38	
beta-Chloroprene	OSHA 07	1133	25		10		20(50)	8(3.3)		GC-FID	ST	226-01	38		
beta-Chloroprene	OSHA 112		25		6		50	2		GC-ECD	ST	226-111A	40		
o-Chlorostyrene	OSHA CSI				20	3	200	200	100 min	15	GC-FID	ST	226-01	38	
Chlorothalonil	ASTM D 4861				240-7200		1000-5000	4-24		GC-ECD	PUF	226-92	44		
Chlorothalonil	OSHA CSI				180		1000	3		HPLC-UV	F/CST	225-709	96	C/HLD	225-1 102
o-Chlorotoluene	OSHA CSI				20		200	100 min		GC-FID	ST	226-01	38		
Chlorotoluron	ASTM D 4861				240-7200		1000-5000	4-24		HPLC-UV	PUF	226-92	44		
Chlorotrifluoroethylene	OSHA CSI				10		200	50 min		GC-FID	ST	226-01	38		
Chlorpropham (Organonitrogen Pesticides)	NIOSH 5601				240		1000	4		HPLC-UV	ST	226-58	or	ST	226-30-16 38
Chlorpyrifos (Dursban)	ASTM D 4861				240-7200		1000-5000	4-24		GC-ECD	PUF	226-92	44		
Chlorpyrifos (Dursban)	OSHA 62	1394			480		1000	8		GC-FPD	ST	226-30-16	38		
Chlorpyrifos (Organophosphorus Pesticides)	NIOSH 5600		0.2 mg/m³		240		1000	4		GC-FPD	ST	226-58	39		
Chromic acid & chromates (as CrO₃)	OSHA ID 215 (V2)	1439	0.005 mg/m³		960		2000	8	15	IC-UV	F/CST	225-802 Ω	93	C/HLD	225-1 102
Chromic acid & chromates (chromium hexavalent)	NIOSH 7600		1 µg/m³ (10 hr)		240		1000	4		VAS	F/CST	225-803	93	C/HLD	225-1 102
Chromic acid & chromates (chromium hexavalent)	NIOSH 7604		1 µg/m³ (10 hr)		960		2000	8		IC-CD	F/CST	225-803	93	C/HLD	225-1 102
Chromium & compounds (as Cr)	NIOSH 7024	1457	0.5 mg/m³		10 - 1000		1000 - 3000	varies		AA-F	F/CST	225-3-01	or	F/CST	225-8410 90
Chromium (Elements by Cellulosic Internal Capsule Sampler)	NIOSH 7306		0.5 mg/m³		1-2000		1000-4000	Varies		ICP-AES	SC	225-8517	90	C/HLD	225-1 102
Chromium (Elements by ICP Aqua Regia Ashing)	NIOSH 7301		0.5 mg/m³		5-1000		1000-4000	varies		ICP-AES	F/CST	225-3-01	or	F/CST	225-803 ¥ 93
Chromium (Elements by ICP HNO₃ Digestion)	NIOSH 7303		0.5 mg/m³		8-500,000		1000-4000	varies		ICP-AES	F/CST	225-3-01	90	C/HLD	225-1 102
Chromium (Elements by ICP HNO₃/HClO₄ Ashing)	NIOSH 7300	1455	0.5 mg/m³		5-1000		1000-4000	varies		ICP-AES	F/CST	225-3-01	90	C/HLD	225-1 102
Chromium (Elements on Wipes)	NIOSH 9102				wipe					ICP-AES	W	225-2414	140	TMP	225-2403 or
											TMP	225-2415	140		

Agency standards for OSHA listings represent the OSHA PELs reported in the 29 CFR 1910.1000 Part 1910, Section 1000.

References and abbreviations are found on pages 212-213.

Sampling Guide

www.skcinc.com for updates

Chemical Hazard	Agency Reference	Chem F File	SAMPLING ∞										Analytical Method	SKC Collecting Equipment & Page Number			
			Agency Standard		Vol. (liter)		Rate (ml/min)		Time								
			TWA (ppm)	CLG/STEL (ppm)	TWA (Sample Time or Air Volume)	CLG/STEL	TWA (Flow/Sampling Rate)	CLG/STEL	TWA (hrs)	CLG/STEL (min)							
Chromium acetate	OSHA ID 121			960		2000		8		AA or AES	F/CST	225-3-01	90	C/HLD	225-1	102	
Chromium carbonate	OSHA ID 121			960		2000		8		AA or AES	F/CST	225-3-01	90	C/HLD	225-1	102	
Chromium metal & insoluble compounds	OSHA ID 121	1043	1 mg/m ³	960		2000		8		AA or AES	F/CST	225-3-01	90	C/HLD	225-1	102	
Chromium metal & insoluble compounds	OSHA ID 125G		1 mg/m ³	480		2000		4		ICP-AES	F/CST F/CST C/HLD	225-3-01 225-803 225-1	or or	F/CST F/CST	225-3100 225-8215	or 93	
Chromium phosphate	OSHA ID 121			960		2000		8		AA or AES	F/CST	225-3-01	90	C/HLD	225-1	102	
Chromium soluble salts (except hexavalent)	OSHA ID 121			960		2000		8		AA or AES	F/CST	225-3-01	90	C/HLD	225-1	102	
Chromium trioxide (CR(VI))	OSHA ID 215 (V2)	1439	0.005 mg/m ³	960		2000		8		IC-UV	F/CST	225-802 Ω	93	C/HLD	225-1	102	
Chromium, hexavalent	ASTM D 6832			varies		1000-5000		varies		IC	F/CST F/CST	225-802 225-709	or or	F/CST F/CST	225-1713 225-401	or 95	
Chromium, hexavalent	NIOSH 7600	1032	1 µg/m ³ (10 hr)	240		1000		4		VAS	F/CST	225-802	93	C/HLD	225-1	102	
Chromium, hexavalent	NIOSH 7604	1032	1 µg/m ³ (10 hr)	240		1000		4		IC-CD	F/CST	225-802	93	C/HLD	225-1	102	
Chromium, hexavalent	NIOSH 7605		0.001 mg/m ³ (10 hr)	1-400		1000-4000		varies		IC-PCD-UV	F/CST	225-802	93	C/HLD	225-1	102	
Chromium, hexavalent	NIOSH 7703		0.001 mg/m ³ (10 hr)	10-1200		1000-4000		varies		P VAS	F/CST	225-802	93	C/HLD	225-1	102	
Chromium, hexavalent	OSHA ID 103		0.005 mg/m ³ (C)	960	30	2000	2000	8	15	DPP	F/CST	225-802	93	C/HLD	225-1	102	
Chromium, hexavalent	OSHA W4001		0.005 mg/m ³ (C)							IC-UV	FLT	225-5-37	or	FLT	225-1822	95	
Chromium, hexavalent (CR(VI))	OSHA ID 215 (V2)	1439	0.005 mg/m ³	960		2000		8		IC-UV	F/CST	225-802 Ω	93	C/HLD	225-1	102	
Chromium, hexavalent (in settled dust)	NIOSH 9101			bulk	bulk					CLR or VAS or IC							
Chrysene	OSHA 58		0.2 mg/m ³	960		2000		8		GR & HPLC-FD, or GR & HPLC-UV	FLT C/HLD	225-7 225-1	96 102	CST	225-2LF	97	
Chrysene (Polynuclear Aromatic Hydrocarbons by GC-MS)	ASTM D 6209			350 m ³ (max)		225 L/min		1-24		GC-MS	PUF	226-131	45	FLT	225-1808	95	
Chrysene (Polynuclear Aromatic Hydrocarbons by GC)	NIOSH 5515		LFC	480		2000		4		GC-FID	F/CST C/HLD	225-1713 225-1	94 102	ST	226-30-04	38	
Chrysene (Polynuclear Aromatic Hydrocarbons by HPLC)	NIOSH 5506		LFC	480		2000		4		HPLC-UV	F/CST C/HLD	225-1713 225-1	94 102	ST	226-30-04	38	
Chrysosporium species (fungi, molds, spores)	OSHA CSI			120		1000		2		varies	F/CST	225-3-01	90	C/HLD	225-1	102	
Chrysosporium species (fungi, molds, spores)	OSHA CSI			141.5		28300		5 min		varies	BI	225-9611	120				
Chrysotile (see asbestos fibers)	NIOSH 9000			bulk						XRD							
Chrysotile fibers (see asbestos fibers)	NIOSH 7400																
Cladosporium species (fungi, molds, spores)	OSHA CSI			120		1000		2		varies	F/CST	225-3-01	90	C/HLD	225-1	102	
Cladosporium species (fungi, molds, spores)	OSHA CSI			141.5		28300		5 min		varies	BI	225-9611	120				
Clopidol (respirable fraction)	OSHA CSI		5 mg/m ³	varies		varies		varies		HPLC-UV	F/CST CYC	225-706 225-105	96 110	C/HLD	225-1	102	
Clopidol (total dust)	OSHA CSI		15 mg/m ³	120		1000		2		HPLC-UV	F/CST	225-709	96	C/HLD	225-1	102	
Coal dust (< 5% SiO ₂)	OSHA CSI		2.4 mg/m ³ (%SiO ₂ +2)	varies		varies		varies		GR	FLT CYC	225-5-37-P 225-105	93 110	C/HLD CST	225-1 225-3LF	102 97	
Coal dust (> 5% SiO ₂) (see Silica, respirable crystalline)	OSHA ID 142																
Coal tar naphtha (naphthas)	NIOSH 1550		100	3		20		2.5		GC-FID	ST	226-01	38				
Coal tar pitch volatiles	OSHA 58	1076	0.2 mg/m ³	960		2000		8		GR & HPLC-FD, or GR & HPLC-UV	FLT C/HLD	225-7 225-1	96 102	CST	225-2LF	97	
Cobalt	OSHA ID 213		0.1 mg/m ³	480		2000		6		ICP-AES	F/CST	225-3-01	90	C/HLD	225-1	102	
Cobalt & compounds (as Co)	NIOSH 7027		0.05 mg/m ³	960		2000		8		AA-F	F/CST	225-3-01	90	C/HLD	225-1	102	
Cobalt (Elements by Cellulosic Internal Capsule Sampler)	NIOSH 7306		0.05 mg/m ³ (dust, fume)	1-2000		1000-4000		Varies		ICP-AES	SC	225-8517	90	C/HLD	225-1	102	
Cobalt (Elements by ICP Aqua Regia Ashing)	NIOSH 7301		0.5 mg/m ³ (dust, fume)	25-2000		1000-4000		varies		ICP-AES	F/CST C/HLD	225-3-01 225-1	or 102	F/CST	225-803 ¥	93	
Cobalt (Elements by ICP HNO ₃ Digestion)	NIOSH 7303		0.5 mg/m ³ (dust, fume)	3-500,000		1000-4000		varies		ICP-AES	F/CST	225-3-01	90	C/HLD	225-1	102	
Cobalt (Elements by ICP HNO ₃ /HClO ₄ Ashing)	NIOSH 7300	1455	0.05 mg/m ³ (dust, fume)	25-2000		1000-4000		varies		ICP-AES	F/CST	225-3-01	90	C/HLD	225-1	102	
Cobalt (Elements on Wipes)	NIOSH 9102			wipe						ICP-AES	W TMP	225-2414 225-2415	140 140	TMP	225-2403	or	
Cobalt acetate	OSHA ID 125G			480		2000		4		ICP-AES	F/CST F/CST C/HLD	225-3-01 225-803 225-1	or or	F/CST F/CST	225-3100 225-8215	or 93	
Cobalt carbonyl	OSHA ID 121			960		2000		8		AA or AES	F/CST	225-3-01	90	C/HLD	225-1	102	
Cobalt hydrocarbonyl	OSHA ID 121	1193	0.1 mg/m ³ (as Co)	960		2000		8		AA or AES	F/CST	225-3-01	90	C/HLD	225-1	102	

Agency standards for OSHA listings represent the OSHA PELs reported in the 29 CFR 1910.1000 Part 1910, Section 1000.

References and abbreviations are found on pages 212-213.

Chemical Hazard	Agency Reference	Chem F File	SAMPLING ∞								Analytical Method	SKC Collecting Equipment & Page Number			
			Agency Standard		Vol. (liter)		Rate (ml/min)		Time						
			TWA (ppm)	CLG/STEL (ppm)	TWA (Sample Time or Air Volume)	CLG/STEL	TWA (Flow/Sampling Rate)	CLG/STEL	TWA (hrs)	CLG/STEL (min)					
Cobalt metal, dust & fume	OSHA ID 125G		0.1 mg/m ³	480	2000	4		ICP-AES	F/CST 225-3-01 F/CST 225-803 C/HLD 225-1	or or 102	F/CST 225-3100 F/CST 225-8215	or or 93			
Cobalt metal, dust & fume (as Co)	OSHA ID 121	1210	0.1 mg/m ³	960	2000	8		AA or AES	F/CST 225-3-01		90 C/HLD 225-1	102			
Coke oven emissions	OSHA 58		0.15 mg/m ³	960	2000	8		GR & HPLC-FD, or GR & HPLC-UV	FLT 225-7 C/HLD 225-1		96 CST 225-2LF	97			
Command (dimethazone)	OSHA PV2066			60	1000	1		GC-ECD	ST 226-30-16		38				
Copper (Elements by ICP Aqua Regia Ashing)	NIOSH 7301		1 mg/m ³ (dust) 0.1 mg/m ³ (fume)	5-1000	1000-4000	varies		ICP-AES	F/CST 225-3-01 C/HLD 225-1		or 102	F/CST 225-803 ¥	93		
Copper (Elements by ICP HNO ₃ Digestion)	NIOSH 7303		1 mg/m ³ (dust) 0.1 mg/m ³ (fume)	15-500,000	1000-4000	varies		ICP-AES	F/CST 225-3-01		90 C/HLD 225-1	102			
Copper (Elements by ICP HNO ₃ /HClO ₄ Ashing)	NIOSH 7300	1455	1 mg/m ³ (dust) 0.1 mg/m ³ (fume)	5-1000	1000-4000	varies		ICP-AES	F/CST 225-3-01		90 C/HLD 225-1	102			
Copper (Elements on Wipes)	NIOSH 9102		wipe					ICP-AES	W 225-2414 TMP 225-2415		140 TMP 225-2403	or			
Copper dust	NIOSH 7029		1 mg/m ³	480	1000	8		AA-F	F/CST 225-3-01		90 C/HLD 225-1	102			
Copper dusts & mists	OSHA ID 125G		1 mg/m ³	480	2000	4		ICP-AES	F/CST 225-3-01 F/CST 225-803 C/HLD 225-1	or or 102	F/CST 225-3100 F/CST 225-8215	or 93			
Copper dusts & mists (as Cu)	OSHA ID 121	1205	1 mg/m ³	960	2000	8		AA or AES	F/CST 225-3-01		90 C/HLD 225-1	102			
Copper fume	NIOSH 7029		0.1 mg/m ³	480	1000	8		AA-F	F/CST 225-3-01		90 C/HLD 225-1	102			
Copper fume	OSHA ID 121	1206	0.1 mg/m ³	960	2000	8		AA or AES	F/CST 225-3-01		90 C/HLD 225-1	102			
Copper fume	OSHA ID 125G		0.1 mg/m ³	480	2000	4		ICP-AES	F/CST 225-3-01 F/CST 225-803 C/HLD 225-1	or or 102	F/CST 225-3100 F/CST 225-8215	or 93			
Copper fume (ICP analysis of metal/metalloid particulates from solder operations)	OSHA ID 206		0.1 mg/m ³	480	2000	4		ICP-AES	F/CST 225-3-01		90 C/HLD 225-1	102			
Co-Ral (coumaphos)	OSHA CSI			480	1000	8		GC-FPD	ST 226-30-16		38				
Corn starch (see dust, respirable nuisance)															
Coronene	OSHA CSI			960	2000	8		HPLC-UV	F/CST 225-709		96 C/HLD 225-1	102			
Corundum (Al ₂ O ₃) (see alpha-alumina [total dust])															
Corundum (emery) (particulates, respirable)	NIOSH 0600	1038		375	2500	2.5		GR	FLT 225-5-37-P CYC 225-01-02		93 C/HLD 225-1 111 CST 225-3LF	102 97			
Corundum (emery) (particulates, total)	NIOSH 0500	1035		120	2000	1		GR	FLT 225-5-37-P CST 225-2LF		93 C/HLD 225-1	102			
Corynebacterium species (bacteria)	OSHA CSI			141.5	28300	5 min		varies	BI 225-9611		120				
Cotton Dust (raw)	OSHA CSI		1 mg/m ³	960	2	8		GR	FLT 225-5-37-P IS 225-388		with PPI 225-381 or PPI 225-386	and 112			
Cotton Dust (raw)	OSHA CSI		1 mg/m ³	2664	7.4	6		GR	F/CST 225-803		93 ^{VERT. ELUTRATOR}	NA SKC			
Coumarin	OSHA CSI			96	200	8		HPLC-UV	ST 226-30-04		38				
Crag herbicide (respirable dust)	OSHA CSI		5 mg/m ³	varies	varies	varies		CLR	F/CST 225-803 CYC 225-105		93 C/HLD 225-1 110	102			
Crag herbicide (total dust)	OSHA CSI		15 mg/m ³	90	1500	1		CLR	F/CST 225-3-01		90 C/HLD 225-1	102			
p-Cresidine (see 5-methyl-o-anisidine)	OSHA CSI														
di-tert-butyl-p-Cresol	OSHA PV2108			100	1000	100 min		GC-FID	ST 226-57		39				
Cresol (all isomers)	NIOSH 2546		10 mg/m ³	24	100	4		GC-FID	ST 226-95		40				
Cresol (all isomers)	OSHA 32		5 mg/m ³	24	100	4		HPLC-UV	ST 226-95		40				
Cresols	EPA TO-8	1668	< 80 L		100-1000 ml/min			HPLC-UV	IMP 225-36-1		67 IT 225-22	67			
Cresyll acid (see cresol, all isomers)	OSHA CSI														
Cristobalite (see Silica, respirable crystalline)	OSHA ID 142														
Cristobalite (silica, crystalline [respirable] by XRD)	NIOSH 7500	1370	0.05 mg/m ³	400-1000	2500	varies		XRD	F/CST 225-803 C/HLD 225-1		93 CYC 225-01-02 102	111			
Cristobalite (silica, crystalline by IR)	NIOSH 7602		0.05 mg/m ³	400-800	2500	varies		IR	F/CST 225-803 CYC 225-01-02		93 C/HLD 225-1 111	102			
Cristobalite (silica, crystalline by VAS)	NIOSH 7601	1041	0.05 mg/m ³	400-800	2500	varies		VAS	F/CST 225-803 CYC 225-01-02		93 C/HLD 225-1 111	102			
Crocidolite fibers (see asbestos fibers)	NIOSH 7400														
Crotonaldehyde	ASTM D 5197			varies	500-1200	5 min-24 hrs		HPLC-UV	ST 226-120 °		or ST 226-119	40			
Crotonaldehyde	NIOSH 3516		2	48	200	4		DPP	IMP 225-36-2		67 IT 225-22	67			
Crotonaldehyde	OSHA 81		2	6	100	1		HPLC-UV	CF/CST 225-9019		64 C/HLD 225-1	102			
Crotonaldehyde (Aldehydes, Screening)	NIOSH 2539		2	5	20	4		GC-FID & GC-MS	ST 226-118		40				
Crufomate	OSHA PV2015			60	1000	1		GC-FPD	ST 226-30-16		38				
Cryolite (fluorides)	NIOSH 7902		2.5 mg/m ³	480	1000	8		ISE	CF/CST 225-9001		64 C/HLD 225-1	102			

Agency standards for OSHA listings represent the OSHA PELs reported in the 29 CFR 1910.1000 Part 1910, Section 1000.

References and abbreviations are found on pages 212-213.

Sampling Guide

www.skinc.com for updates

Chemical Hazard	Agency Reference	Chem F File	SAMPLING ∞								Analytical Method	SKC Collecting Equipment & Page Number					
			Agency Standard		Vol. (liter)		Rate (ml/min)		Time								
			TWA (ppm)	CLG/STEL (ppm)	TWA (Sample Time or Air Volume)	CLG/STEL	TWA (Flow/Sampling Rate)	CLG/STEL	TWA (hrs)	CLG/STEL (min)							
Cumene (isopropyl benzene)	EPA TO-17	1689			1 L & 4 L		16.7 ml/min & 66.7 ml/min			TD, GC	ST CPC	226-300 Series 224-26-CPC	42 51	TH	224-26-02	51	
Cumene (isopropyl benzene)	OSHA 07	1065	50		10		20(50)		8(3.3)	GC-FID	ST	226-01				38	
Cumene (isopropyl benzene)	OSHA PV2137		50		24		200		2	GC-FID	ST	226-01				38	
Cumene (isopropyl benzene) (Hydrocarbons, Aromatic)	NIOSH 1501		50 (skin)		1-30		10-200		8(3.3)	GC-FID	ST	226-01				38	
Cumene hydroperoxide	OSHA CSI				120		1000		2	HPLC-UV	IMP	225-36-1	67	IT	225-22	67	
Cunninghamella species (fungi, molds, spores)	OSHA CSI				120		1000		2	varies	F/CST	225-3-01	90	C/HLD	225-1	102	
Cunninghamella species (fungi, molds, spores)	OSHA CSI				141.5		28300		5 min	varies	BI	225-9611	120				
Cupric carbonate as Cu (Elements by ICP HNO ₃ /HClO ₄ , Ashing)	NIOSH 7300	1455			960		1000-4000		varies	ICP-AES	F/CST	225-3-01	90	C/HLD	225-1	102	
Curvularia species (fungi, molds, spores)	OSHA CSI				120		1000		2	varies	F/CST	225-3-01	90	C/HLD	225-1	102	
Curvularia species (fungi, molds, spores)	OSHA CSI				141.5		28300		5 min	varies	BI	225-9611	120				
Cyanamide	OSHA CSI				10		100		100 min	HPLC-UV	ST	226-30-18				38	
Cyanazine	NIOSH 5602				480		1000		8	GC-ECD	ST	226-58				39	
Cyanide (as Cn)	OSHA ID 120		5 mg/m ³		120		1000		2	ISE	F/CST IT	225-3-01 225-22	90 67	IMP	225-36-2	67	
Cyanides, aerosol & gas	NIOSH 7904			5 mg/m ³ (10 min)	120		500		4	ISE	FLT IMP C/HLD	225-2705 Δ 225-36-2 225-1	94 67 102	CST IT	225-2LF 225-22	97 67	
Cyanogen	OSHA PV2104				12		200		1	GC-NPD	ST	226-117				40	
Cyanogen chloride	OSHA CSI					1	200		5	GC-NPD	ST	226-117				40	
Cyanuric acid	NIOSH 5030				480		1000		8	HPLC-UV	F/CST	225-802	93	C/HLD	225-1	102	
Cyclohexane	OSHA 07	1134	300		10		20(50)		8(3.3)	GC-FID	ST	226-01				38	
Cyclohexane (hydrocarbons, BP 36 to 216 C)	NIOSH 1500	1268	300		2.5-5		10-200		varies	GC-FID	ST	226-01				38	
Cyclohexanol	OSHA 07	1135	50		10		20(50)		8(3.3)	GC-FID	ST	226-01				38	
Cyclohexanol (alcohols combined)	NIOSH 1405		50 (skin)		1-10		10-200		varies	GC-FID	ST	226-01				38	
Cyclohexanol (alcohols III)	NIOSH 1402		50		10		20(50)		8(3.3)	GC-FID	ST	226-01				38	
Cyclohexanone	EPA TO-17	1689			1 L & 4 L		16.7 ml/min & 66.7 ml/min			TD, GC	ST CPC	226-300 Series 224-26-CPC	42 51	TH	224-26-02	51	
Cyclohexanone	OSHA 01	1073	50		10		20(50)		8(3.3)	GC-FID	ST	226-110				40	
Cyclohexanone (Ketones I)	NIOSH 1300		25		10		20(50)		8(3.3)	GC-FID	ST	226-01				38	
Cyclohexanone (Ketones I)	NIOSH 2555				1-10		10-200		varies	GC-FID	ST	NA SKC					
Cyclohexene	OSHA 07	1124	300		10		20(50)		8(3.3)	GC-FID	ST	226-01				38	
Cyclohexene (hydrocarbons, BP 36 to 216 C)	NIOSH 1500		300		5-7		10-200		varies	GC-FID	ST	226-01				38	
N-Cyclohexyl-2-benzothiazolesulfenamide	OSHA CSI				480		2000		4	HPLC-UV	F/CST	225-709	96	C/HLD	225-1	102	
Cyclohexylamine	OSHA PV2016				20		200		100 min	GC-FID	ST	226-98				40	
Cyclonite (RDX)	OSHA CSI		1.5 mg/m ³ (skin)		120		1000		2	HPLC-UV	F/CST	225-709	96	C/HLD	225-1	102	
Cyclopentane	OSHA CSI				5		200		25 min	GC-FID	ST	226-01				38	
Cyhexatin	OSHA ID 197SG				480		2000		4	AA-GF	F/CST C/HLD	225-709 225-1	96 102	ST	226-30	38	
Cypermethrin	OSHA PV2063				60		1000		60 min	GC-ECD	ST	226-30-16				38	
D & C red #19	OSHA CSI				240		1000		4	HPLC-UV	F/CST	225-709	96	C/HLD	225-1	102	
2,4-D (2,4-dichlorophenoxyacetic acid)	NIOSH 5001		10 mg/m ³		180		1000		3	HPLC-UV	F/CST	225-706	96	C/HLD	225-1	102	
2,4-D (2,4-dichlorophenoxyacetic acid)	OSHA CSI		10 mg/m ³		180		3000		1	HPLC-UV	F/CST	225-709	96	C/HLD	225-1	102	
2,4-D (2-butoxyethyl ester)	NIOSH 5602				480		1000		8	GC-ECD	ST	226-58				39	
2,4-D (2-butoxyethyl ester)	NIOSH 5602				480		1000		8	GC-ECD	ST	226-58				39	
2,4-D acid	NIOSH 5602		10		480		1000		8	GC-ECD	ST	226-58				39	
2,4-D, BE	NIOSH 5602				480		1000		8	GC-ECD	ST	226-58				39	
2,4-D, EH	NIOSH 5602				480		1000		8	GC-ECD	ST	226-58				39	
2,4-D, ME (2,4-dichlorophenoxyacetic acid)	NIOSH 5602				480		1000		8	GC-ECD	ST	226-58				39	
Dacthal	ASTM D 4861				240-7200		1000-5000		4-24	GC-ECD	PUF	226-92				44	
DAP (diallyl phthalate)	OSHA CSI				60		1000		1	GC-FID	ST	226-30-16				38	
DBP (see dibutyl phthalate)	OSHA 104																
p,p-DDE	ASTM D 4861				240-7200		1000-5000		4-24	GC-ECD	PUF	226-92				44	
DDT	OSHA CSI		1 mg/m ³		90		1500		1	GC-ECD	F/CST	225-709	96	C/HLD	225-1	102	
p,p-DDT	ASTM D 4861				240-7200		1000-5000		4-24	GC-ECD	PUF	226-92				44	
DDVP (dichlorvos)	ASTM D 4861				240-7200		1000-5000		4-24	GC-ECD	PUF	226-92				44	
Decaborane	OSHA CSI		0.05		480	30	2000 2000		4 15	ICP	F/CST	225-3-01	90	C/HLD	225-1	102	
Decabromodiphenyl oxide	NIOSH 2559				48-960		2000		varies	HPLC-UV	FLT CST	225-1822 225-2LF	95 97	SP	225-27	103	
Decabromodiphenyl oxide	OSHA CSI				200		1000		3	GC-ECD	F/CST	225-709	96	C/HLD	225-1	102	

Agency standards for OSHA listings represent the OSHA PELs reported in the 29 CFR 1910.1000 Part 1910, Section 1000.

References and abbreviations are found on pages 212-213.

Chemical Hazard	Agency Reference	Chem F File	SAMPLING ∞								Analytical Method	SKC Collecting Equipment & Page Number				
			Agency Standard		Vol. (liter)		Rate (ml/min)		Time							
			TWA (ppm)	CLG/STEL (ppm)	TWA (Sample Time or Air Volume)	CLG/STEL	TWA (Flow/Sampling Rate)	CLG/STEL	TWA (hrs)	CLG/STEL (min)						
n-Decane	EPA TO-17	1689			1 L & 4 L		16.7 ml/min & 66.7 ml/min				TD, GC	ST 226-300 Series CPC	42 TH 224-26-02	51		
n-Decane (hydrocarbons, BP 36 to 216 C)	NIOSH 1500				2		10-50		varies		GC-FID	ST 226-01	38			
Decyl alcohol	OSHA CSI				10		20(50)		8(3.3)		GC-FID	ST 226-01	38			
DEHP (see di-2-ethylhexyl phthalate)	OSHA 104															
Dehydroabietic acid	OSHA CSI				180		2000		1.5		HPLC-UV	F/CST 225-709	96 C/HLD 225-1	102		
Dehydroisandrosterone	OSHA CSI				240		1000		4		HPLC-UV	F/CST 225-709	96 C/HLD 225-1	102		
Demeton	NIOSH 5514		0.1 mg/m ³		480		1000		8		GC-FPD	FLT 225-5 CST 225-2LF C/HLD 225-1	88 SCN 225-26 97 ST 226-30-05	103 38		
Demeton (Systox)	OSHA CSI		0.1 mg/m ³		480		1000		8		GC-FPD	ST 226-30-16	38			
Demosan	OSHA CSI				960		2000		8		GC-ECD	F/CST 225-709	96 C/HLD 225-1	102		
DEP (see diethyl phthalate)	OSHA 104															
Desflurane	OSHA 106	1760			3		50		1		GC-FID	ST 226-81A	39			
Di-(2-ethylhexyl) adipate	OSHA CSI				180		1000		3		GC-FID	FLT 225-17-04 C/HLD 225-1	94 CST 225-3LF	97		
Di-(2-ethylhexyl) phthalate	OSHA CSI		5 mg/m ³		60	15	1000	1000	1	15	GC-FID	ST 226-30-16	38			
Di-(2-ethylhexyl) phthalate (DEHP)	NIOSH 5020				180		1000		3		GC-FID	F/CST 225-3-01	90 C/HLD 225-1	102		
Di(ethyleneglycol) ethyl ether acrylate	OSHA PV2132		1 mg/m ³		48		200		4		GC-FID	ST 226-110	40			
Diacetone alcohol	OSHA 07	1123	50		10		20(50)		8(3.3)		GC-FID	ST 226-01	38			
Diacetone alcohol (alcohols combined)	NIOSH 1405		50		1-10		10-200		varies		GC-FID	ST 226-01	38			
Diacetone alcohol (alcohols III)	NIOSH 1402		50		10		20(50)		8(3.3)		GC-FID	ST 226-01	38			
Diacetyl	NIOSH 2557				6		100		1		GC	ST NA SKC				
Diacetyl	OSHA 1012		0.05		9	3	50	200	3	15	GC-FID	ST 226-183	41			
Diacetyl	OSHA 1013		0.05		9	3	50	200	3	15	GC-FID	ST 226-183	41			
Diallyl disulfide	OSHA PV2086				10		20(50)		8(3.3)		GC-FPD	ST 226-110	40			
Diallyl phthalate	OSHA CSI				60		1000		1		GC-FID	ST 226-30-16	38			
1,2-Diaminoethane	NIOSH 2540				10		100		1.7		HPLC-UV	ST 226-30-18	38			
o-Dianisidine	OSHA 71	1235			100		1000		100 min		GC-ECD	CF/CST 225-9004	64 C/HLD 225-1	102		
o-Dianisidine dyes (dyes, benzidine)	NIOSH 5013		LFC		480		1000		8		HPLC-UV	FLT 225-17A C/HLD 225-1	94 CST 225-3LF	97		
o-Dianisidine-based dyes	OSHA CSI				480		1000		8		HPLC-UV	FLT 225-17-04 C/HLD 225-1	94 CST 225-3LF	97		
Diazinon ASTM D 4861					240-7200		1000-5000		4-24		GC-NPD	PUF 226-92	44			
Diazinon OSHA 62	1396				480		1000		8		GC-FPD	ST 226-30-16	38			
Diazinon (Organophosphorus Pesticides)	NIOSH 5600		0.1 mg/m ³		240		1000		4		GC-FPD	ST 226-58	39			
Diazomethane	NIOSH 2515		0.2		10		200		50 min		GC-FID	ST 226-23	38			
Diazomethane	OSHA CSI		0.2		10		200		50 min		GC-FID	ST 226-23	38			
Dibenz(a,h)anthracene	OSHA CSI				960		2000		8		HPLC-UV	F/CST 225-709	96 C/HLD 225-1	102		
Dibenz(a,h)anthracene (Polynuclear Aromatic Hydrocarbons by GC-MS)	ASTM D 6209				350 m ³ (max)		225 L/min		1-24		GC-MS	PUF 226-131	45 FLT 225-1808	95		
Dibenz(a,h)anthracene (Polynuclear Aromatic Hydrocarbons by GC)	NIOSH 5515				480		2000		4		GC-FID	F/CST 225-1713 C/HLD 225-1	94 ST 226-30-04	38		
Dibenz(a,h)anthracene (Polynuclear Aromatic Hydrocarbons by HPLC)	NIOSH 5506				480		2000		4		HPLC-FD	F/CST 225-1713 C/HLD 225-1	94 ST 226-30-04	38		
Diborane	NIOSH 6006		0.1		120		1000		2		PES	ST 226-151 CST 225-32	41 FLT NA SKC	and		
Dibrom	OSHA CSI		3 mg/m ³		60		1000		1		GC-FPD	ST 226-30-16	38			
1,2-Dibromo-3-chloropropane (DBCP)	OSHA CSI		1 ppb		10		20(50)		8(3.3)		GC-ECD	ST 226-81A	39			
Dibromodifluoromethane (difluorodibromomethane)	NIOSH 1012		100		10		20(50)		8(3.3)		GC-FID	ST 226-01	38			
1,2-Dibromoethane (ethylene dibromide)	ASTM D 5466				6		varies		varies		GC-MS	CAN 228 Series	PK 228 Series			
1,2-Dibromoethane (ethylene dibromide)	NIOSH 1008		0.045	0.13	24	3	50	200	8	15	GC-ECD	ST 226-01	38			
Dibutyl amine	OSHA CSI				120		1000		2		GC-NPD	IMP 225-36-2	67 IT 225-22	67		
2-Dibutyl aminoethanol (aminoethanol compounds I)	NIOSH 2007		2		10		20(50)		8(3.3)		GC-FID	ST 226-10-04	38			
Dibutyl phosphate	NIOSH 5017		1	2	240		2000		2		GC-FPD	FLT 225-17-01 C/HLD 225-1	94 CST 225-2LF	97		
Dibutyl phthalate	NIOSH 5020		5 mg/m ³		100		1000		100 min		GC-FID	F/CST 225-3-01	90 C/HLD 225-1	102		
Dibutyl phthalate (DBP)	OSHA 104		5 mg/m ³		240		1000		4		GC-FID	ST 226-56	39			
Dibutyltin bis (isooctyl mercaptoacetate) (organotin compounds as Sn)	NIOSH 5504		0.1 mg/m ³		480		1000		8		HPLC & AA-GF	ST 226-30 C/HLD 225-1	38 F/CST 225-709	96		
Dibutyltin dilaurate (as Sn)	OSHA ID 218SG				500		1000		500 min		AA	F/CST 225-3-01	90 C/HLD 225-1	102		
Dibutyltin maleate (as Sn)	OSHA ID 224SG				200		1000		200 min		AA-GF	F/CST 225-3-01	90 C/HLD 225-1	102		
Dicamba	OSHA CSI				200		1000		3.3		HPLC-UV	F/CST 225-709	96 C/HLD 225-1	102		

Agency standards for OSHA listings represent the OSHA PELs reported in the 29 CFR 1910.1000 Part 1910, Section 1000.

References and abbreviations are found on pages 212-213.

Sampling Guide

www.skcinc.com for updates

D

Chemical Hazard	Agency Reference	Chem F File	SAMPLING ∞								Analytical Method	SKC Collecting Equipment & Page Number				
			Agency Standard		Vol. (liter)		Rate (ml/min)		Time							
			TWA (ppm)	CLG/STEL (ppm)	TWA	CLG/STEL Sample Time or Air Volume	TWA	CLG/STEL Flow/Sampling Rate	TWA (hrs)	CLG/STEL (min)						
Dicamba sodium salt	OSHA CSI			200		1000		3.3		HPLC-UV	F/CST	225-709	96	C/HLD	225-1	102
3,3-Dichloro-1,1,1,2,2-pentafluoropropane	OSHA CSI			9		50		3		GC-FID	ST	226-01		38		
2,2-Dichloro-1,1,1-trifluoroethane	NON 50			9		50		3		GC-FID	ST	226-09		38		
1,3-Dichloro-1,1,2,2,3-pentafluoropropane	OSHA CSI			9		50		3		GC-FID	ST	226-01		38		
1,1-Dichloro-1-fluoroethane	OSHA 113			1		50		20 min		GC-FID	ST	NA SKC				
1,1-Dichloro-1-nitroethane	NIOSH 1601		2	10		20(50)		8(3.3)		GC-FID	ST	226-81A		39		
1,1-Dichloro-1-nitroethane	OSHA 07			10	15		1000		15	GC-FID	ST	226-81A		39		
1,1-Dichloro-1-nitroethane	OSHA CSI			10	10	20		8		GC-FID	ST	226-81A		39		
Dichloroacetylene	OSHA CSI				1		200		5	GC-FID	ST	226-01		38		
3,4-Dichloroaniline	OSHA CSI			100		1000		1.5		HPLC	F/CST	225-803	93	C/HLD	225-1	102
m-Dichlorobenzene	ASTM D 5466			6		varies		varies		GC-MS	CAN	228 Series		PK	228 Series	
m-Dichlorobenzene	OSHA CSI			10		200		50 min		GC-FID	ST	226-01		38		
o-Dichlorobenzene	ASTM D 5466			6		varies		varies		GC-MS	CAN	228 Series		PK	228 Series	
o-Dichlorobenzene	OSHA 07	1122		50 (C)	3		200		15	GC-FID	ST	226-01		38		
p-Dichlorobenzene	ASTM D 5466			6		varies		varies		GC-MS	CAN	228 Series		PK	228 Series	
p-Dichlorobenzene	OSHA 07	1121	75	3	0.75	20	50	2.5	15	GC-FID	ST	226-01		38		
o-Dichlorobenzene (hydrocarbons, halogenated)	NIOSH 1003			50	3		10-200		varies	GC-FID	ST	226-01		38		
p-Dichlorobenzene (hydrocarbons, halogenated)	NIOSH 1003			1.7 (LOQ)	3		10-200		varies	GC-FID	ST	226-01		38		
3,3'-Dichlorobenzidine	OSHA 65	1238		100		1000		100 min		GC-ECD	CF/CST	225-9004	64	C/HLD	225-1	102
Dichlorodifluoroethane	OSHA CSI			3		100		30 min		GC-FID	ST	226-01		38		
Dichlorodifluoromethane	NIOSH 1018		1000	3		20		2.5		GC-FID	ST	226-01	38	ST	226-09	38
1,2-Dichloroethane	EPA TO-17	1689		1 L & 4 L		16.7 ml/min & 66.7 ml/min				TD, GC	ST CPC	226-300 Series 224-26-CPC	42 51	TH	224-26-02	51
1,2-Dichloroethane (ethylene dichloride)	OSHA 07	1119	50	100	10		20(50)		8(3.3)	GC-FID	ST	226-01		38		
1,1-Dichloroethane (ethylidene chloride)	ASTM D 5466			6		varies		varies		GC-MS	CAN	228 Series		PK	228 Series	
1,1-Dichloroethane (ethylidene chloride)	OSHA 07		100	10		20(50)		8(3.3)		GC-FID	ST	226-01		38		
1,1-Dichloroethane (Hydrocarbons, Halogenated)	NIOSH 1003	1267	100	10		10-200		varies		GC-FID	ST	226-01		38		
Dichloroethyl ether	NIOSH 1004		5	10	10		20(50)		8(3.3)	GC-FID	ST	226-01		38		
Dichloroethyl ether	OSHA 07			15	10	15	20	1000	8	15	GC-FID	ST	226-01		38	
1,2-Dichloroethylene	OSHA 07	1118	200	3		20		2.5		GC-FID	ST	226-01		38		
cis-1,2-Dichloroethylene	ASTM D 5466			6		varies		varies		GC-MS	CAN	228 Series		PK	228 Series	
1,2-Dichloroethylene (hydrocarbons, halogenated)	NIOSH 1003		200	3		10-200		varies		GC-FID	ST	226-01		38		
Dichlorofluoromethane	NIOSH 2516		10	3		20		2.5		GC-FID	ST	226-25		38		
Dichloromethane	ASTM D 5466			6		varies		varies		GC-MS	CAN	228 Series		PK	228 Series	
Dichloromethane (methylene chloride)	EPA TO-17	1689		1 L & 4 L		16.7 ml/min & 66.7 ml/min				TD, GC	ST CPC	226-300 Series 224-26-CPC	42 51	TH	224-26-02	51
Dichloromethane (see methylene chloride)																
Dichloromonofluoromethane (dichlorofluoromethane)	NIOSH 2516		10	3		20		2		GC-FID	ST	226-09		38		
Dichloromonofluoromethane (dichlorofluoromethane)	OSHA CSI		1000	3		20		2.5		GC-FID	ST	226-09		38		
2,4-Dichlorophenoxyacetic acid (2,4-D)	NIOSH 5001		10 mg/m ³	180		1000		3		HPLC-UV	F/CST	225-709	96	C/HLD	225-1	102
1,2-Dichloropropane (propylene dichloride)	ASTM D 5466			6		varies		varies		GC-MS	CAN	228 Series		PK	228 Series	
1,2-Dichloropropane (propylene dichloride)	NIOSH 1013		LFC	3		20		2.5		GC-ECN	ST	226-81A		39		
1,3-Dichloropropene	OSHA CSI			5		200		25 min		GC-FID	ST	226-01		38		
cis-1,3-Dichloropropene	ASTM D 5466			6		varies		varies		GC-MS	CAN	228 Series		PK	228 Series	
trans-1,3-Dichloropropene	ASTM D 5466			6		varies		varies		GC-MS	CAN	228 Series		PK	228 Series	
3,4-Dichloropropionanilide	OSHA CSI									W	FLT	225-7		96		
2,2-Dichloropropionic acid	OSHA PV2017			10		200		50 min		HPLC-UV	ST	226-10		38		
Dichlorotetrafluoroethane	OSHA CSI			3		50		1		GC-FID	ST	226-09	38	ST	226-01	38
1,1-Dichlorotetrafluoroethane	OSHA CSI			2		50		40 min		GC-FID	ST	226-01	38	ST	226-09	38
1,2-Dichlorotetrafluoroethane (dichlorodifluoromethane)	NIOSH 1018		1000	3		20		2.5		GC-FID	ST	226-01	38	ST	226-09	38
Dichlorotrifluoroethane	NON 50			9		50		3		GC-FID	ST	226-09		38		
Dichlorvos (DDVP)	ASTM D 4861			240-7200		1000-5000		4-24		GC-ECD	PUF	226-92		44		
Dichlorvos (DDVP)	OSHA 62	1395	1 mg/m ³	480		1000		8		GC-FPD	ST	226-30-16		38		
Dicloran	ASTM D 4861			240-7200		1000-5000		4-24		GC-ECD	PUF	226-92		44		
Dicofol	ASTM D 4861			240-7200		1000-5000		4-24		GC-ECD	PUF	226-92		44		
Dicofol	OSHA CSI									W	SM TB	225-24		140		
Dicrotophos	ASTM D 4861			240-7200		1000-5000		4-24		HPLC-UV	PUF	226-92		44		
Dicrotophos (Bidrin)	OSHA PV2099			480		1000		8		GC-FPD	ST	226-30-16		38		

Agency standards for OSHA listings represent the OSHA PELs reported in the 29 CFR 1910.1000 Part 1910, Section 1000.

References and abbreviations are found on pages 212-213.

Chemical Hazard	Agency Reference	Chem F File	SAMPLING ∞								Analytical Method	SKC Collecting Equipment & Page Number				
			Agency Standard		Vol. (liter)		Rate (ml/min)		Time							
			TWA (ppm)	CLG/STEL (ppm)	TWA (Sample Time or Air Volume)	CLG/STEL	TWA (Flow/Sampling Rate)	CLG/STEL	TWA (hrs)	CLG/STEL (min)						
Dicrotophos (Organophosphorus Pesticides)	NIOSH 5600		0.25 mg/m ³		240		1000		4	GC-FPD	ST	226-58	39			
Dicyclopentadiene	OSHA PV2098				10		100		100 min	GC-FID	ST	226-01	38			
Dicyclopentadienyl iron (respirable dust)	OSHA CSI		5 mg/m ³		varies		varies		varies	GR	F/CST	225-803	93	C/HLD 225-1	102	
Dicyclopentadienyl iron (total dust)	OSHA CSI		15 mg/m ³		960		2000		8	AA	F/CST	225-3-01	90	C/HLD 225-1	102	
Dieldrin	ASTM D 4861				240-7200		1000-5000		4-24	GC-ECD	PUF	226-92	44			
Dieldrin	OSHA CSI		0.25 mg/m ³		180		1500		2	GC-ECD	F/CST	225-709	96	C/HLD 225-1	102	
Diesel emissions (see elemental carbon)	NIOSH 5040									TOA-FID						
Diesel exhaust particles (see elemental carbon)	NIOSH 5040									TOA-FID						
Diesel particulate matter	ASTM D 6877				varies		1000-4000		varies	EGA-TOS	DPM	225-317	or	F/CST 225-401	95	
Diesel particulate matter	MSHA 30CFR57		350 µg/m ³ (total carbon)		varies		2000		varies	TOA-FID	DPM	225-317	95	CYC 225-105	110	
Diesel particulate matter	MSHA 30CFR57		350 µg/m ³ (total carbon)		varies		varies		varies	TOA-FID	F/CST	225-401	95	CYC 225-100	110	
Diethanolamine	OSHA PV2018				10		100		100 min	HPLC-UV	ST	226-30-18	38			
Diethanolamine (DEA) (Aminoethanol Compounds II)	NIOSH 3509	1006	3		240		1000		4	IC	IMP	225-36-1	67	IT 225-22	67	
Diethyl ether (ethyl ether)	NIOSH 1610				0.25-3		10-200		varies	GC-FID	ST	226-01	38			
Diethyl ketone (3-pentanone)	OSHA CSI				10		20(50)		8(3.3)	GC-FID	ST	NA SKC				
Diethyl phthalate (DEP)	OSHA 104				240		1000		4	GC-FID	ST	226-56	39			
Diethyl sulfate	OSHA CSI				15		1000		15 min	GC-FID	ST	226-10	38			
Diethylamine	OSHA 41	1697	25		10	3	200	200	50 min	15	HPLC	ST	226-96	40		
Diethylamine (amines, aliphatic)	NIOSH 2010		10	25	24	3	50	200	8	15	GC-FID	ST	226-10	38		
2-Diethylaminoethanol	OSHA CSI		10		24		200		2		GC-FID	ST	226-10-04	38		
2-Diethylaminoethanol (aminoethanol compounds I)	NIOSH 2007		10		10		20(50)		8(3.3)		GC-FID	ST	226-10-04	38		
Diethylaminopropylamine (DEP)	OSHA CSI				100		1000		100 min		GC-NPD	IMP	225-36-1	67	IT 225-22	67
Diethylene dioxide (see dioxane)																
Diethylene ether (see dioxane)																
Diethylene glycol (glycols)	NIOSH 5523	1387			60		1000		1		GC-FID	ST	226-57	39		
Diethylene glycol methyl ether	OSHA CSI				10		100		100 min		GC-FID	ST	226-01	38		
Diethylene glycol monobutyl ether acetate	OSHA CSI				9.6		100		1.6		GC-FID	ST	226-01	38		
Diethylene glycol monoethyl ether	OSHA CSI				10		20(50)		8(3.3)		GC-FID	ST	226-01	38		
Diethylenetriamine	OSHA 60	1285			10		100		100 min		HPLC-UV	ST	226-30-18	38		
Difluorodibromomethane	NIOSH 1012		100		6		50		2		GC-FID	ST	226-01	38		
Difluorodibromomethane	OSHA 07		100		10		20		8		GC-FID	ST	226-01	38		
Diglycidyl ether of bisphenol A	OSHA 1018				240		1000		240 (min)		HPLC-UV/PDA	F/CST	225-709	96	C/HLD 225-1	102
Diglycolamine	OSHA CSI				20		100		3		GC-NPD	IMP	225-36-1	67	IT 225-22	67
Diglyme	OSHA CSI				20		200		100 min		GC-FID	ST	226-01	38		
Dihexyl phthalate	OSHA PV2076				240		1000		4		GC-FID	ST	226-56	39		
Dihydrocapsaicin	NIOSH 5041				480	15	1000	1000	8	15	HPLC-FD	FLT	225-16	96	CST 225-32	102
Diisobutyl ketone	OSHA 07	1116	50		10		20(50)		8(3.3)		GC-FID	ST	226-01	38		
Diisobutyl ketone (Ketones I)	NIOSH 1300		25		10		20(50)		8(3.3)		GC-FID	ST	226-01	38		
Diisobutyl ketone (Ketones I)	NIOSH 2555				1-10		10-200		varies		GC-FID	ST	NA SKC			
Diisocyanates	OSHA 42	1458			240	15	1000	1000	4	15	HPLC-UV or HPLC-FD	CF/CST	225-9002	or	CF/CST 225-9013	64
Diisopropylamine	OSHA CSI		5		120		1000		2		GC-FID	IMP	225-36-1	67	IT 225-22	67
Dimethazone	OSHA PV2066				60		1000		1		GC-ECD	ST	226-30-16	38		
Dimethoate	OSHA PV2113				480		1000		8		GC-FPD	ST	226-30-16	38		
2,5-Dimethoxyaniline	OSHA CSI				17		50		5.7		HPLC-UV	ST	226-30-04	38		
Dimethoxymethane (methylal)	NIOSH 1611		1000		2		20		1.5		GC-FID	ST	226-01	38		
Dimethoxymethane (methylal)	OSHA 07	1115	1000		2		20		1.5		GC-FID	ST	226-01	38		
Dimethyl adipate	OSHA PV2019				20		200		100 min		GC-FID	ST	226-01	38		
Dimethyl arsenic acid (arsenic, organo-)	NIOSH 5022				960		2000		8		IC-AA	FLT	225-17-01	94	CST 225-2LF	97
Dimethyl disulfide	NON 42	1413			12		1000		12 min		GC-FPD	SB	253-10	or	SB 263-10	or
Dimethyl disulfide	OSHA CSI				6		100		1		GC-FID	ST	226-01	38		
Dimethyl glutarate	OSHA PV2020				20		200		100 min		GC-FID	ST	226-01	38		
Dimethyl phthalate (DMP)	OSHA 104		5 mg/m ³		240		1000		4		GC-FID	ST	226-56	39		
Dimethyl succinate	OSHA PV2021				20		200		100 min		GC-FID	ST	226-01	38		
Dimethyl sulfate	NIOSH 2524	1284	0.1 (8 hrs.)		12		50		4		GC-ECN	ST	226-114	40		
Dimethyl sulfate	OSHA PV2147		1		10		100		100 min		GC-FPD	ST	226-115	40		

D

Agency standards for OSHA listings represent the OSHA PELs reported in the 29 CFR 1910.1000 Part 1910, Section 1000.

References and abbreviations are found on pages 212-213.

Sampling Guide

www.skinc.com for updates

D

Chemical Hazard	Agency Reference	Chem F File	SAMPLING ∞								Analytical Method	SKC Collecting Equipment & Page Number				
			Agency Standard		Vol. (liter)		Rate (ml/min)		Time							
			TWA (ppm)	CLG/STEL (ppm)	TWA	CLG/STEL	TWA	CLG/STEL	TWA (hrs)	CLG/STEL (min)						
Dimethyl sulfide	NON 42	1413			12			1000			12 min		GC-FPD	SB 263-10	or SB 231-10	54
Dimethyl sulfide	OSHA CSI				5			20			4		GC-FPD	ST 226-01		38
Dimethyl sulfoxide	OSHA CSI				10			100			100 min		GC-FID	ST 226-01		38
Dimethyl-1,2-dibromo-2,2-dichloroethyl phosphate	OSHA CSI		3 mg/m ³		60			1000			1		GC-FPD	ST 226-30-16		38
2,3-Dimethyl-2,3-dinitrobutane	NON 44		0.15 mg/m ³ OEL		10			200			50 min		GC-ECD	ST 226-35-03		39
Dimethylacetamide	NIOSH 2004	1695	10		48			100			8		GC-FID	ST 226-10		38
Dimethylacetamide	OSHA CSI		10		60			1000			1		GC-FID	ST 226-10		38
Dimethylamine	NIOSH 2010		10		24			50			8		GC-FID	ST 226-10		38
Dimethylamine	OSHA 34	1696	10		10			20			8		HPLC	ST 226-96		40
2-Dimethylamino ethanol	NIOSH 2561				10-24			20-100			varies		GC-FID	ST 226-94		40
1-Dimethylamino-2-propanol	NIOSH 2561				10-24			20-100			varies		GC-FID	ST 226-94		40
4-Dimethylaminoazobenzene	OSHA CSI				60			1000			1		HPLC-UV	F/CST 225-706	96 C/HLD 225-1	102
													IMP	225-36-1	67 IT 225-22	67
Dimethylaminobenzene	OSHA CSI		5		24			50			8		GC-FID	ST 226-10		38
2,4-Dimethylaminobenzene (Amines, Aromatic)	NIOSH 2002		2		24			50			8		GC-FID or GC-NSD	ST 226-10		38
N,N-Dimethylaniline	OSHA 07		5		10	3		20(50)	200		8(3.3)	15	GC-FID	ST 226-01		38
N,N-Dimethylaniline	OSHA PV2064		5		30			200			2.5		GC-FID	ST 226-98		40
N,N-Dimethylaniline (Amines, Aromatic)	NIOSH 2002	1054	5	10	24	3		50	200		8	15	GC-FID or GC-NSD	ST 226-10		38
2,5-Dimethylbenzaldehyde	ASTM D 5197				varies			500-1200			5 min-24 hrs		HPLC-UV	ST 226-120 °	or ST 226-119	40
trans-1,4-Dimethylcyclohexane	OSHA CSI				10			20(50)			8(3.3)		GC-FID	ST 226-01		38
N,N-Dimethylethanolamine	NIOSH 2561				10-24			20-100			varies		GC-FID	ST 226-94		40
N,N-Dimethylethanolamine	OSHA CSI				24			50			8		GC-FID	ST 226-10-04		38
N,N-Dimethylethylamine	OSHA PV2096				40			100			40 min		GC-NPD	ST 226-18		38
N,N-Dimethylformamide	NIOSH 2004		10		24			50			8		GC-FID	ST 226-10		38
N,N-Dimethylformamide	OSHA 66	1271	10		9.6	3		20	200		8	15	GC-NPD	ST 226-01		38
1,1-Dimethylhydrazine	NIOSH 3515		0.06 (120 min)		60			1000			1		VAS	IMP 225-36-2	67 IT 225-22	67
1,1-Dimethylhydrazine	OSHA CSI		0.5		96			200			8		CLR	IMP 225-36-2	67 IT 225-22	67
N,N-Dimethyl-p-toluidine (Amines, Aromatic)	NIOSH 2002	1055			96			200			8		GC-FID or GC-NSD	ST 226-10		38
Dimethyltin dichloride	NIOSH 5526		0.1 mg/m ³		60	60		250	1000		4	60	GC-FPD	ST 226-30-16		38
Di-n-hexyl phthalate	OSHA PV2076				240			1000			4		GC-FID	ST 226-56		39
Dinitolmide	OSHA CSI				240			1000			4		HPLC	F/CST 225-706	96 C/HLD 225-1	102
Dinitrobenzene (all isomers)	OSHA CSI		1 mg/m ³		60			1000			1		HPLC-UV	ST 226-30-16		38
Dinitro-o-cresol	OSHA CSI		0.2 mg/m ³		180			1500			2		HPLC-UV	F/CST 225-3-01	90 IMP 225-36-1	67
													IT	225-22		
4,6-Dinitro-o-sec-butyl phenol	OSHA CSI				24			50			8		HPLC-UV	ST 226-95		40
2-(2,4-Dinitrophenoxy)ethanol	OSHA CSI				10			20(50)			8(3.3)		HPLC-UV	ST 226-10		38
Dinitrotoluene (DNT)	OSHA 44		1.5 mg/m ³		60			1000			1		GC-TEA	ST 226-56		39
Di-n-octyl phthalate (DNOP)	OSHA 104				240			1000			4		GC-FID	ST 226-56		39
Di-n-octyl-phthalate (DNOP)	OSHA CSI				90			1000			1.5		GC-ECD	ST 226-56		39
n-Dioctyl phthalate (DNOP)	OSHA 104				240			1000			4		GC-FID	ST 226-56		39
Dioxane (diethylene dioxide)	NIOSH 1602		1 (30 min)		10			20(50)			8(3.3)		GC-FID	ST 226-01		38
Dioxane (diethylene dioxide)	OSHA 07	1114	100		10			20(50)			8(3.3)		GC-FID	ST 226-01		38
Dioxathion (Delnav)	OSHA CSI				480			1000			8		GC-FPD	ST 226-30-16		38
Dioxin (including, PHDDs, PCDDs, PBDDs)	EPA TO-9A	1673						200-280 L/min			24 hrs		HRGC-HRMS	PUF 226-131	41 FLT 225-1808	95
Diphenyl	NIOSH 2530		0.2		30			100			5		GC-FID	ST 226-35-01		38
Diphenyl ether	OSHA PV2022		0.2		20			200			100 min		GC-FID	ST 226-95		40
p,p-Diphenyl methane diisocyanate (MDI) (see methylene bisphenyl isocyanate)	OSHA 47															
2-Diphenylacetyl-1,3-indandione	OSHA CSI				480			2000			4		HPLC-UV	F/CST 225-706	96 C/HLD 225-1	102
Diphenylamine	OSHA 78	1229			100			1000			100 min		HPLC-UV	CF/CST 225-9004	64 C/HLD 225-1	102
5,5-Diphenylhydantoin	OSHA CSI				60			1000			1		HPLC-UV	FLT 225-7 †	96 CST 225-3LF	97
													C/HLD	225-1	102	
Diphenylmethane-4,4'-diisocyanate (4,4-methylene bisphenyl isocyanate) (isocyanates)	NIOSH 5521	1001	50 µg/m ³	200 µg/m ³ (10 min) C	480	10		1000	1000		8	10	HPLC-ELCHM & HPLC-UV	IMP 225-36-1	67 IT 225-22	67
Dipropyl disulfide	OSHA PV2086				10			20(50)			8(3.3)		GC-FPD	ST 226-110		40
Dipropyl ketone	OSHA CSI				10			20			8		GC-FID	ST NA SKC		
Dipropylene glycol methyl ether	OSHA 07	1113	100		10	3		20(50)	200		8(3.3)	15	GC-FID	ST 226-01		38
Dipropylene glycol methyl ether	OSHA 101		100		10			100			100 min		GC-FID	ST 226-01		38

Agency standards for OSHA listings represent the OSHA PELs reported in the 29 CFR 1910.1000 Part 1910, Section 1000.

References and abbreviations are found on pages 212-213.

Chemical Hazard	Agency Reference	Chem F File	SAMPLING ∞								Analytical Method	SKC Collecting Equipment & Page Number				
			Agency Standard		Vol. (liter)		Rate (ml/min)		Time							
			TWA (ppm)	CLG/STEL (ppm)	TWA (Sample Time or Air Volume)	CLG/STEL	TWA (Flow/Sampling Rate)	CLG/STEL	TWA (hrs)	CLG/STEL (min)						
Dipropylene glycol methyl ether (glycol ethers)	NIOSH 2554				3-25		100-200			varies	GC-FID	ST	226-81A	39		
Dipropylene glycol monomethyl ether (glycol ethers)	NIOSH 2554				3-25		100-200			varies	GC-FID	ST	226-81A	39		
Diquat	OSHA CSI				120		1000			2	HPLC-UV	F/CST	225-709	96	C/HLD 225-1	102
Direct black 38	OSHA CSI				100		1000			100 min	HPLC	F/CST	225-706	96	C/HLD 225-1	102
Direct black 38 (dyes, benzidine)	NIOSH 5013		LFC		480		1000			8	HPLC	FLT C/HLD	225-17A 225-1	94	CST 225-3LF	97
Direct blue	OSHA CSI				60		1000			1	HPLC-UV	F/CST	225-709	96	C/HLD 225-1	102
Direct blue 2	OSHA CSI				100		1000			100 min	HPLC-UV	F/CST	225-709	96	C/HLD 225-1	102
Direct blue 6	OSHA CSI				100		1000			100 min	HPLC-UV	F/CST	225-709	96	C/HLD 225-1	102
Direct blue 6 (dyes, benzidine)	NIOSH 5013		LFC		480		1000			8	HPLC	FLT C/HLD	225-17A 225-1	94	CST 225-3LF	97
Direct blue 8 (dyes, benzidine)	NIOSH 5013		LFC		480		1000			8	HPLC	FLT C/HLD	225-17A 225-1	94	CST 225-3LF	97
Direct blue 98	OSHA CSI				180		1000			3	HPLC-UV	F/CST	225-706	96	C/HLD 225-1	102
Direct brown 31	OSHA CSI				180		1000			3	HPLC-UV	F/CST	225-706	96	C/HLD 225-1	102
Direct brown 95	OSHA CSI				100		1000			100 min	HPLC-UV	F/CST	225-709	96	C/HLD 225-1	102
Direct brown 95 (dyes, benzidine)	NIOSH 5013		LFC		480		1000			8	HPLC	FLT C/HLD	225-17A 225-1	94	CST 225-3LF	97
Direct red 2	OSHA CSI				120		1000			2	HPLC-UV	F/CST	225-709	96	C/HLD 225-1	102
Direct red 2 (dyes, benzidine)	NIOSH 5013		LFC		480		1000			8	HPLC	FLT C/HLD	225-17A 225-1	94	CST 225-3LF	97
Direct red 28 (dyes, benzidine)	NIOSH 5013		LFC		480		1000			8	HPLC	FLT C/HLD	225-17A 225-1	94	CST 225-3LF	97
Direct red 81	OSHA CSI				100		1000			100	HPLC-UV	F/CST	225-709	96	C/HLD 225-1	102
Di-sec-octyl phthalate (see di-[2-ethylhexyl] phthalate)																
Disperse yellow 3	OSHA CSI				100		1000			100 min	HPLC-UV	F/CST	225-709	96	C/HLD 225-1	102
Disulfiram (tetraethylthiuram disulfide)	OSHA CSI				120		1000			2	HPLC-UV	F/CST	225-709	96	C/HLD 225-1	102
Disulfoton	OSHA PV2105				480		1000			8	GC-FPD	ST	226-30-16	38		
Disulfoton (Organophosphorus Pesticides)	NIOSH 5600		0.1 mg/m ³		240		1000			4	GC-FPD	ST	226-58	39		
Disyston	OSHA CSI				480		1000			8	GC-FPD	ST	226-30-16	38		
2,2'-Dithiobis(benzothiazole)	OSHA CSI				480		2000			4	HPLC-UV	F/CST	225-706	96	C/HLD 225-1	102
Diuron	ASTM D 4861				240-7200		1000-5000			4-24	HPLC-UV	PUF	226-92	44		
Diuron (Organonitrogen Pesticides)	NIOSH 5601		10 mg/m ³		240		1000			4	HPLC-UV	ST	226-58	or	ST 226-30-16	38
Divinyl benzene	OSHA 89				12		50			4	GC-FID	ST	226-73	39		
Divinyl sulfide	OSHA CSI				2.5		20			2	GC	ST	226-01	38		
DMP (see dimethyl phthalate)	OSHA 104															
DNOP (see di-n-octyl phthalate)	OSHA 104															
DNT (dinitrotoluene)	OSHA 44		1.5 mg/m ³		60		1000			1	GC-TEA	ST	226-56	39		
n-Dodecane	EPA TO-17	1689			1 L & 4 L		16.7 ml/min & 66.7 ml/min				TD, GC	ST CPC	226-300 Series 224-26-CPC	42	TH 224-26-02	51
Dodecyl alcohol (lauryl alcohol)	OSHA CSI				10		20(50)			8(3.3)	GC-FID	ST	226-01	38		
Dodine	OSHA CSI				240		1000			2	HPLC-UV	ST	226-30	38		
Dursban (chlorpyrifos)(organophosphorus pesticides)	NIOSH 5600		0.2 mg/m ³ 0.6 mg/m ³		240		1000			4	GC-FPD	ST	226-58	39		
Dust, inorganic					15-150		15000			1-10 min	varies	STC	225-9820	101		
Dust, respirable (in workplace atmospheres)	ASTM D 4532	1418			varies		2500			varies	GR	FLT CYC	225-5-37-P 225-01-02	93	C/HLD 225-1	102
Dust, respirable nuisance	OSHA CSI		5.0 mg/m ³		varies		varies			varies	GR	FLT CYC	225-5-37-P 225-105	93	C/HLD 225-1	102
Dust, respirable nuisance (particulates)	NIOSH 0600	1038			375		2500			2.5	GR	FLT CYC	225-5-37-P 225-01-02	93	C/HLD 225-1	102
Dust, total nuisance	OSHA CSI		15 mg/m ³		720		1500			8	GR	FLT CST	225-5-37-P 225-2LF	93	C/HLD 225-1	102
Dust, total nuisance (particulates)	NIOSH 0500	1035			120		2000			1	GR	FLT CST	225-5-37-P 225-2LF	93	C/HLD 225-1	102
Dust, total, particulates not otherwise regulated	NIOSH 0500	1035			120		2000			1	GR	FLT CST	225-5-37-P 225-2LF	93	C/HLD 225-1	102
Dyes, benzidine, o-tolidine, o-dianisidine	NIOSH 5013		LFC		480		1000			8	HPLC-UV	FLT C/HLD	225-17A 225-1	94	CST 225-3LF	97
Dyfonate	OSHA CSI				480		1000			8	GC-FPD	ST	226-30-16	38		
Elemental carbon (diesel exhaust)	MSHA				varies		varies			varies	EGA-TOS	DPM	225-317	95	CYC 225-105	110
Elemental carbon (diesel exhaust)	NIOSH 5040				varies		varies			varies	TOA-FID	F/CST C/HLD	225-401 225-1	95	CYC 225-100	110
Elements by Cellulosic Internal Capsule Sampler (see specific element)	NIOSH 7306		Varies		Varies		1000-4000			Varies	ICP-AES	SC	225-8517	90	C/HLD 225-1	102

D

Agency standards for OSHA listings represent the OSHA PELs reported in the 29 CFR 1910.1000 Part 1910, Section 1000.

References and abbreviations are found on pages 212-213.

Sampling Guide

www.skinc.com for updates

E	Chemical Hazard	Agency Reference	Chem F File	SAMPLING ∞								Analytical Method	SKC Collecting Equipment & Page Number					
				Agency Standard		Vol. (liter)		Rate (ml/min)		Time								
				TWA	CLG/STEL (ppm)	TWA	CLG/STEL	TWA	CLG/STEL	TWA	CLG/STEL							
	Elements by ICP Aqua Regia ashing (see specific element)	NIOSH 7301		varies		varies		1000-4000		varies	ICP-AES	F/CST	225-3-01	or	F/CST	225-803	93	
	Elements by ICP HNO ₃ digestion (see specific element)	NIOSH 7303		varies		varies		1000-4000		varies	ICP-AES	F/CST	225-3-01	90	C/HLD	225-1	102	
	Elements by ICP HNO ₃ /HClO ₄ ashing (see specific element)	NIOSH 7300	1455	varies		varies		1000-4000		varies	ICP-AES	F/CST	225-3-01	90	C/HLD	225-1	102	
	Elements on wipes (see specific element)	NIOSH 9102				wipe					ICP-AES	W TMP	225-2414 225-2415	140 140	TMP	225-2403	or	
	Elements qualitative	OSHA ID 204				480		2000		8	XRF	F/CST	225-3-01	90	C/HLD	225-1	102	
	Emery (corundum) (particulates, respirable)	NIOSH 0600	1038			375		2500		2.5	GR	FLT CYC	225-5-37-P 225-01-02	93 111	C/HLD CST	225-1 225-3LF	102 97	
	Emery (corundum) (particulates, total)	NIOSH 0500	1035			120		2000		1	GR	FLT CST	225-5-37-P 225-2LF	93 97	C/HLD	225-1	102	
	Emery (respirable dust)	OSHA CSI		5 mg/m ³		varies		varies		varies	GR	FLT CYC	225-5-37-P 225-105	93 110	C/HLD CST	225-1 225-3LF	102 97	
	Emery (total dust)	OSHA CSI		15 mg/m ³		960		2000		8	GR	F/CST	225-803	93	C/HLD	225-1	102	
	Endosulfan (thiodan)	OSHA PV2023				60		1000		1	GC-ECD	ST	226-30-16	38				
	Endotoxins (bacteria in air)	NON 48				62.5-375		12500 +		5-30	varies	BS	225-9595	122	VT	225-9598A	122	
	Endrin	NIOSH 5519		0.1 mg/m ³		240		1000		4	GC-ECD	CST SCN C/HLD	225-2LF 225-26 225-1	97 103 102	FLT ST	225-5 NA SKC	88	
	Enflurane (ethrane)	OSHA 103	1348			12		50		4	GC-FID	ST	226-81A	39				
	Enflurane (ethrane)	OSHA 29				10		20		8	GC-FID	ST	226-01	38				
	Environmental tobacco smoke (nicotine & 3-ethenylpyridine)	NON 49				90-720		1500		1-8	GC-NSD	ST	226-170	41				
	Environmental tobacco smoke (respirable particles)	ASTM D 5955	1419			varies		varies		varies	GR & HPLC-UV & HPLC-FD	FLT CYC	225-2705 225-01-02	94 111	C/HLD CST	225-1 225-3LF	102 97	
	Environmental tobacco smoke (solanesol, respirable particles)	ASTM D 6271				150-3600		2500		1-24	HPLC-UV	FLT CYC	225-2705 225-01-02	94 111	CST C/HLD	225-3LF 225-1	97 102	
	Epichlorohydrin	NIOSH 1010		LFC		10	3	20(50)	200	8(3.3)	15	GC-FID	ST	226-01	38			
	Epichlorohydrin	OSHA 07	1112	5		20		100		3.3	GC-FID	ST	226-01	38				
	Epicoccum species (fungi, molds, spores)	OSHA CSI				120		1000		2	varies	F/CST	225-3-01	90	C/HLD	225-1	102	
	Epicoccum species (fungi, molds, spores)	OSHA CSI				141.5		28300		5 min	varies	BI	225-9611	120				
	EPN	NIOSH 5012		0.5 mg/m ³		480		1000		8	GC-FFD	F/CST	225-709	96	C/HLD	225-1	102	
	EPN	OSHA CSI		0.5 mg/m ³		480		1000		8	GC-FFD	ST	226-30-16	38				
	1,2-Epoxyethylbenzene	OSHA CSI				10		20(50)		8(3.3)	GC-FID	ST	226-35	38				
	1,2-Epoxypropane (see propylene oxide)																	
	2,4,D-Esters	ASTM D 4861				240-7200		1000-5000		4-24	GC-ECD	PUF	226-92	44				
	Esters I (see specific compounds)	NIOSH 1450		varies		1-10		varies		varies	GC-FID	ST	226-01	38				
	Estradiol	OSHA PV2001				240		1000		4	HPLC-UV	F/CST	225-706	96	C/HLD	225-1	102	
	Estrilol	OSHA PV2001				60		1000		1	HPLC-UV	F/CST	225-706	96	C/HLD	225-1	102	
	Estrone	OSHA PV2001				60		1000		1	HPLC-UV	F/CST	225-706	96	C/HLD	225-1	102	
	1,2-Ethanedilol (ethylene glycol) (glycols)	NIOSH 5523	1401			24		100		4	GC-FID	ST	226-57	39				
	1,2-Ethanedilol dinitrate	OSHA 43				0.2 (C)		15		1000		15	HPLC-TEA	ST	226-35-03	39		
	2-(2-methoxyethoxy)Ethanol	OSHA CSI				6		100		1	GC-FID	ST	226-01	38				
	Ethanol (ethyl alcohol)	EPA TO-17	1689			1 L & 4 L		16.7 ml/min & 66.7 ml/min				TD, GC	ST CPC	226-300 Series 224-26-CPC	42 51	TH	224-26-02	51
	Ethanolamine	OSHA PV2111	3			10	1.5	100	100	100 min	15	HPLC-UV	ST	226-30-18	38			
	3-Ethenylpyridine	NON 49				90-720		1500		1-8	GC-NSD	ST	226-170	41				
	3-Ethenylpyridine & nicotine	ASTM D 5075	1427			90-2160		1500		1-24	GC-NPD	ST	226-93	40				
	Ethion (nialate)	OSHA CSI				480		1000		8	GC-FFD	ST	226-30-16	38				
	Ethion (Organophosphorus Pesticides)	NIOSH 5600		0.4 mg/m ³		240		1000		4	GC-FFD	ST	226-58	39				
	Ethoprop (Organophosphorus Pesticides)	NIOSH 5600				240		1000		4	GC-FFD	ST	226-58	39				
	1-Ethoxy-2-propanol	OSHA CSI				48		100		8	GC-FID	ST	226-01	38				
	2-Ethoxyethanol	EPA TO-17	1689			1 L & 4 L		16.7 ml/min & 66.7 ml/min				TD, GC	ST CPC	226-300 Series 224-26-CPC	42 51	TH	224-26-02	51
	2-Ethoxyethanol (alcohols IV)	NIOSH 1403	1273	0.5 (skin)		1-6		10-50		varies	GC-FID	ST	226-01	38				
	2-Ethoxyethanol (CELLOSOLVE solvent)	OSHA 79	1277	200		48	15	100	1000	8	15	GC-FID	ST	226-01	38			
	2-Ethoxyethanol (CELLOSOLVE solvent) (alcohols IV)	NIOSH 1403	1273	0.5 (skin)		1-6		10-50		varies	GC-FID	ST	226-01	38				
	2-Ethoxyethyl acetate	EPA TO-17	1689			1 L & 4 L		16.7 ml/min & 66.7 ml/min				TD, GC	ST CPC	226-300 Series 224-26-CPC	42 51	TH	224-26-02	51
	2-Ethoxyethyl acetate (CELLOSOLVE acetate)	OSHA 79	1277	100		48	15	100	1000	8	15	GC-FID	ST	226-01	38			
	2-Ethoxyethyl acetate (Esters I)	NIOSH 1450		0.5 (skin)		1-10		10-200		varies	GC-FID	ST	226-01	38				

Agency standards for OSHA listings represent the OSHA PELs reported in the 29 CFR 1910.1000 Part 1910, Section 1000.

References and abbreviations are found on pages 212-213.

Chemical Hazard	Agency Reference	Chem F File	SAMPLING ∞								Analytical Method	SKC Collecting Equipment & Page Number				
			Agency Standard		Vol. (liter)		Rate (ml/min)		Time							
			TWA (ppm)	CLG/STEL (ppm)	TWA (Sample Time or Air Volume)	CLG/STEL	TWA (Flow/Sampling Rate)	CLG/STEL	TWA (hrs)	CLG/STEL (min)						
Ethrane (enflurane)	OSHA 29				10		100			1.6		GC-FID	ST	226-01	38	
Ethyl 2-cyanoacrylate	OSHA 55				12		100			2		HPLC-UV	ST	226-98	40	
Ethyl acetate	EPA TO-17	1689			1 L & 4 L		16.7 ml/min & 66.7 ml/min					TD, GC	ST CPC	226-300 Series 224-26-CPC	42 TH 51	224-26-02 51
Ethyl acetate	NIOSH 1457		400		10		20			8		GC-FID	ST	226-01	38	
Ethyl acetate	OSHA 07	1111	400		5		20			4		GC-FID	ST	226-01	38	
Ethyl acrylate	EPA TO-17	1689			1 L & 4 L		16.7 ml/min & 66.7 ml/min					TD, GC	ST CPC	226-300 Series 224-26-CPC	42 TH 51	224-26-02 51
Ethyl acrylate	NON 54		5	15	10	3	20	200		8	15	GC-FID	ST	226-81A	39	
Ethyl acrylate	OSHA 92		25		12	0.75	50	50		4	15	GC-FID	ST	226-73	39	
Ethyl acrylate (Esters I)	NIOSH 1450		4 (LOQ)		1-10		10-200			varies		GC-FID	ST	226-01	38	
Ethyl alcohol (ethanol)	EPA TO-17	1689			1 L & 4 L		16.7 ml/min & 66.7 ml/min					TD, GC	ST CPC	226-300 Series 224-26-CPC	42 TH 51	224-26-02 51
Ethyl alcohol (ethanol)	OSHA 07	1109	1000		1		50			20 min		GC-FID	ST	226-01	38	
Ethyl alcohol (ethanol)	OSHA 100	1283	1000		12		50			4		GC-FID	ST	226-82	40	
Ethyl alcohol (ethanol) (Alcohols I)	NIOSH 1400		1000		1		50			20 min		GC-FID	ST	226-01	38	
Ethyl amyl ketone	OSHA 07	1158	25		10		20(50)			8(3.3)		GC-FID	ST	226-01	38	
Ethyl benzene	ASTM D 5466				6		varies			varies		GC-MS	CAN	228 Series	PK	228 Series
Ethyl benzene	EPA TO-17	1689			1 L & 4 L		16.7 ml/min & 66.7 ml/min					TD, GC	ST CPC	226-300 Series 224-26-CPC	42 TH 51	224-26-02 51
Ethyl benzene	OSHA 07	1108	100		10	3	20(50)	200		8(3.3)	15	GC-FID	ST	226-01	38	
Ethyl benzene	OSHA 1002	1746	100		12		50			4		GC-FID	ST	226-01	38	
Ethyl benzene	OSHA 1002	1746	100				13.83			8		GC-FID	PS	575-002	75	
Ethyl benzene (Hydrocarbons, Aromatic)	NIOSH 1501	1053	100	125	1-24	1-24	10-200	10-200		varies	varies	GC-FID	ST	226-01	38	
Ethyl bromide (bromoethane)	NIOSH 1011				4		20			3.3		GC-FID	ST	226-01	38	
Ethyl bromide (bromoethane)	OSHA 07	1107	200		5	3	20	200		4	15	GC-FID	ST	226-01	38	
Ethyl butyl ketone (3-heptanone)	OSHA 07	1106	50		10		20(50)			8(3.3)		GC-FID	ST	226-01	38	
Ethyl butyl ketone (3-heptanone) (Ketones I)	NIOSH 2553		50		1-25		10-200			varies		GC-FID	ST	NA SKC		
Ethyl butyl ketone (3-heptanone) (Ketones II)	NIOSH 1301		50		24		200			2		GC-FID	ST	226-01	38	
Ethyl chloride	ASTM D 5466				6		varies			varies		GC-MS	CAN	228 Series	PK	228 Series
Ethyl chloride	NIOSH 2519				3		50			1		GC-FID	ST	226-25	38	
Ethyl chloride	OSHA 07		1000		3		50			1		GC-FID	ST	226-01	38	
Ethyl ether (diethyl ether)	OSHA 07	1105	400		3	3	20	200		2.5	15	GC-FID	ST	226-01	38	
Ethyl ether (ethyl ether)	NIOSH 1610				0.25-3		10-200			varies		GC-FID	ST	226-01	38	
Ethyl formate	NIOSH 1452		100		10		20			8		GC-FID	ST	226-01	38	
Ethyl formate	OSHA 07	1104	100		10		20(50)			8(3.3)		GC-FID	ST	226-01	38	
Ethyl lactate	OSHA PV2081				10		200			50 min		GC-FID	ST	226-01	38	
Ethyl mercaptan	OSHA CSI			10 (C)			120			1000	120	GC-FPD	CF/CST	225-9007	64 C/HLD	225-1 102
Ethyl mercaptan (mercaptans)	NIOSH 2542	1330		0.5 (15 min)	48	12	100	200		8	60	GC-FPD	CF/CST	225-9007	64 C/HLD	225-1 102
Ethyl methacrylate	NIOSH 2537				1-8		10-50			varies		GC-FID	ST	226-30-06	38	
Ethyl methacrylate	OSHA PV2100				10		20(50)			8(3.3)		GC-FID	ST	226-01	38	
Ethyl O-(p-nitrophenyl) phenylphosphonothionate (EPN)	NIOSH 5012		0.5 mg/m ³		480		1000			8		GC-FPD	F/CST	225-709	96 C/HLD	225-1 102
Ethyl parathion	ASTM D 4861				240-7200		1000-5000			4-24		GC-NPD	PUF	226-92	44	
Ethyl propionate	OSHA CSI				10		20(50)			8(3.3)		GC	ST	226-01	38	
Ethyl silicate	OSHA CSI		100		9		50			3		GC-FID	ST	226-30-04	38	
2-Ethyl toluene	EPA TO-17	1689			1 L & 4 L		16.7 ml/min & 66.7 ml/min					TD, GC	ST CPC	226-300 Series 224-26-CPC	42 TH 51	224-26-02 51
3-Ethyl toluene	EPA TO-17	1689			1 L & 4 L		16.7 ml/min & 66.7 ml/min					TD, GC	ST CPC	226-300 Series 224-26-CPC	42 TH 51	224-26-02 51
4-Ethyl toluene	EPA TO-17	1689			1 L & 4 L		16.7 ml/min & 66.7 ml/min					TD, GC	ST CPC	226-300 Series 224-26-CPC	42 TH 51	224-26-02 51
Ethyl vinyl benzene	OSHA 89				12		50			4		GC-FID	ST	226-73	39	
Ethyl-3-ethoxypropionate	OSHA PV2025				10		100			100 min		GC-FID	ST	226-01	38	
Ethylamine	OSHA 36		10		10		200			50 min		HPLC-UV	ST	226-96	40	
Ethylene chlorohydrin	NIOSH 2513			1	10	3	20(50)	200		8(3.3)	15	GC-FID	ST	226-81A	39	
Ethylene chlorohydrin	OSHA 07	1159	5		20		40			8		GC-FID	ST	226-81A	39	
Ethylene dibromide (1,2-dibromoethane)	NIOSH 1008		0.045	0.13 (15 min)	10	3	20(50)	200		8(3.3)	15	GC-ECD	ST	226-01	38	
Ethylene dibromide (1,2-dibromoethane)	OSHA 02	1072	20	30	10	1	20(50)	200		8(3.3)	5	GC-ECD	ST	226-01	38	
Ethylene dichloride	EPA TO-17	1689			1 L & 4 L		16.7 ml/min & 66.7 ml/min					TD, GC	ST CPC	226-300 Series 224-26-CPC	42 TH 51	224-26-02 51
Ethylene dichloride (1,2-dichloroethane)	OSHA 03	1063	50	100	10	3	200	200		1	15	GC-ECD	ST	226-01GWS	38	

Agency standards for OSHA listings represent the OSHA PELs reported in the 29 CFR 1910.1000 Part 1910, Section 1000.

References and abbreviations are found on pages 212-213.

Sampling Guide

www.skcinc.com for updates

E	Chemical Hazard	Agency Reference	Chem F File	SAMPLING ∞								Analytical Method	SKC Collecting Equipment & Page Number					
				Agency Standard		Vol. (liter)		Rate (ml/min)		Time								
				TWA (ppm)	CLG/STEL (ppm)	TWA (Sample Time or Air Volume)	CLG/STEL	TWA (Flow/Sampling Rate)	CLG/STEL	TWA (hrs)	CLG/STEL (min)							
	Ethylene dichloride (1,2-dichloroethane) (hydrocarbons, halogenated)	NIOSH 1003		1	2	3	3	10-200	10-200	varies	varies	GC-FID	ST	226-01	38			
	Ethylene glycol (glycols)	NIOSH 5523	1401			60		1000		1		GC-FID	ST	226-57	39			
	Ethylene glycol dinitrate	OSHA 43			0.2 (C)		15		1000		15	HPLC-TEA	ST	226-35-03	39			
	Ethylene glycol dinitrate (nitroglycerine)	NIOSH 2507			0.1 mg/m ³		15		1000		15	GC-ECD	ST	226-35-03	39			
	Ethylene glycol isopropyl ether (isopropyl CELLOSOLVE solvent)	OSHA CSI				9		100		1.5		GC-FID	ST	226-01	38			
	Ethylene glycol monoethyl ether	OSHA CSI				10		200		50 min		GC-FID	ST	226-01	38			
	Ethylene oxide	ASTM D 4413				6	3	100	200	1	15	GC-FID	ST	226-16	or	ST	226-36	39
	Ethylene oxide	ASTM D 5578				9.6	1.5	20	100	8	15	GC-ECD	ST	226-178	41			
	Ethylene oxide	NIOSH 1614		0.1	5 (10 min)	24	1.5	100	150	4	10	GC-ECD	ST	226-178	41			
	Ethylene oxide	OSHA 1010	1751	1	5.0 EL	12	0.75	50	50	4	15	GC-ECD	ST	226-178	41			
	Ethylene oxide (by portable GC)	NIOSH 3702	1031	0.1	5 (10 min)	varies	varies	20-4000	varies	varies	varies	P GC-PID	SB	232 Series	55			
	Ethylene oxide (Qazi-Ketcham)	NON 14				10		20(50)		8(3.3)		GC	ST	226-36	39			
	Ethylene thiourea	NIOSH 5011		LFC		480		2000		4		VAS	F/CST	225-802	93	C/HLD	225-1	102
	Ethylene thiourea	OSHA 95				480		2000		4		HPLC-UV	F/CST	225-706	96	C/HLD	225-1	102
	Ethylenediamine	NIOSH 2540		10		10		100		1.7		HPLC-UV	ST	226-30-18	38			
	Ethylenediamine	OSHA 60	1287	10		10		100		100 min		HPLC-UV	ST	226-30-18	38			
	Ethylenimine	NIOSH 3514				48		200		4		HPLC-UV	IMP	225-36-2	67	IT	225-22	67
	2-Ethylhexanol	OSHA CSI				48		200		4		GC-FID	ST	226-01	38			
	Ethylhexyl acetate	OSHA CSI				10		20(50)		8(3.3)		GC-FID	ST	226-01	38			
	2-Ethylhexyl acrylate	OSHA PV2026				12		100		2		GC-FID	ST	226-73	39			
	di-2-Ethylhexyl phthalate (DEHP)	OSHA 104		5 mg/m ³		240		1000		4		GC-FID	ST	226-56	39			
	N-Ethylmorpholine	OSHA CSI		20		10		20(50)		8(3.3)		GC-FID	ST	226-10	38			
	ETS (see environmental tobacco smoke)	NON 49																
	Exserohilum species (fungi, molds, spores)	OSHA CSI				120		1000		2		varies	F/CST	225-3-01	90	C/HLD	225-1	102
	Exserohilum species (fungi, molds, spores)	OSHA CSI				141.5		28300		5 min		varies	BI	225-9611	120			
	Fenamiphos	OSHA CSI				480		1000		8		GC-FFD	ST	226-30-16	38			
	Fenamiphos (Organophosphorus Pesticides)	NIOSH 5600		0.1 mg/m ³		240		1000		4		GC-FFD	ST	226-58	39			
	Fenarimol	OSHA CSI				30		1000		30 min		HPLC-UV	ST	226-30-16	38			
	Fensulfotion (Dansanit)	OSHA CSI				480		1000		8		GC-FFD	ST	226-30-16	38			
	Fenthion	OSHA CSI				480		1000		8		GC-FFD	ST	226-30-16	38			
	Fenvalerate	ASTM D 4861				240-7200		1000-5000		4-24		HPLC-UV	PUF	226-92	44			
	Ferbam	OSHA CSI		15 mg/m ³		480		1000		8		HPLC-UV	ST	226-30-16	38			
	Ferric chloride (see iron salts, soluble as Fe)	OSHA ID 121																
	Ferovanadium dust	OSHA ID 125G	1218	1 mg/m ³		480	30	2000	2000	4	15	ICP-AES	F/CST	225-3-01	or	F/CST	225-3100	or
												F/CST	225-803	or	F/CST	225-8215	or	93
												C/HLD	225-1	102				
	Fibers (bioaerosols)					15-150		15000		1-10 min		varies	STC	225-9820	101			
	Fibers (see specific compounds)																	
	Fibrous glass (particulates, respirable)	NIOSH 0600	1038			375		2500		2.5		GR	FLT	225-5-37-P	93	C/HLD	225-1	102
													CYC	225-01-02	111	CST	225-3LF	97
	Fibrous glass (particulates, total)	NIOSH 0500	1035			120		2000		1		GR	FLT	225-5-37-P	93	C/HLD	225-1	102
													CST	225-2LF	97			
	Fibrous glass dust	OSHA CSI		15 mg/m ³		960		2000		8		GR	F/CST	225-8204	93	C/HLD	225-1	102
	Flax dust (see dust, total and respirable nuisance)	OSHA CSI																
	Fluoboric acid	OSHA CSI				120		1000		2		ISE	IMP	225-36-2	67	IT	225-22	67
	Fluometuron	ASTM D 4861				240-7200		1000-5000		4-24		HPLC-UV	PUF	226-92	44			
	Fluoranthene	OSHA CSI				960		2000		8		HPLC-UV	F/CST	225-706	96	C/HLD	225-1	102
	Fluoranthene (Polynuclear Aromatic Hydrocarbons by GC-MS)	ASTM D 6209				350 m ³ (max)		225 L/min		1-24		GC-MS	PUF	226-131	45	FLT	225-1808	95
	Fluoranthene (Polynuclear Aromatic Hydrocarbons by GC)	NIOSH 5515				480		2000		4		GC-FID	F/CST	225-1713	94	ST	226-30-04	38
												C/HLD	225-1	102				
	Fluoranthene (Polynuclear Aromatic Hydrocarbons by HPLC)	NIOSH 5506				480		2000		4		HPLC-FD	F/CST	225-1713	94	ST	226-30-04	38
												C/HLD	225-1	102				
	Fluorene	OSHA CSI				960		2000		8		HPLC-UV	F/CST	225-709	96	C/HLD	225-1	102
	Fluorene (Polynuclear Aromatic Hydrocarbons by GC-MS)	ASTM D 6209				350 m ³ (max)		225 L/min		1-24		GC-MS	PUF	226-131	45	FLT	225-1808	95
	Fluorene (Polynuclear Aromatic Hydrocarbons by GC)	NIOSH 5515				480		2000		4		GC-FID	F/CST	225-1713	94	ST	226-30-04	38
												C/HLD	225-1	102				
	Fluorene (Polynuclear Aromatic Hydrocarbons by HPLC)	NIOSH 5506				480		2000		4		HPLC-UV	F/CST	225-1713	94	ST	226-30-04	38
												C/HLD	225-1	102				
	Fluoride (particulate)	NIOSH 7906		2.5 mg/m ³		960		2000		8		IC-CD	CF/CST	225-9031	64	C/HLD	225-1	102

Agency standards for OSHA listings represent the OSHA PELs reported in the 29 CFR 1910.1000 Part 1910, Section 1000.

References and abbreviations are found on pages 212-213.

Chemical Hazard	Agency Reference	Chem F File	SAMPLING ∞								Analytical Method	SKC Collecting Equipment & Page Number							
			Agency Standard		Vol. (liter)		Rate (ml/min)		Time										
			TWA (ppm)	CLG/STEL (ppm)	TWA	CLG/STEL	TWA	CLG/STEL	TWA (hrs)	CLG/STEL (min)									
Fluorides	ASTM D 4765	1421			varies			2000			varies		ISE	CF/CST	225-9001	64	C/HLD	225-1	102
Fluorides (aerosol & gas by ISE)	NIOSH 7902	1226	2.5 mg/m ³	6 (HF)	480	22.5	1000	1500	8	15			ISE	CF/CST	225-9001	64	C/HLD	225-1	102
Fluorides (as F)	OSHA ID 110	1227	2.5 mg/m ³		90	22.5	1500	1500	1	15			ISE	CF/CST	225-9001	64	C/HLD	225-1	102
Fluorine	OSHA CSI		0.1		480		1000		8				ISE	IMP	225-36-2	67	IT	225-22	67
Fluorotrichloromethane (trichlorofluoromethane)	NIOSH 1006			1000		5		20		240			GC-FID	ST	226-09				
5-Fluorouracil	OSHA CSI				180		1000		3				HPLC-UV	ST	226-30-16				
Folpet	ASTM D 4861				240-7200		1000-5000		4-24				GC-ECD	PUF	226-92				
Fonofos (Dyfonate)	OSHA PV2027				480		1000		8				GC-FPD	ST	226-30-16				
Fonofos (Organophosphorus Pesticides)	NIOSH 5600		0.1 mg/m ³		240		1000		4				GC-FPD	ST	226-58				
Formaldehyde	ASTM D 5197	1442			varies		500-1200		5 min-24 hrs				HPLC-UV	ST	226-120 °	or	ST	226-119	40
Formaldehyde	EPA IP-6A	1664					100-1000 ml/min		5 min-24 hrs				HPLC-UV	ST	226-119	or	ST	226-120	40
Formaldehyde	EPA IP-6C	1664					20.4 ml/min		15 min-8 hrs				HPLC-UV	PS	500-100				84
Formaldehyde	EPA IP-6C	1664					20.4 ml/min		1-7 days				HPLC-UV	PS	500-100				84
Formaldehyde	EPA IP-6C	1664					20.4 ml/min		7 days				HPLC-UV	PS	500-100				84
Formaldehyde	EPA TO-11A	1082			varies		100-2000 ml/min		varies				HPLC-UV	ST	226-119	or	ST	226-120	40
Formaldehyde	EPA TO-11A	1082					28.6 ml/min		15 min-24 hrs				HPLC-UV	PS	500-100				84
Formaldehyde	EPA TO-11A	1082					28.6 ml/min		15 min-8 hrs				HPLC-UV	PS	500-100				84
Formaldehyde	EPA TO-11A	1082					28.6 ml/min		7 days				HPLC-UV	PS	500-100				84
Formaldehyde	NIOSH 2016	1761	0.016	0.1 (C)	1-<15	1-<15	30-500	30-500	varies	varies			HPLC-UV	ST	226-119 ♣				40
Formaldehyde	NIOSH 2541	1015	0.016	0.1 (C)	24	1	100	100	4	10			GC-FID	ST	226-118				40
Formaldehyde	NIOSH 3500		0.016	0.1	96	15	200	1000	8	15			VAS	IMP	225-36-1	67	IT	225-22	67
													FLT	225-1709**	94	CST	225-2LF**	97	
													SCN	225-26**	103				
Formaldehyde	OSHA 1007		0.75	2	13.8	0.43	28.6	28.6	8	15			HPLC-UV	PS	500-100				84
Formaldehyde	OSHA 52	1020	0.75	2	24	3	100	200	4	15			GC-NPD	ST	226-117	or	ST	226-54	39
Formaldehyde (Aldehydes, Screening)	NIOSH 2539		0.016	0.1	5		20		4				GC-FID & GC-MS	ST	226-118				40
Formaldehyde on dust (textile or wood)	NIOSH 5700		0.016	0.1	240		2000		4				HPLC-UV	IOM	225-70A	108	FLT	225-5-25	93
Formamide	OSHA CSI				10	1.5	100	100	100 min				GC-NPD	ST	226-10				38
Formetanate (Organonitrogen Pesticides)	NIOSH 5601				240		1000		4				HPLC-UV	ST	226-58	or	ST	226-30-16	38
Formic acid	NIOSH 2011		5		24		200		2				IC-CD	FLT	225-2708	94	CST	225-3-25LF	97
													ST	226-10-03	38	C/HLD	225-1	102	
Formic acid	OSHA ID 186SG		5		48		100		8				IC	ST	226-09				38
Freon 11	ASTM D 5466				6		varies		varies				GC-MS	CAN	228 Series		PK	228 Series	
Freon 113	OSHA 113	1000			1		50		20 min				GC-FID	ST	NA SKC				
Freon 113 (1,1,2-Trichloro-1,2,2-trifluoroethane)	ASTM D 5466				6		varies		varies				GC-MS	CAN	228 Series		PK	228 Series	
Freon 114	ASTM D 5466				6		varies		varies				GC-MS	CAN	228 Series		PK	228 Series	
Freon 12	ASTM D 5466				6		varies		varies				GC-MS	CAN	228 Series		PK	228 Series	
Freon 123	NON 50				9		50		3				GC-FID	ST	226-09				38
Freon 141b	OSHA 113	1000			1		50		20 min				GC-FID	ST	NA SKC				
Fumaric acid	OSHA CSI				180		1000		3				HPLC-UV	F/CST	225-706	96	C/HLD	225-1	102
Fungi	NIOSH 0800				varies		28300		varies				varies	BI	225-9611				120
Fungi (in air)					15-150		15000		1-10 min				varies	STC	225-9820				101
Fungi (in air) (BioSampler method)	NON 48				62.5-375		12500 +		5-30				varies	BS	225-9595	122	VT	225-9598A ◊	122
Furans (including PHDFs, PCDFs, PBDFs)	EPA TO-9A	1673					200-280 L/min		24 hrs				HRGC-HRMS	PUF	226-131	41	FLT	225-1808	95
Furfural	EPA TO-17	1689			1 L & 4 L		16.7 ml/min & 66.7 ml/min						TD, GC	ST	226-300 Series	42	TH	224-26-02	51
													CPC	224-26-CPC	51				
Furfural	NIOSH 2529				5		20		4				GC-FID	ST	226-118				40
Furfural	OSHA 72	5			180		1000		3				GC-FID	ST	226-81A				39
Furfural (Aldehydes, Screening)	NIOSH 2539				5		20		4				GC-FID & GC-MS	ST	226-118				40
Furfuryl alcohol	NIOSH 2505		10	15	5		20		4				GC-FID	ST	226-115				40
Fusarium species (fungi, molds, spores)	OSHA CSI				120		1000		2				varies	F/CST	225-3-01	90	C/HLD	225-1	102
Fusarium species (fungi, molds, spores)	OSHA CSI				141.5		28300		5 min				varies	BI	225-9611				120
Gallium	OSHA CSI				960		2000		8				GR	FLT	225-5-37-P	93	C/HLD	225-1	102
													CST	225-2LF	97				
Gallium (Elements by ICP HNO ₃ Digestion)	NIOSH 7303				1-3300		1000-4000		varies				ICP-AES	F/CST	225-3-01	90	C/HLD	225-1	102
Gasoline	OSHA PV2028				10	1.5	20(50)	100	8(3.3)	15			GC-FID	ST	226-01				38
Gentian violet	OSHA CSI				180		1000		3				HPLC-UV	FLT	225-7	96	CST	225-2LF	97
Germanium oxide	OSHA CSI				960		2000		8				AA-GF	F/CST	225-3-01	90	C/HLD	225-1	102
Glass, fibrous (see asbestos fibers)	NIOSH 7400																		

F

Agency standards for OSHA listings represent the OSHA PELs reported in the 29 CFR 1910.1000 Part 1910, Section 1000.

References and abbreviations are found on pages 212-213.

Sampling Guide

www.skinc.com for updates

G	Chemical Hazard	Agency Reference	Chem F File	SAMPLING ∞								Analytical Method	SKC Collecting Equipment & Page Number				
				Agency Standard		Vol. (liter)		Rate (ml/min)		Time							
				TWA	CLG/STEL (ppm)	TWA	CLG/STEL	TWA	CLG/STEL	TWA	CLG/STEL						
	Glass, fibrous dust	OSHA CSI			960		2000		8		GR	FLT CST	225-5-37-P 225-2LF	93 97	C/HLD	225-1	102
	Gliocladium species (fungi, molds, spores)	OSHA CSI			120		1000		2		varies	F/CST	225-3-01	90	C/HLD	225-1	102
	Gliocladium species (fungi, molds, spores)	OSHA CSI			141.5		28300		5 min		varies	BI	225-9611	120			
	Glutaraldehyde	NIOSH 2531			0.2	4	200	20			HPLC-UV	ST	226-118	40			
	Glutaraldehyde	NIOSH 2532	1346		0.2	3	200	15			HPLC-UV	ST	226-119	40			
	Glutaraldehyde	NON 43			30	15	250	1000	2	15	GC-FID	ST	226-10	38			
	Glutaraldehyde	OSHA 64	1241			15	1000	15			HPLC-UV	CF/CST	225-9003	64	C/HLD	225-1	102
	Glycerin mist (particulates, respirable)	NIOSH 0600	1038		375		2500		2.5		GR	FLT CYC	225-5-37-P 225-01-02	93 111	C/HLD CST	225-1 225-3LF	102 97
	Glycerin mist (respirable)	OSHA CSI		5 mg/m ³	varies		varies		varies		GR	FLT CYC	225-5-37-P 225-105	93 110	C/HLD CST	225-1 225-3LF	102 97
	Glycerin mist (total dust)	OSHA CSI		15 mg/m ³	96		2000		8		GR	F/CST	225-803	93	C/HLD	225-1	102
	Glycidol (2,3-epoxy-1-propanol)	NIOSH 1608		25	10		20(50)		8(3.3)		GC-FID	ST	226-01	38			
	Glycidol (2,3-epoxy-1-propanol)	OSHA 07	1157	50	48		100(200)		8(4)		GC-FID	ST	226-01	38			
	Glycol chlorohydrin (see ethylene chlorohydrin)																
	Glycol ethers	NIOSH 2554			3-25		100-200		varies		GC-FID	ST	226-81A	39			
	Glycols	NIOSH 5523	1402		60		1000		1		GC-FID	ST	226-57	39			
	Glyphosate	OSHA PV2067			100		1000		100 min		HPLC-UV	F/CST	225-706	96	C/HLD	225-1	102
	Gold	OSHA ID 121			960		2000		8		AA or AES	F/CST	225-3-01	90	C/HLD	225-1	102
	Gold (Elements by ICP HNO ₃ Digestion))	NIOSH 7303			1-3300		1000-4000		varies		ICP-AES	F/CST	225-3-01	90	C/HLD	225-1	102
	Grain dust (oats, wheat, barley)	OSHA CSI		10 mg/m ³	960		2000		8		GR	FLT CST	225-5-37-P 225-2LF	93 97	C/HLD	225-1	102
	Graphite (natural) (see Respirable dust)	OSHA ID 142															
	Graphite (synthetic) (particulates, respirable)	NIOSH 0600	1038		375		2500		2.5		GR	FLT CYC	225-5-37-P 225-01-02	93 111	C/HLD CST	225-1 225-3LF	102 97
	Graphite (synthetic) (particulates, total)	NIOSH 0500	1035		120		2000		1		GR	FLT CST	225-5-37-P 225-2LF	93 97	C/HLD	225-1	102
	Graphite (synthetic) (respirable dust)	OSHA CSI		5 mg/m ³	varies		varies		varies		GR	FLT CYC	225-5-37-P 225-105	93 110	C/HLD CST	225-1 225-3LF	102 97
	Graphite (synthetic) (total dust)	OSHA CSI		15 mg/m ³	960		2000		8		GR	FLT CST	225-5-37-P 225-2LF	93 97	C/HLD	225-1	102
	Graphium species (fungi, molds, spores)	OSHA CSI			120		1000		2		varies	F/CST	225-3-01	90	C/HLD	225-1	102
	Graphium species (fungi, molds, spores)	OSHA CSI			141.5		28300		5 min		varies	BI	225-9611	120			
	Grunerite fibers (see asbestos)	OSHA ID 160															
	Gypsum (particulates, respirable)	NIOSH 0600	1038		375		2500		2.5		GR	FLT CYC	225-5-37-P 225-01-02	93 111	C/HLD CST	225-1 225-3LF	102 97
	Gypsum (particulates, total)	NIOSH 0500	1035		120		2000		1		GR	FLT CST	225-5-37-P 225-2LF	93 97	C/HLD	225-1	102
	Hafnium	OSHA ID 121		0.5 mg/m ³	960		2000		8		AA or AES	F/CST	225-3-01	90	C/HLD	225-1	102
	Halothane	OSHA 103	1347		12		50		4		GC-FID	ST	226-81A	39			
	Halothane	OSHA 29			9		100		1.5		GC-FID	ST	226-01	38			
	Haloxon	OSHA CSI									W	W	225-2401A	140			
	HDI (see hexamethylene diisocyanate)																
	Heptachlor	ASTM D 4861			240-7200		1000-5000		4-24		GC-ECD	PUF	226-92	44			
	Heptachlor	OSHA PV2029		0.5 mg/m ³	60		1000		1		GC-ECD	ST	226-30-16	38			
	Heptachlor (non-occupational exposure)	ASTM D 4947	1417		240-7200	250	1000-5000		4-24		GC-ECD	PUF	226-92	44			
	Heptachlor epoxide	ASTM D 4861			240-7200		1000-5000		4-24		GC-ECD	PUF	226-92	44			
	Heptanal (Aldehydes, Screening)	NIOSH 2539			5		20		4		GC-FID & GC-MS	ST	226-118	40			
	n-Heptane	EPA TO-17	1689		1 L & 4 L		16.7 ml/min & 66.7 ml/min				TD, GC	ST CPC	226-300 Series 224-26-CPC	42 51	TH	224-26-02	51
	n-Heptane	OSHA 07	1156	500	5	3	20	200	4	15	GC-FID	ST	226-01	38			
	3-Heptanone (ethyl butyl ketone) (Ketones II)	NIOSH 2553		50	1-25		10-200		varies		GC-FID	ST	NA SKC				
	2-Heptanone (methyl n-amyl ketone) (Ketones II)	NIOSH 2553		100	1-25		10-200		varies		GC-FID	ST	NA SKC				
	1-Heptene	OSHA CSI			10		20(50)		8(3.3)		GC-FID	ST	226-01	38			
	Hexachloro-1,3-cyclopentadiene	NIOSH 2518		0.01	24		50		8		GC-ECD	ST	226-116	40			
	Hexachlorobenzene	ASTM D 4861			240-7200		1000-5000		4-24		GC-ECD	PUF	226-92	44			
	Hexachlorobenzene	OSHA CSI			480		2000		4		GC-ECD	F/CST	225-706	96	C/HLD	225-1	102
	Hexachlorobutadiene	NIOSH 2543		0.02	48		100		8		GC-ECD	ST	226-30-04	38			
	Hexachlorocyclopentadiene	ASTM D 4861			240-7200		1000-5000		4-24		GC-ECD	PUF	226-124	44			
	Hexachlorocyclopentadiene (hexachloro-1,3-cyclopentadiene)	NIOSH 2518		0.01	48		100		8		GC-ECD	ST	226-116	40			
	Hexachloroethane	OSHA 07	1155	1	30		100		5		GC-FID	ST	226-01	38			

Agency standards for OSHA listings represent the OSHA PELs reported in the 29 CFR 1910.1000 Part 1910, Section 1000.

References and abbreviations are found on pages 212-213.

Chemical Hazard	Agency Reference	Chem F File	SAMPLING ∞								Analytical Method	SKC Collecting Equipment & Page Number							
			Agency Standard		Vol. (liter)		Rate (ml/min)		Time										
			TWA (ppm)	CLG/STEL (ppm)	TWA (Sample Time or Air Volume)	CLG/STEL	TWA (Flow/Sampling Rate)	CLG/STEL	TWA (hrs)	CLG/STEL (min)									
Hexachloroethane (hydrocarbons, halogenated)	NIOSH 1003		1		10			10-200			varies	GC-FID	ST	226-01	38				
Hexachloronaphthalene	OSHA CSI		0.2 mg/m ³		30			1000			30 min	GC-ECD	F/CST	225-3-01	90	C/HL	225-1	102	
Hexamethylene diisocyanate	NIOSH 5522		35 µg/m ³	140 µg/m ³	360	20		1000	2000		6	10	HPLC-FD	IMP	225-36-1	67	IT	225-22	67
1,6-Hexamethylene diisocyanate	OSHA 42	1458			15			1000			15 min		HPLC-UV or HPLC-FD	CF/CST C/HL	225-9002 225-1	or 102	CF/CST	225-9013	64
Hexamethylene diisocyanate (gaseous)	ASTM D 6562				15			1000			15 min		HPLC-UV or HPLC-FD	CF/CST C/HL	225-9023 225-1	or 102	CF/CST	225-9022	64
Hexamethylene diisocyanate (HDI) (isocyanates)	OR-OSHA 1010		0.02	0.02	45	5		1000	1000		45 min	5	HPLC	IMP CF/CST	225-36-1 225-9029	67 64	IT	225-22	67
Hexamethylene diisocyanate (isocyanates)	NIOSH 5521		35 µg/m ³	140 µg/m ³ (10 min) (C)	480	10		1000	1000		8	10	HPLC-ELCHM & HPLC-UV	IMP	225-36-1	67	IT	225-22	67
1,6-Hexamethylene diisocyanate (isocyanates, total)	NIOSH 5525		35 µg/m ³	140 µg/m ³ (10 min) (C)	1-500			1000-2000			varies		HPLC-UV	FLT SP FLT	225-7 ‡ 225-27 225-702 ‡	96 or 96	CST IOM	225-4 225-76A	97 108
Hexamethylene diisocyanate (monomeric aerosol)	ASTM D 6561				15			1000			15 min		HPLC-UV	CF/CST C/HL	225-9023 225-1	or 102	CF/CST	225-9022 ▼	64
Hexamethylene diisocyanate (monomeric gaseous)	ASTM D 6561				15			1000			15 min		HPLC-UV	CF/CST C/HL	225-9023 225-1	or 102	CF/CST	225-9022	64
Hexamethylene diisocyanate (oligomeric aerosol)	ASTM D 6561				15			1000			15 min		HPLC-UV	CF/CST C/HL	225-9023 225-1	or 102	CF/CST	225-9022 ▼	64
Hexamethylene diisocyanate biuret	OSHA PV2030				15			1000			15 min		HPLC-UV	FLT C/HL	225-7 ‡ 225-1	96 102	CST	225-3LF	97
Hexamethylene diisocyanate biuret (HDI-BT) (isocyanates)	OR-OSHA 1010		1.0 mg/m ³	0.5 mg/m ³	45	5		1000	1000		45 min	5	HPLC	IMP CF/CST	225-36-1 225-9029	67 64	IT	225-22	67
Hexamethylene diisocyanate isocyanurate (HDI-IC) (isocyanates)	OR-OSHA 1010		1.0 mg/m ³	0.5 mg/m ³	45	5		1000	1000		45 min	5	HPLC	IMP CF/CST	225-36-1 225-9029	67 64	IT	225-22	67
Hexamethylenediamine	OSHA CSI				12			100			2		HPLC-UV	ST	226-30-18	38			
Hexamethylenetetramine	NON 52				15			1000			15 min		GC-NPD or GC-FID	ST	226-57	39			
Hexamethylenetetramine	OSHA CSI				15			1000			15 min		GC-NPD	F/CST IT	225-3-01 225-22	90 67	IMP	225-36-1	67
Hexanal	ASTM D 5197				varies			500-1200			5 min-24 hrs		HPLC-UV	ST	226-120 °	or	ST	226-119	40
Hexanal (Aldehydes, Screening)	NIOSH 2539				5			20			4		GC-FID & GC-MS	ST	226-118	40			
n-Hexane	EPA TO-17	1689			1 L & 4 L			16.7 ml/min & 66.7 ml/min					TD, GC	ST CPC	226-300 Series 224-26-CPC	42 51	TH	224-26-02	51
n-Hexane	OSHA 07	1154	500		5			20			4		GC-FID	ST	226-01	38			
Hexane (isomers other than n-hexane)	OSHA CSI				4	3		20	200		3.3	15	GC-FID	ST	226-01	38			
1,6-Hexanediol	OSHA CSI				6			100			1		GC-FID	ST	226-09	38			
Hexanediol diacrylate	NON 39				480			1000			8		GC-FID	ST	226-56	39			
1,6-Hexanediol diacrylate	OSHA CSI				10			20(50)			8(3.3)		HPLC	ST	226-95	40			
1,6-Hexanediol diacrylate	OSHA PV2133		1 mg/m ³		48			200			4		GC-FID	ST	226-110	40			
2-Hexanone (Ketones I)	NIOSH 2555				1-10			10-200			varies		GC-FID	ST	NA SKC				
2-Hexanone (methyl butyl ketone)	OSHA 07	1153	100		10			20(50)			8(3.3)		GC-FID	ST	226-01	38			
2-Hexanone (methyl butyl ketone) (Ketones I)	NIOSH 1300		1		10			20(50)			8(3.3)		GC-FID	ST	226-01	38			
Hexavalent chromium	ASTM D 6832				varies			1000-5000			varies		IC	F/CST F/CST	225-802 225-709	or	F/CST F/CST	225-1713 225-401	or 95
Hexavalent chromium	NIOSH 7600	1032	1 µg/m ³ (10 hr)		240			1000			4		VAS	F/CST	225-802	93	C/HL	225-1	102
Hexavalent chromium	NIOSH 7604	1032	1 µg/m ³ (10 hr)		240			1000			4		IC-CD	F/CST	225-802	93	C/HL	225-1	102
Hexavalent chromium	NIOSH 7605		0.001 mg/m ³ (10 hr)		1-400			1000-4000			varies		IC-PCD-UV	F/CST	225-802	93	C/HL	225-1	102
Hexavalent chromium	NIOSH 7703		0.001 mg/m ³ (10 hr)		10-1200			1000-4000			varies		P VAS	F/CST	225-802	93	C/HL	225-1	102
Hexavalent chromium	OSHA ID 103		0.005 mg/m ³ (C)		960	30		2000	2000		8	15	DPP	F/CST	225-802	93	C/HL	225-1	102
Hexavalent chromium	OSHA W4001		0.005 mg/m ³ (C)										IC-UV	FLT	225-5-37	or	FLT	225-1822	95
Hexavalent chromium (CR(VI))	OSHA ID 215 (V2)	1439	0.005 mg/m ³		960			2000			8		IC-UV	F/CST	225-802	93	C/HL	225-1	102
Hexavalent chromium (in settled dust)	NIOSH 9101				bulk	bulk							CLR or VAS or IC						
Hexone	EPA TO-17	1689			1 L & 4 L			16.7 ml/min & 66.7 ml/min					TD, GC	ST CPC	226-300 Series 224-26-CPC	42 51	TH	224-26-02	51
Hexone	OSHA 1004		100					13.62			8		GC-FID	PS	575-002	75			
Hexone	OSHA 1004		100		12			50			4		GC-FID	ST	NA SKC				
Hexone (Ketones I)	NIOSH 2555		50		1-10			10-200			varies		GC-FID	ST	NA SKC				
Hexone (methyl isobutyl ketone)	OSHA 07		100		10			20(50)			8(3.3)		GC-FID	ST	226-01	38			
Hexone (methyl isobutyl ketone) (Ketones I)	NIOSH 1300		50	75	10	3		20(50)	200		8(3.3)	15	GC-FID	ST	226-01	38			
n-Hexyl acetate	OSHA CSI				6			200			30 min		GC-FID	ST	226-01	38			

Agency standards for OSHA listings represent the OSHA PELs reported in the 29 CFR 1910.1000 Part 1910, Section 1000.

References and abbreviations are found on pages 212-213.

Sampling Guide

www.skcinc.com for updates

H

Chemical Hazard	Agency Reference	Chem F File	SAMPLING ∞								Analytical Method	SKC Collecting Equipment & Page Number				
			Agency Standard		Vol. (liter)		Rate (ml/min)		Time							
			TWA (ppm)	CLG/STEL (ppm)	TWA (Sample Time or Air Volume)	CLG/STEL	TWA (Flow/Sampling Rate)	CLG/STEL	TWA (hrs)	CLG/STEL (min)						
sec-Hexyl acetate	OSHA 07	1152	50		10		20(50)		8(3.3)		GC-FID	ST	226-01	38		
Hexyl alcohol	OSHA CSI				10		20(50)		8(3.3)		GC-FID	ST	226-01	38		
Hexyl carbitol	OSHA CSI				6		200		30 min		GC-FID	ST	226-01	38		
Hexylene glycol	OSHA PV2101					3	200		15		GC-FID	ST	226-01	38		
HMX	OSHA PV2032				480		1000		8		HPLC-UV	F/CST	225-709	96	C/HLD	225-1 102
HydramethylNON OSHA CSI					90		1000		1.5		HPLC-UV	F/CST	225-3-01	90	C/HLD	225-1 102
Hydrazine	NIOSH 3503			0.03 (120 min)	90		1000		1.5		VAS	IMP	225-36-2	67	IT	225-22 67
Hydrazine	NON 22				96		200		8		CLR	ST	226-42-02	39		
Hydrazine	OSHA 108		1		240		1000		4		IC-UV	CF/CST	225-9012	64	C/HLD	225-1 102
Hydrazine	OSHA 20	1281	1		20		100		3.3		HPLC-UV	ST	226-42-02	39		
Hydrazoic acid	NON 25				15		1000		15		HPLC-UV	ST	226-55	39		
Hydrazoic acid	OSHA ID 211				5		1000		5		IC-UV	ST	226-55	39	FLT	225-5-37-P 93
											CST	225-2LF	97	SPC	225-23	103
											C/HLD	225-1	102			
Hydrocarbons BP 36 to 216 C (see specific compounds)	NIOSH 1500			varies	varies		varies		varies		GC-FID	ST	226-01	38		
Hydrocarbons, aromatic (see specific compounds)	NIOSH 1501	1453		varies	varies		varies		varies		GC-FID	ST	226-01	38		
Hydrocarbons, halogenated (see specific compounds)	NIOSH 1003	1454		varies	varies		varies		varies		GC-FID	ST	226-01	38		
Hydrofluoric acid (fluorides)	NIOSH 7906		3	6	960	30	2000	2000	8	15	IC-CD	CF/CST	225-9031	64	C/HLD	225-1 102
Hydrogen bromide	NIOSH 7907			3	30		2000		15		IC-CD	CF/CST	225-9032	64		
Hydrogen bromide	OSHA ID 165SG		3		97	3	200	200	8	15	IC	ST	226-10-03	38		
Hydrogen chloride	NIOSH 7907			5	30		2000		15		IC-CD	CF/CST	225-9032	64		
Hydrogen chloride (hydrochloric acid)	OSHA ID 174SG			5	7.5		500		15		IC	ST	226-10-03	38		
Hydrogen cyanide	NIOSH 6010			4.7	2-90		50-200		varies		VAS	ST	226-28	38		
Hydrogen cyanide	NIOSH 6017			4.7	2-90		50-200		varies		IC/ELCM	ST	226-28	38		
Hydrogen cyanide	OSHA 1015		10				28.4		8	15	IC-ELCM	PS	590-400	86		
Hydrogen cyanide	OSHA ID 120		10		120	15	1000	1000	2	15	ISE	CST	225-3LF	97	IMP	225-36-2 67
											IT	225-22	67	FLT	225-5	88
											SP	225-2902	103			
Hydrogen cyanide (cyanides)	NIOSH 7904			5 mg/m³ (10 min)	15		1000		15		ISE	FLT	225-2705 Δ	94	CST	225-2LF 97
											IMP	225-36-2	67	IT	225-22	67
											C/HLD	225-1	102			
Hydrogen fluoride	NIOSH 7906		3	6	960	30	2000	2000	8	15	IC-CD	CF/CST	225-9031	64	C/HLD	225-1 102
Hydrogen fluoride (as F)	OSHA ID 110		3	6	90	22	1500	1500	1	15	ISE	CF/CST	225-9001	64	C/HLD	225-1 102
Hydrogen fluoride (fluorides)	NIOSH 7902		3	6	480	30	1000	2000	8	15	ISE	CF/CST	225-9001	64	C/HLD	225-1 102
Hydrogen peroxide	OSHA 1019			1.0 (1.4 mg.m³)	240	30	1000	2000	4	15	VAS	CF/CST	225-9030	64	C/HLD	225-1 102
Hydrogen selenide (as Se)	OSHA CSI			0.05	480		1000		8		AA	IMP	225-36-2	67	IT	225-22 67
Hydrogen sulfide	NIOSH 6013			10(10min)	24	3	100	300	4	10	IC	ST	NA SKC			
Hydrogen sulfide	NON 42	1414			12		1000		12 min		GC-FFD	SB	231-10	54		
Hydrogen sulfide	OSHA 1008		10	20	12	7.5	50	500	4	15	IC	ST	226-177	41		
Hydrogenated terphenyls	OSHA CSI				30		1000				GC-FID	FLT	225-17-04	94	CST	225-2LF 97
											C/HLD	225-1	102			
Hydroquinone	NIOSH 5004			2 mg/m³ (15 min)	30		2000		15		HPLC-UV	F/CST	225-3-01	90	C/HLD	225-1 102
Hydroquinone	OSHA PV2094			2 mg/m³	20		200		100 min		HPLC-UV	ST	226-98	40		
2-Hydroxy-4-methoxyacetophenone	OSHA CSI				10		200		50 min		HPLC-UV	ST	226-30	38		
4-Hydroxy-4-methyl-2-pentanone (see diacetone alcohol)																
4-Hydroxy-4-methyl-2-pentanone (alcohols combined)	NIOSH 1405		50		1-10		10-200		varies		GC-FID	ST	226-01	38		
m-Hydroxyacetophenone	OSHA CSI				10		200		50 min		HPLC-UV	ST	226-30-04	38		
m-Hydroxybenzoic acid	OSHA CSI				180		1000		3		HPLC-UV	F/CST	225-3-01	90	C/HLD	225-1 102
4-Hydroxycoumarin	OSHA CSI				10		200		50 min		HPLC-UV	ST	226-30-04	38		
Hydroxyethyl acrylate	OSHA CSI				12		200		2		GC-FID	ST	226-15GWS	38		
2-Hydroxyethyl methacrylate	OSHA CSI				10		200		50 min		GC-FID	ST	226-01	38		
2-Hydroxypropyl acrylate	OSHA PV2078				10		100		100 min		GC-FID	ST	226-73	39		
2-Imidazolidinethione (ethylene thiourea)	NIOSH 5011		LFC		480		1000		8		VAS	F/CST	225-803	93	C/HLD	225-1 102
Indene	OSHA CSI				10		20(50)		8(3.3)		GC-FID	ST	226-110	40		
Indeno(1,2,3-cd)pyrene (Polynuclear Aromatic Hydrocarbons by GC)	NIOSH 5515				480		2000		4		GC-FID	F/CST	225-1713	94	ST	226-30-04 38
											C/HLD	225-1	102			
Indeno(1,2,3-cd)pyrene (Polynuclear Aromatic Hydrocarbons by GC-MS)	ASTM D 6209				350 m³ (max)		225 L/min		1-24		GC-MS	PUF	226-131	45	FLT	225-1808 95
Indeno(1,2,3-cd)pyrene (Polynuclear Aromatic Hydrocarbons by HPLC)	NIOSH 5506				480		2000		4		HPLC-FD	F/CST	225-1713	94	ST	226-30-04 38
											C/HLD	225-1	102			

Agency standards for OSHA listings represent the OSHA PELs reported in the 29 CFR 1910.1000 Part 1910, Section 1000.

References and abbreviations are found on pages 212-213.

Chemical Hazard	Agency Reference	Chem F File	SAMPLING ∞								Analytical Method	SKC Collecting Equipment & Page Number				
			Agency Standard		Vol. (liter)		Rate (ml/min)		Time							
			TWA (ppm)	CLG/STEL (ppm)	TWA (Sample Time or Air Volume)	CLG/STEL	TWA (Flow/Sampling Rate)	CLG/STEL	TWA (hrs)	CLG/STEL (min)						
Indium	OSHA ID 121		0.1 mg/m ³	960		2000		8		AA or AES	F/CST	225-3-01	90	C/HLD	225-1	102
Indium & compounds (as In)	OSHA CSI		0.1 mg/m ³	960		2000		8		ICP-DCP	F/CST	225-3-01	90	C/HLD	225-1	102
Indium (Elements by Cellulosic Internal Capsule Sampler)	NIOSH 7306		0.1 mg/m ³	8-2000		1000-4000		Varies		ICP-AES	SC	225-8517	90	C/HLD	225-1	102
Indium (Elements by ICP HNO ₃ Digestion)	NIOSH 7303			15-500,000		1000-4000		varies		ICP-AES	F/CST	225-3-01	90	C/HLD	225-1	102
Iodine	NIOSH 6005		0.1	15		1000		15		IC	ST	226-67	39			
Iodine	NON 16			48		100		8		IC	ST	226-67	39			
Iodine	OSHA ID 212		0.1 (C)	2.5		500		5		IC	ST	226-80	39			
Iodine (particulates)	OSHA ID 212		0.1	2.5		500		5		IC	ST	226-142	41			
Iodine (vapor)	OSHA ID 212		0.1	2.5		500		5		IC	ST	226-80	39			
Iodoform	OSHA CSI			10		100		100 min		GC-ECD	F/CST C/HLD	225-706 225-1	96 102	ST	226-93	40
Iridium	OSHA CSI			960		2000		8		AA	F/CST	225-3-01	90			
Iron	OSHA ID 121			960		2000		8		AA or AES	F/CST	225-3-01	90	C/HLD	225-1	102
Iron & compounds (as Fe)	OSHA ID 121	1209		960		2000		8		AA or AES	F/CST	225-3-01	90	C/HLD	225-1	102
Iron (bulk)	OSHA ID 125G			480		2000		4		ICP-AES	F/CST F/CST C/HLD	225-3-01 225-803 225-1	or or 102	F/CST F/CST	225-3100 225-8215	or 93
Iron (Elements by Cellulosic Internal Capsule Sampler)	NIOSH 7306		5 mg/m ³ (dust, fume) as Fe	2-500		1000-4000		Varies		ICP-AES	SC	225-8517	90	C/HLD	225-1	102
Iron (Elements by ICP Aqua Regia Ashing)	NIOSH 7301		5 mg/m ³ (dust, fume)	5-100		1000-4000		varies		ICP-AES	F/CST C/HLD	225-3-01 225-1	or 102	F/CST	225-803	¥ 93
Iron (Elements by ICP HNO ₃ Digestion)	NIOSH 7303		0.5 mg/m ³ (dust, fume)	1-5000		1000-4000		varies		ICP-AES	F/CST	225-3-01	90	C/HLD	225-1	102
Iron (Elements by ICP HNO ₃ /HClO ₄ Ashing)	NIOSH 7300	1455	5 mg/m ³ (dust, fume)	5-100		1000-4000		varies		ICP-AES	F/CST	225-3-01	90	C/HLD	225-1	102
Iron (Elements on Wipes)	NIOSH 9102			wipe						ICP-AES	W TMP	225-2414 225-2415	140 140	TMP	225-2403	or
Iron oxide (Elements by ICP HNO ₃ Digestion)	NIOSH 7303			1-5000		1000-4000		varies		ICP-AES	F/CST	225-3-01	90	C/HLD	225-1	102
Iron oxide fume	OSHA ID 121	1045	10 mg/m ³	960		2000		8		AA or AES	F/CST	225-3-01	90	C/HLD	225-1	102
Iron oxide fume	OSHA ID 125G		10 mg/m ³	480		2000		4		ICP-AES	F/CST F/CST C/HLD	225-3-01 225-803 225-1	or or 102	F/CST F/CST	225-3100 225-8215	or 93
Iron pentacarbonyl (as Fe)	OSHA CSI			480	30	2000	2000	4	15	CLR	IMP	225-36-2	67	IT	225-22	67
Iron salts, soluble (as Fe)	OSHA ID 121	1208		960		2000		8		AA or AES	F/CST	225-3-01	90	C/HLD	225-1	102
Isoamyl acetate	OSHA 07	1151	100	10		20(50)		8(3.3)		GC-FID	ST	226-01	38			
Isoamyl acetate (Esters I)	NIOSH 1450		100	1-10		10-200		varies		GC-FID	ST	226-01	38			
Isoamyl alcohol	OSHA CSI		100	10	3	20(50)	200	8(3.3)	15	GC-FID	ST	226-01	38			
Isoamyl alcohol (alcohols combined)	NIOSH 1405		100	125 (skin)	1-10	1-10	10-200	10-200	varies	varies	GC-FID	ST	226-01	38		
Isoamyl alcohol (alcohols III)	NIOSH 1402		100	125	10	3	20(50)	200	8(3.3)	15	GC-FID	ST	226-01	38		
Isoamyl nitrite	OSHA CSI			5		20		4		HPLC-UV	ST	226-01	38			
Isobutanol (isobutyl alcohol)	EPA TO-17	1689		1 L & 4 L		16.7 ml/min & 66.7 ml/min				TD, GC	ST CPC	226-300 Series 224-26-CPC	42 51	TH	224-26-02	51
Isobutyl acetate	EPA TO-17	1689		1 L & 4 L		16.7 ml/min & 66.7 ml/min				TD, GC	ST CPC	226-300 Series 224-26-CPC	42 51	TH	224-26-02	51
Isobutyl acetate	OSHA 07	1150	150	10		20(50)		8(3.3)		GC-FID	ST	226-01	38			
Isobutyl acetate	OSHA 1009	1750	150	12	0.75	50	50	4	15	GC-FID	ST	226-01	38			
Isobutyl acetate	OSHA 1009	1750	150			13.16	13.16	8	15	GC-FID	PS	575-002	75			
Isobutyl acetate (Esters I)	NIOSH 1450		150	1-10		10-200		varies		GC-FID	ST	226-01	38			
Isobutyl acrylate	OSHA CSI			10		20(50)		8(3.3)		GC-FID	ST	226-01	38			
Isobutyl alcohol	OSHA 07	1149	100	10		20(50)		8(3.3)		GC-FID	ST	226-01	38			
Isobutyl alcohol (alcohols combined)	NIOSH 1405		50	2-10		10-200		varies		GC-FID	ST	226-01	38			
Isobutyl alcohol (alcohols II)	NIOSH 1401		50	10		20(50)		8(3.3)		GC-FID	ST	226-01	38			
Isobutyl alcohol (isobutanol)	EPA TO-17	1689		1 L & 4 L		16.7 ml/min & 66.7 ml/min				TD, GC	ST CPC	226-300 Series 224-26-CPC	42 51	TH	224-26-02	51
Isobutyl isobutyrate	OSHA PV2090			10		200		50 min		GC-FID	ST	226-01	38			
Isobutyl nitrite	OSHA CSI			5		20		4		HPLC-UV	ST	226-01	38			
Isobutylbenzene	OSHA CSI			6		200		30 min		GC-FID	ST	226-01	38			
Isobutyraldehyde (Aldehydes, Screening)	NIOSH 2539			5		20		4		GC-FID & GC-MS	ST	226-118	40			
Isobutyric acid	OSHA CSI			6		100		1		GC-FID	ST	226-110	40			
Isobutyronitrile	OSHA CSI			10		20(50)		8(3.3)		GC-FID	ST	226-01	38			

Agency standards for OSHA listings represent the OSHA PELs reported in the 29 CFR 1910.1000 Part 1910, Section 1000.

References and abbreviations are found on pages 212-213.

Sampling Guide

www.skinc.com for updates

I

Chemical Hazard	Agency Reference	Chem F File	SAMPLING ∞								Analytical Method	SKC Collecting Equipment & Page Number					
			Agency Standard		Vol. (liter)		Rate (ml/min)		Time								
			TWA (ppm)	CLG/STEL (ppm)	TWA (Sample Time or Air Volume)	CLG/STEL	TWA (Flow/Sampling Rate)	CLG/STEL	TWA (hrs)	CLG/STEL (min)							
Isocyanates (see specific isocyanate)	NIOSH 5521	1459	varies		480	10	1000	1000	8	10	HPLC-ELCHM & HPLC-UV	IMP	225-36-1	67	IT	225-22	67
Isocyanates (see specific isocyanate)	NIOSH 5522	1460	varies	varies	360	20	1000	2000	6	10	HPLC-FD	IMP	225-36-1	67	IT	225-22	67
Isocyanates (see specific isocyanate)	OR-OSHA 1010		varies	varies	45	5	1000	1000	45 min	5	HPLC	IMP CF/CST	225-36-1 225-9029	67 64	IT	225-22	67
Isocyanates, total (see specific isocyanate)	NIOSH 5525		varies	varies	1-500	1-500	1000-2000	1000-2000	varies	varies	HPLC-UV	FLT SP FLT	225-7 ‡ 225-27 225-702 ‡	96 or 96	CST IOM	225-4 225-76A	97 108
Isophenphos	OSHA CSI				480		1000		8		GC-FPD	ST	226-30-16	38			
Isoflurane	OSHA 103	1349			12		50		4		GC-FID	ST	226-81A	39			
Isooctyl alcohol	OSHA PV2033		100		10		20(50)		8(3.3)		GC-FID	ST	226-01	38			
Isophorone	NIOSH 2508		4		10		20(50)		8(3.3)		GC-FID	ST	226-81A	39			
Isophorone	NIOSH 2556		4		2-25		10-100		varies		GC-FID	ST	226-93	40			
Isophorone	OSHA 07	1160	25		10		20(50)		8(3.3)		GC-FID	ST	226-81A	39			
Isophorone (3,5,5-Trimethylcyclohex-2-enone)	EPA TO-17	1689			1 L & 4 L		16.7 ml/min & 66.7 ml/min				TD, GC	ST CPC	226-300 Series 224-26-CPC	42 51	TH	224-26-02	51
Isophorone diisocyanate	OSHA PV2034				60	15	1000	1000	1	15	HPLC-UV	CF/CST	225-9002	64	C/HLD	225-1	102
Isophorone diisocyanate (IPDI)	OR-OSHA 1010		0.02	0.02	45	5	1000	1000	45 min	5	HPLC	IMP CF/CST	225-36-1 225-9029	67 64	IT	225-22	67
Isophorone diisocyanate (isocyanates, total)	NIOSH 5525		45 µg/m³	180 µg/m³ (10 min) C	1-500		1000-2000		varies		HPLC-UV	FLT SP FLT	225-7 ‡ 225-27 225-702 ‡	96 or 96	CST IOM	225-4 225-76A	97 108
Isophthalic acid	OSHA CSI				bulk						HPLC-UV						
Isopropanol (isopropyl alcohol)	EPA TO-17	1689			1 L & 4 L		16.7 ml/min & 66.7 ml/min				TD, GC	ST CPC	226-300 Series 224-26-CPC	42 51	TH	224-26-02	51
Isopropyl acetate	EPA TO-17	1689			1 L & 4 L		16.7 ml/min & 66.7 ml/min				TD, GC	ST CPC	226-300 Series 224-26-CPC	42 51	TH	224-26-02	51
Isopropyl acetate	NIOSH 1454				9		50		3		GC-FID	ST	226-01	38			
Isopropyl acetate	NIOSH 1460				0.1-9.0		20-200		varies		GC-FID	ST	226-01	38			
Isopropyl acetate	OSHA 07	1148	250		10	3	20(50)	200	8(3.3)	15	GC-FID	ST	226-01	38			
Isopropyl alcohol	OSHA 07	1147	400		3	1.5	20	100	2.5	15	GC-FID	ST	226-01	38			
Isopropyl alcohol	OSHA 109		400		18	3	50	200	6	15	GC-FID	ST	226-82	40			
Isopropyl alcohol (Alcohols I)	NIOSH 1400		400	500	3	3	20	200	2.5	15	GC-FID	ST	226-01	38			
Isopropyl alcohol (isopropanol)	EPA TO-17	1689			1 L & 4 L		16.7 ml/min & 66.7 ml/min				TD, GC	ST CPC	226-300 Series 224-26-CPC	42 51	TH	224-26-02	51
Isopropyl amine	OSHA CSI		5		90	15	1000	1000	1.5	15	GC-FID	IMP	225-36-2	67	IT	225-22	67
N-Isopropyl aniline	OSHA 78	1228			100		1000		100 min		HPLC-UV	CF/CST	225-9004	64	C/HLD	225-1	102
Isopropyl benzen (cumene)	EPA TO-17	1689			1 L & 4 L		16.7 ml/min & 66.7 ml/min				TD, GC	ST CPC	226-300 Series 224-26-CPC	42 51	TH	224-26-02	51
Isopropyl bromide	OSHA CSI				12		100		2		GC-FID	ST	226-01	38			
Isopropyl CELLOSOLVE solvent (see ethylene glycol isopropyl ether)	OSHA CSI																
Isopropyl ether	NIOSH 1618		500		0.1-3		10-50		varies		GC-FID	ST	226-01	38			
Isopropyl ether	OSHA 07	1146	500		3	0.75	20	50	2.5	15	GC-FID	ST	226-01	38			
Isopropyl glycidyl ether	NIOSH 1620			50 (15 min)		3		200		15	GC-FID	ST	226-01	38			
Isopropyl glycidyl ether	OSHA 07	1145	50		10	3	20(50)	200	8(3.3)	15	GC-FID	ST	226-01	38			
Isopropyl m-chlorocarbaniolate	OSHA CSI				30		1000		30 min		HPLC-UV	IMP	225-36-1	67	IT	225-22	67
Isovaleraldehyde	ASTM D 5197				varies		500-1200		5 min-24 hrs		HPLC-UV	ST	226-120 °	or	ST	226-119	40
Isovaleraldehyde (Aldehydes, Screening)	NIOSH 2539				5		20		4		GC-FID & GC-MS	ST	226-118	40			
Jet fuel	OSHA CSI					3		200		15	GC-FID	ST	226-01	38			
Kaolin (particulates, respirable)	NIOSH 0600	1038			375		2500		2.5		GR	FLT CYC	225-5-37-P 225-01-02	93 111	C/HLD CST	225-1 225-3LF	102 97
Kaolin (particulates, total)	NIOSH 0500	1035			120		2000		1		GR	FLT CST	225-5-37-P 225-2LF	93 97	C/HLD	225-1	102
Kaolin (respirable dust)	OSHA CSI		5 mg/m³		varies		varies		varies		GR	FLT CYC	225-5-37-P 225-105	93 110	C/HLD CST	225-1 225-3LF	102 97
Kaolin (total dust)	OSHA CSI		15 mg/m³		960		2000		8		GR	F/CST	225-803	93	C/HLD	225-1	102
Kathon 886 (kathon biocide)	NON 55				50	7.5	200	500	4	15	HPLC-UV	ST	226-99	40			
Kepone	NIOSH 5508		1 µg/m³		480		1000		8		GC-ECD	F/CST IT	225-3-01 225-22	90 67	IMP	225-36-1	67
Kepone	OSHA CSI				480		1000		8		GC-ECD	F/CST IT	225-3-01 225-22	90 67	IMP	225-36-1	67
Kerosene	OSHA CSI				10		20(50)		8(3.3)		GC-FID	ST	226-01	38			
Kerosene	OSHA PV2139				20		100		200 min		GC-FID	ST	226-01	38			

Agency standards for OSHA listings represent the OSHA PELs reported in the 29 CFR 1910.1000 Part 1910, Section 1000.

References and abbreviations are found on pages 212-213.

Chemical Hazard	Agency Reference	Chem F File	SAMPLING ∞								Analytical Method	SKC Collecting Equipment & Page Number							
			Agency Standard		Vol. (liter)		Rate (ml/min)		Time										
			TWA (ppm)	CLG/STEL (ppm)	TWA (Sample Time or Air Volume)	CLG/STEL	TWA (Flow/Sampling Rate)	CLG/STEL	TWA (hrs)	CLG/STEL (min)									
Kerosene (naphthas)	NIOSH 1550		100 mg/m ³		10			20(50)			8(3.3)		GC-FID	ST	226-01	38			
Ketene	OSHA CSI		0.5		50	15		1000	1000		50 min	15	CLR	IMP	225-36-2	67	IT	225-22	67
Ketones	EPA TO-5	1671			< 80 L			100-1000 ml/min					HPLC-UV	IMP	225-36-1	67	IT	225-22	67
Ketones (screening)	NIOSH 2549				5			20			4		GC-MS	ST	226-330	42			
Ketones I (see specific compounds)	NIOSH 1300		varies		varies			10-200			varies		GC-FID	ST	226-01	38			
Ketones I (see specific compounds)	NIOSH 2555				varies			varies			varies		GC-FID	ST	NA SKC				
Ketones II (see specific compounds)	NIOSH 1301		varies		varies			varies			8		GC-FID	ST	226-01	38			
Ketones II (see specific ketone)	NIOSH 2553		varies	varies	1-25	1-25		10-200	10-200		varies	varies	GC-FID	ST	NA SKC				
Lactic Acid	OSHA CSI				800			2000			400 min		IC	ST	226-01	pp cc			
Lactose powder	NON 53												F/CST CST	225-1725 225-2257	or and	FLT SP	225-2714 225-2901	and 103	
Lake Red C	OSHA CSI				300			2000			2.5		HPLC-UV	F/CST	225-709	96	C/HLD	225-1	102
Landrin	OSHA CSI				60			1000			1		HPLC-UV	ST	226-30-16	38			
Lanthanum (Elements by Cellulosic Internal Capsule Sampler)	NIOSH 7306				Varies			1000-4000			Varies		ICP-AES	SC	225-8517	90	C/HLD	225-1	102
Lanthanum (Elements by ICP Aqua Regia Ashing)	NIOSH 7301				5-1000			1000-4000			varies		ICP-AES	F/CST C/HLD	225-3-01 225-1	or 102	F/CST	225-803	¥ 93
Lanthanum (Elements by ICP HNO ₃ /HClO ₄ Ashing)	NIOSH 7300	1455			5-1000			1000-4000			varies		ICP-AES	F/CST	225-3-01	90	C/HLD	225-1	102
Lanthanum (Elements on Wipes)	NIOSH 9102				wipe								ICP-AES	W TMP	225-2414 225-2415	140 140	TMP	225-2403	or
Lasso (aroclor)	OSHA PV2035				100			1000			100 min		HPLC-UV	F/CST	225-706	96	C/HLD	225-1	102
Lead	NIOSH 7082	1034	< 0.1 mg/m ³		720			1500			8		AAS-F	F/CST	225-3-01	90	C/HLD	225-1	102
Lead	NIOSH 7105	1034	< 0.1 mg/m ³		720			1500			8		AAS-GF	F/CST	225-3-01	90	C/HLD	225-1	102
Lead (by field portable XRF)	NIOSH 7702		< 0.1 mg/m ³		960			2000			8		XRF	F/CST	225-3-01	90			
Lead (by portable ultrasound extraction/ASV)	NIOSH 7701		0.05 mg/m ³		20-1500			1000-4000			varies		P ASV	F/CST	225-3-01	90	C/HLD	225-1	102
Lead (Elements by Cellulosic Internal Capsule Sampler)	NIOSH 7306		0.05 mg/m ³		4-2000			1000-4000			Varies		ICP-AES	SC	225-8517	90	C/HLD	225-1	102
Lead (Elements by ICP Aqua Regia Ashing)	NIOSH 7301		0.05 mg/m ³		50-2000			1000-4000			varies		ICP-AES	F/CST C/HLD	225-3-01 225-1	or 102	F/CST	225-803	¥ 93
Lead (Elements by ICP HNO ₃ Digestion))	NIOSH 7303		0.5 mg/m ³		35-100,000			1000-4000			varies		ICP-AES	F/CST	225-3-01	90	C/HLD	225-1	102
Lead (Elements by ICP HNO ₃ /HClO ₄ Ashing)	NIOSH 7300	1034	0.05 mg/m ³		50-2000			1000-4000			varies		ICP-AES	F/CST	225-3-01	90	C/HLD	225-1	102
Lead (Elements on Wipes)	NIOSH 9102				wipe								ICP-AES	W TMP	225-2414 225-2415	140 140	TMP	225-2403	or
Lead (ICP analysis of metal/metalloid particulates from solder operations)	OSHA ID 206				480			2000			4		ICP-AES	F/CST	225-3-01	90	C/HLD	225-1	102
Lead (in dust wipes)	NIOSH 9105												SPOT	W	550-001	or	W	550-002	139
Lead (in surface dust)	ASTM E 1792				bulk								Varies	W	225-2414	140	TMP	225-2403	140
Lead (in surface dust)	OSHA ID 125G				wipe								ICP-AES	W	225-2414	140	TMP	225-2403	140
Lead (in workplace air)	ASTM D 6785				varies			varies			varies		AAS-F	IOM	225-70A	108	FLT	225-1930	88
Lead (on surfaces)	NIOSH 9100												AA-F or AA-GF or ICP	W	225-2401A	140			
Lead chromate (as Pb)	OSHA CSI		50 µg/m ³		960			2000			8		AA	F/CST	225-3-01	90	C/HLD	225-1	102
Lead chromate (as Pb) (see lead, inorganic fumes & dusts or chromic acid & chromates)	OSHA CSI																		
Lead chromate (CR(VI))	OSHA ID 215 (V2)	1439	0.005 mg/m ³		960			2000			8		IC-UV	F/CST	225-802	93	C/HLD	225-1	102
Lead oxide (as lead)	NIOSH 7082	1034	< 0.1 mg/m ³		720			1500			8		AAS-F	F/CST	225-3-01	90	C/HLD	225-1	102
Lead oxide (as Pb)	NIOSH 7105	1034	< 0.1 mg/m ³		720			1500			8		AAS-GF	F/CST	225-3-01	90	C/HLD	225-1	102
Lead oxide (by field portable XRF)	NIOSH 7702		< 0.1 mg/m ³		960			2000			8		XRF	F/CST	225-3-01	90			
Lead oxide (by portable ultrasound extraction/ASV)	NIOSH 7701		0.05 mg/m ³		20-1500			1000-4000			varies		P ASV	F/CST	225-3-01	90	C/HLD	225-1	102
Lead sulfide (as Pb)	NIOSH 7505		< 0.1 mg/m ³		750			2500			5		XRD	F/CST CYC	225-803 225-01-02	93 111	C/HLD	225-1	102
Lead, inorganic fumes & dusts (as Pb)	OSHA ID 121	1196	0.05 mg/m ³		960	30		2000	2000		8	15	AA or AES	F/CST	225-3-01	90	C/HLD	225-1	102
Lead, inorganic fumes & dusts (as Pb)	OSHA ID 125G		0.05 mg/m ³		480	30		2000	15		4		ICP-AES	F/CST F/CST C/HLD	225-3-01 225-803 225-1	or or 102	F/CST F/CST	225-3100 225-8215	or 93
Lead, inorganic surface dusts (as Pb)	OSHA ID 121	1179											AA or AES	W	225-2401A	140			
Limestone (particulates, total)	NIOSH 0500	1035			120			2000			1		GR	FLT CST	225-5-37-P 225-2LF	93 97	C/HLD	225-1	102
Limestone (see calcium carbonate)																			
Limestone (see dust, total & respirable nuisance)																			
Limone	OSHA PV2036				10			20(50)			8(3.3)		GC-FID	ST	226-01	38			
Limone (terpenes)	NIOSH 1552				24			50			8		GC-FID	ST	226-01	38			
Lindane	OSHA CSI		0.5 mg/m ³		240			1000			4		GC-ECD	F/CST IMP	225-706 225-36-1	96 67	C/HLD IT	225-1 225-22	102 67

K

Agency standards for OSHA listings represent the OSHA PELs reported in the 29 CFR 1910.1000 Part 1910, Section 1000.

References and abbreviations are found on pages 212-213.

Sampling Guide

www.skinc.com for updates

L

Chemical Hazard	Agency Reference	Chem F File	SAMPLING ∞								Analytical Method	SKC Collecting Equipment & Page Number			
			Agency Standard		Vol. (liter)		Rate (ml/min)		Time						
			TWA (ppm)	CLG/STEL (ppm)	TWA (Sample Time or Air Volume)	CLG/STEL	TWA (Flow/Sampling Rate)	CLG/STEL	TWA (hrs)	CLG/STEL (min)					
Lindane (gamma-BHC)	ASTM D 4861			240-7200		1000-5000		4-24		GC-ECD	PUF 226-92	44			
Linuron	ASTM D 4861			240-7200		1000-5000		4-24		HPLC-UV	PUF 226-92	44			
Linuron	OSHA CSI			240		1000		4		HPLC-UV	F/CST 225-706	96	C/HLD 225-1	102	
Lithium	OSHA ID 121			960		2000		8		AA or AES	F/CST 225-3-01	90	C/HLD 225-1	102	
Lithium (Elements by Cellulosic Internal Capsule Sampler)	NIOSH 7306			Varies		1000-4000		Varies		ICP-AES	SC 225-8517	90	C/HLD 225-1	102	
Lithium (Elements by ICP Aqua Regia Ashing)	NIOSH 7301			100-2000		1000-4000		varies		ICP-AES	F/CST 225-3-01 C/HLD 225-1	or 102	F/CST 225-803	¥ 93	
Lithium (Elements by ICP HNO ₃ /HClO ₄ Ashing)	NIOSH 7300	1455		100-2000		1000-4000		varies		ICP-AES	F/CST 225-3-01	90	C/HLD 225-1	102	
Lithium hydride (as Li)	OSHA ID 121		0.025 mg/m ³	960		2000		8		AA or AES	F/CST 225-3-01	90	C/HLD 225-1	102	
Lithium hydroxide (alkaline dust)	NIOSH 7401			960		2000		8		TITRA	F/CST 225-1715	94	C/HLD 225-1	102	
Lithium hydroxide (as Li)	OSHA ID 121			960		2000		8		AA or AES	F/CST 225-3-01	90	C/HLD 225-1	102	
Machette	OSHA CSI			100		1000		100 min		HPLC-UV	F/CST 225-706	96	C/HLD 225-1	102	
Magnesite (particulates, respirable)	NIOSH 0600	1038		375		2500		2.5		GR	FLT 225-5-37-P CYC 225-01-02	93 111	C/HLD 225-1 CST 225-3LF	97	
Magnesite (particulates, total)	NIOSH 0500	1035		120		2000		1		GR	FLT 225-5-37-P CST 225-2LF	93	C/HLD 225-1	102	
Magnesite (see dust, total & respirable nuisance)	OSHA CSI														
Magnesium	OSHA ID 121	1192		960	30	2000	2000	8	15	AA or AES	F/CST 225-3-01	90	C/HLD 225-1	102	
Magnesium (Elements by Cellulosic Internal Capsule Sampler)	NIOSH 7306			1-330		1000-4000		Varies		ICP-AES	SC 225-8517	90	C/HLD 225-1	102	
Magnesium (Elements by ICP Aqua Regia Ashing)	NIOSH 7301		10 mg/m ³ (fume, as oxide)	5-67		1000-4000		varies		ICP-AES	F/CST 225-3-01 C/HLD 225-1	or 102	F/CST 225-803	¥ 93	
Magnesium (Elements by ICP HNO ₃ Digestion)	NIOSH 7303			1-10,000		1000-4000		varies		ICP-AES	F/CST 225-3-01	90	C/HLD 225-1	102	
Magnesium (Elements by ICP HNO ₃ /HClO ₄ Ashing)	NIOSH 7300	1455	10 mg/m ³ (fume, as oxide)	5-67		1000-4000		varies		ICP-AES	F/CST 225-3-01	90	C/HLD 225-1	102	
Magnesium oxide (as Mg, elements by ICP)	NIOSH 7303		10	5-33000		1000-4000		varies		ICP-AES	F/CST 225-3-01	90	C/HLD 225-1	102	
Magnesium oxide fume (respirable dust)	OSHA ID 121	1214	5 mg/m ³	960		2000		8		GR & AA or GR & AES	F/CST 225-3-01 CYC 225-105	90 110	C/HLD 225-1	102	
Magnesium oxide fume (total dust)	OSHA ID 121	1213	15 mg/m ³	960		2000		8		AA or AES	F/CST 225-3-01	90	C/HLD 225-1	102	
Malathion	ASTM D 4861			240-7200		1000-5000		4-24		GC-NPD	PUF 226-92	44			
Malathion	OSHA 62	1397	15 mg/m ³	60		1000		1		GC-FPD	ST 226-30-16	38			
Malathion (Organophosphorus Pesticides)	NIOSH 5600		10 mg/m ³	60		1000		1		GC-FPD	ST 226-58	39			
Malbranchea species (fungi, molds, spores)	OSHA CSI			120		1000		2		F/CST	225-3-01	90	C/HLD 225-1	102	
Malbranchea species (fungi, molds, spores)	OSHA CSI			141.5		28300		5 min		varies	BI 225-9611	120			
Maleic anhydride	EPA TO-17	1689		1 L & 4 L		16.7 ml/min & 66.7 ml/min				TD, GC	ST 226-300 Series CPC 224-26-CPC	42 51	TH 224-26-02	51	
Maleic anhydride	NIOSH 3512		0.25	360		1000		6		HPLC-UV	IMP 225-36-2	67	IT 225-22	67	
Maleic anhydride	OSHA 25		0.25	20		100		3.3		HPLC-UV	ST 226-30-07	38	ST 226-30	38	
Maleic anhydride	OSHA 86		0.25	60		500		2		HPLC-UV	CF/CST 225-9021 ††	64	C/HLD 225-1	102	
Maneb	OSHA 107			500		2000		250		HPLC-UV	F/CST 225-3-01	90	C/HLD 225-1	102	
Maneb	OSHA CSI									W	225-2401A	140			
Manganese & compounds (as Mn)	OSHA ID 121	1194	5 mg/m ³ (C)	960	10	2000	2000	8	5	AA or AES	F/CST 225-3-01	90	C/HLD 225-1	102	
Manganese & compounds (as Mn)	OSHA ID 125G		5 mg/m ³		10		2000		5	ICP-AES	F/CST 225-3-01 C/HLD 225-803	or 102	F/CST 225-3100 or F/CST 225-8215	or 93	
Manganese (Elements by Cellulosic Internal Capsule Sampler)	NIOSH 7306		1 mg/m ³ 3 mg/m ³	1-1000		1000-4000		Varies		ICP-AES	SC 225-8517	90	C/HLD 225-1	102	
Manganese (Elements by ICP Aqua Regia Ashing)	NIOSH 7301		1 mg/m ³ 3 mg/m ³	5-200 5-200		1000-4000 1000-4000		varies varies		ICP-AES	F/CST 225-3-01 C/HLD 225-1	or 102	F/CST 225-803	¥ 93	
Manganese (Elements by ICP HNO ₃ Digestion)	NIOSH 7303		1 mg/m ³ 3 mg/m ³	0.05-10,000 0.05-10,000		1000-4000 1000-4000		varies varies		ICP-AES	F/CST 225-3-01	90	C/HLD 225-1	102	
Manganese (Elements by ICP HNO ₃ /HClO ₄ Ashing)	NIOSH 7300	1455	1 mg/m ³ 3 mg/m ³	5-200 5-200		1000-4000 1000-4000		varies varies		ICP-AES	F/CST 225-3-01	90	C/HLD 225-1	102	
Manganese (Elements on Wipes)	NIOSH 9102			wipe						ICP-AES	W 225-2414 TMP 225-2415	140 140	TMP 225-2403	or	
Manganese cyclopentadienyl tricarbonyl (as Mn)	OSHA CSI			480		1000		8		AA	F/CST 225-3-01 IT 225-22	90 67	IMP 225-36-2	67	
Manganese fume	OSHA ID 125G		5 mg/m ³	480	30	2000	2000	4	15	ICP-AES	F/CST 225-3-01 C/HLD 225-803	or 102	F/CST 225-3100 or F/CST 225-8215	or 93	
Manganese fume (as Mn)	OSHA ID 121	1195	5 mg/m ³ (C)	960	10	2000	2000	8	5	AA or AES	F/CST 225-3-01	90	C/HLD 225-1	102	
Manganese in welding fume	NON 58		5 mg/m ³	varies		750		varies		GR	FLT 225-8050 C/HLD 225-6200		CST 225-6201		
Manganese tetroxide (as Mn)	OSHA ID 121	1191		960		2000		8		AA or AES	F/CST 225-3-01	90	C/HLD 225-1	102	
Manganese tetroxide (as Mn)	OSHA ID 125G			480		2000		4		ICP-AES	F/CST 225-3-01 C/HLD 225-803	or 102	F/CST 225-3100 or F/CST 225-8215	or 93	

Agency standards for OSHA listings represent the OSHA PELs reported in the 29 CFR 1910.1000 Part 1910, Section 1000.

References and abbreviations are found on pages 212-213.

Chemical Hazard	Agency Reference	Chem F File	SAMPLING ∞								Analytical Method	SKC Collecting Equipment & Page Number							
			Agency Standard		Vol. (liter)		Rate (ml/min)		Time										
			TWA (ppm)	CLG/STEL (ppm)	TWA (Sample Time or Air Volume)	CLG/STEL	TWA (Flow/Sampling Rate)	CLG/STEL	TWA (hrs)	CLG/STEL (min)									
Marble (particulates, respirable)	NIOSH 0600	1038			375			2500			2.5		GR	FLT CYC	225-5-37-P 225-01-02	93 111	C/HLD CST	225-1 225-3LF	102 97
Marble (particulates, total)	NIOSH 0500	1035			120			2000			1		GR	FLT CST	225-5-37-P 225-2LF	93 97	C/HLD	225-1	102
Marble (see dust, total and respirable nuisance)																			
MCPA (2-methyl-4-chlorophenoxyacetic acid)	OSHA CSI				240			500			8		HPLC	F/CST	225-706	96	C/HLD	225-1	102
MCPPP	OSHA CSI				240			1000			4		HPLC-UV	F/CST	225-706	96	C/HLD	225-1	102
MDI (4,4-methylene bisphenyl isocyanate)	OSHA 47		50 µg/m³	200 µg/m³		10		1000			10		HPLC-UV	CF/CST C/HLD	225-9002 225-1	or 102	CF/CST	225-9013	64
MDI (4,4-methylenebis(phenyl isocyanate)) (isocyanates, total)	NIOSH 5525		50 µg/m³	200 µg/m³ (10 min) C	1-500			1000-2000			varies		HPLC-UV	FLT SP FLT	225-7 ‡ 225-27 225-702 ‡	96 or 96	CST IOM	225-4 225-76A	97 108
MDI (4,4'-methylenebisphenyl isocyanate) (isocyanates)	NIOSH 5521	1001	50 µg/m³	200 µg/m³ (10 min) C	480	10		1000	1000		8	10	HPLC-ELCHM & HPLC-UV	IMP	225-36-1	67	IT	225-22	67
MEK (see methyl ethyl ketone)																			
Melamine	OSHA CSI				40			1000			40 min		HPLC	F/CST	225-709	96	C/HLD	225-1	102
Melengestrol acetate	OSHA CSI				120			1000			2		HPLC-UV	F/CST	225-706	96	C/HLD	225-1	102
Menadione	OSHA CSI				10			20(50)			8(3.3)		HPLC-UV	ST	226-30	38			
Mercaptans (see specific compounds)	NIOSH 2542	1330		0.5 (15 min)	48	12		100	200		8	60	GC-FPD	CF/CST	225-9007	64	C/HLD	225-1	102
Mercaptoethanol	OSHA CSI				10			20(50)			8(3.3)		GC-FPD	ST	226-10	38			
Mercury	NIOSH 6009		0.05 mg/m³		48			200			4		AA	ST	226-17-1A	38	F/CST	225-3-01	90
Mercury (Rathje & Marcero)	NON 17				48			100			8		AA	ST	226-17-1A	38			
Mercury (Rathje & Marcero)	NON 17				varies			1000-3000			varies		AA	ST	226-17-3A	38			
Mercury (vapor)	OSHA ID 140	1677	0.1 mg/m³		3-100			200			varies		AA	ST	226-17-1A	38	F/CST	225-3-01	90
Mercury (vapor)	OSHA ID 140	1677	0.1 mg/m³		9.6			20			8		AA	CH	520-03	86	C	520-02A	86
Mercury, Particulate (in Workplace Atmospheres, air samples)	OSHA ID 145			0.01 mg/m³		30						15	AA	F/CST	225-3-01	90	C/HLD	225-1	102
Mercury, Particulate (in Workplace Atmospheres, wipe samples)	OSHA ID 145			0.01 mg/m³									wipe	SM TB	225-24	140			
Mesityl oxide	OSHA 07	1144	25		10	3		20(50)	200		8(3.3)	15	GC-FID	ST	226-01	38			
Mesityl oxide (Ketones II)	NIOSH 2553		10		1-25			10-200			varies		GC-FID	ST	NA SKC				
Mesityl oxide (Ketones II)	NIOSH 1301		10		10			20(50)			8(3.3)		GC-FID	ST	226-01	38			
Mesitylene	EPA TO-17	1689			1 L & 4 L			16.7 ml/min & 66.7 ml/min					TD, GC	ST CPC	226-300 Series 224-26-CPC	42 51	TH	224-26-02	51
Mestranol	OSHA PV2068				480			2000			4		HPLC	F/CST	225-802	93	C/HLD	225-1	102
Metal & metalloid particulates	OSHA ID 121	1177	varies	varies	960	30		2000	2000		8	15	AA or AES	F/CST	225-3-01	90	C/HLD	225-1	102
Metal & metalloid particulates	OSHA ID 125G	1371	varies	varies	480	30		2000	2000		4	15	ICP-AES	F/CST F/CST C/HLD	225-3-01 225-803 225-1	or or	F/CST F/CST	225-3100 225-8215	93 93
Metal removal fluid (aerosol)	ASTM D 7049				960			2000			8		GR	FLT C/HLD	225-27-07 225-1	94	CST	225-2LF	97
Metal working fluids (aerosols)	ASTM D 7049				960			2000			8		GR	FLT C/HLD	225-27-07 225-1	94	CST	225-2LF	97
Metals (in settled dust)	ASTM D 6966				wipe			wipe			wipe		Varies	W TMP	225-2414 225-2415	140 140	TMP	225-2403	or
Metals in workplace atmospheres	ASTM D 4185	1426			varies			2000			varies		AAS	F/CST	225-3-01	90	C/HLD	225-1	102
Metals, trace (Elements by ICP HNO ₃ /HClO ₄ , Ashing)	NIOSH 7300	1455	varies	varies	varies	varies		1000-4000	1000-4000		varies	varies	ICP-AES	F/CST	225-3-01	90	C/HLD	225-1	102
Metalworking fluids (thoracic particulates)	NIOSH 5524 ●		0.4 mg/m³ (thoracic particulates)		2000			varies			varies		GR	PPI IS SCN	225-381 225-388 225-26	112 95 103	FLT SP	225-27-07 225-27	94 or
Metalworking fluids (total particulates)	NIOSH 5524 ●	1726	0.5 mg/m³ (total particulates)		1000 (min)			2000			varies		GR	FLT C/HLD	225-27-07 225-1	94	CST	225-4	97
Methacrylic acid	OSHA PV2005				24			100			4		HPLC-UV	ST	226-30-08	38			
Metham sodium	OSHA CSI				40			1000			40 min		HPLC-UV	ST	226-58	39			
Methamidophos	OSHA CSI				480			1000			8		GC-FPD	ST	226-30-16	38			
Methamidophos (Organophosphorus Pesticides)	NIOSH 5600				240			1000			4		GC-FPD	ST	226-58	39			
Methanol (methyl alcohol)	EPA TO-17	1689			1 L & 4 L			16.7 ml/min & 66.7 ml/min					TD, GC	ST CPC	226-300 Series 224-26-CPC	42 51	TH	224-26-02	51
Methanol (methyl alcohol)	NIOSH 2000		200	250	5	3		20	200		4	15	GC-FID	ST	226-51	39			
Methidathion	OSHA PV2074				60			1000			1		GC-ECD	ST	226-58	39			
Methiocarb (Organonitrogen Pesticides)	NIOSH 5601				240			1000			4		HPLC-UV	ST	226-58	or	ST	226-30-16	38
Methomyl	OSHA PV2114				60			1000			1		HPLC-UV	ST	226-30-16	38			
Methomyl (Organonitrogen Pesticides)	NIOSH 5601		2.5 mg/m³		240			1000			4		HPLC-UV	ST	226-58	or	ST	226-30-16	38
Methotrexate	OSHA PV2146				120			1000			2		HPLC-UV	ST	226-30-16	38			

M

Agency standards for OSHA listings represent the OSHA PELs reported in the 29 CFR 1910.1000 Part 1910, Section 1000.

References and abbreviations are found on pages 212-213.

Sampling Guide

www.skinc.com for updates

M

Chemical Hazard	Agency Reference	Chem F File	SAMPLING ∞								Analytical Method	SKC Collecting Equipment & Page Number				
			Agency Standard		Vol. (liter)		Rate (ml/min)		Time							
			TWA (ppm)	CLG/STEL (ppm)	TWA	CLG/STEL	TWA	CLG/STEL	TWA (hrs)	CLG/STEL (min)						
2-Methoxy-1-propanol	OSHA 99			10		100		100 min		GC-FID	ST 226-01	38				
2-Methoxy-1-propyl acetate	OSHA 99			10		100		100 min		GC-FID	ST 226-01	38				
1-Methoxy-2-propanol	OSHA 99			10		100		100 min		GC-FID	ST 226-01	38				
1-Methoxy-2-propanol (glycol ethers)	NIOSH 2554			3-25		100-200		varies		GC-FID	ST 226-81A	39				
1-Methoxy-2-propyl acetate	OSHA 99			10		100		100 min		GC-FID	ST 226-01	38				
1-Methoxy-2-propyl acetate (glycol ethers)	NIOSH 2554			3-25		100-200		varies		GC-FID	ST 226-81A	39				
Methoxychlor	ASTM D 4861				240-7200		1000-5000	4-24		GC-ECD	PUF 226-92	44				
Methoxychlor	OSHA PV2038		15 mg/m ³		60		1000	1		GC-ECD	ST 226-30-16	38				
2-Methoxyethanol	EPA TO-17	1689			1 L & 4 L		16.7 ml/min & 66.7 ml/min			TD, GC	ST 226-300 Series CPC 224-26-CPC	42 51	TH	224-26-02	51	
2-Methoxyethanol (methyl CELLOSOLVE solvent)	OSHA 79	1277	25	48	15	100	1000	8	15	GC-FID	ST 226-01	38				
2-Methoxyethanol (methyl CELLOSOLVE solvent) (alcohols IV)	NIOSH 1403	1274	0.1 (skin)	6-50		10-50		varies		GC-FID	ST 226-01	38				
2-Methoxyethyl acetate	EPA TO-17	1689			1 L & 4 L		16.7 ml/min & 66.7 ml/min			TD, GC	ST 226-300 Series CPC 224-26-CPC	42 51	TH	224-26-02	51	
2-Methoxyethyl acetate (methyl CELLOSOLVE acetate)	OSHA 79	1277	25	48	15	100	1000	8	15	GC-FID	ST 226-01	38				
Methoxyflurane	OSHA CSI			10		20(50)		8(3.3)		GC-FID	ST 226-01	38				
2-Methoxyphenol	OSHA PV2039			20		200		100 min		GC-FID	ST 226-95	40				
3-Methoxyphenol	OSHA PV2039			20		200		100 min		GC-FID	ST 226-95	40				
4-Methoxyphenol	OSHA PV2039			20		200		100 min		GC-FID	ST 226-95	40				
Methoxypropanol	EPA TO-17	1689			1 L & 4 L		16.7 ml/min & 66.7 ml/min			TD, GC	ST 226-300 Series CPC 224-26-CPC	42 51	TH	224-26-02	51	
6-Methoxytetralone	OSHA CSI			10		20(50)		8(3.3)		HPLC-UV	ST 226-30	38				
Methyl acetate	EPA TO-17	1689			1 L & 4 L		16.7 ml/min & 66.7 ml/min			TD, GC	ST 226-300 Series CPC 224-26-CPC	42 51	TH	224-26-02	51	
Methyl acetate	NIOSH 1458		200	250	5	3	20	200	4	15	GC-FID	ST 226-01	38			
Methyl acetate	OSHA 07	1143	200		5	3	20	200	4	15	GC-FID	ST 226-01	38			
Methyl acetylene-propadiene mixture	OSHA 07	1142	1000		2	0.75	20	50	100 min	15	GC-FID	ST 226-01	38			
Methyl acrylate	EPA TO-17	1689			1 L & 4 L		16.7 ml/min & 66.7 ml/min			TD, GC	ST 226-300 Series CPC 224-26-CPC	42 51	TH	224-26-02	51	
Methyl acrylate	NIOSH 1459		10		5		20		4		GC-FID	ST 226-01	38			
Methyl acrylate	NIOSH 2552		10		1-5		10-200		varies		GC-FID	ST NA SKC				
Methyl acrylate	NON 54		5	15	10	3	20	200	8	15	GC-FID	ST 226-81A	39			
Methyl acrylate	OSHA 92		10		12		50		4		GC-FID	ST 226-73	39			
Methyl acrylonitrile	OSHA 37				20		200		100 min		GC-NPD	ST 226-01	38			
Methyl alcohol (methanol)	EPA TO-17	1689			1 L & 4 L		16.7 ml/min & 66.7 ml/min			TD, GC	ST 226-300 Series CPC 224-26-CPC	42 51	TH	224-26-02	51	
Methyl alcohol (methanol)	NIOSH 2000		200	250	5	3	20	200	4	15	GC-FID	ST 226-51	39			
Methyl alcohol (RH < 50% at 25 C)	OSHA 91	1328	200		3	0.75	50	50	1	15	GC-FID	ST 226-82	40			
Methyl alcohol (RH > 50% at 25 C)	OSHA 91	1328	200		5	0.75	50	50	100 min	15	GC-FID	ST 226-82	40			
Methyl amine	OSHA 40		10		10		20		8		HPLC-UV	ST 226-96	40			
Methyl arsonic acid (arsenic, organo-)	NIOSH 5022				480		1000		8		IC-AA	FLT 225-17-01 C/HLD 225-1	94 102	CST	225-2LF	97
Methyl bromide	ASTM D 5466				6		varies		varies		GC-MS	CAN 228 Series	PK	228 Series		
Methyl bromide	OSHA PV2040		20		3		200		15		GC-FID	ST 226-83	40			
Methyl butyl ketone (Ketones I)	NIOSH 2555				1-10		10-200		varies		GC-FID	ST NA SKC				
Methyl butyl ketone (MBK, 2-hexanone) (Ketones I)	NIOSH 1300		1		10		20(50)		8(3.3)		GC-FID	ST 226-01	38			
Methyl CELLOSOLVE acetate (2-methoxyethyl acetate)	NIOSH 1451		0.1		12		50		4		GC-FID	ST 226-01	38			
Methyl CELLOSOLVE acetate (2-methoxyethyl acetate)	OSHA 79	1277	25	48	15	100	1000	8	15	GC-FID	ST 226-01	38				
Methyl CELLOSOLVE solvent (2-methoxyethanol)	OSHA 79	1277	25	48	15	100	1000	8	15	GC-FID	ST 226-01	38				
Methyl CELLOSOLVE solvent (2-methoxyethanol) (alcohols IV)	NIOSH 1403	1274	0.1 (skin)	6-50		10-50		varies		GC-FID	ST 226-01	38				
Methyl chloride	ASTM D 5466				6		varies		varies		GC-MS	CAN 228 Series	PK	228 Series		
Methyl chloride	NIOSH 1001		LFC		0.5		100		5		GC-FID	ST 226-09	38	ST	226-01	38
Methyl chloroform	ASTM D 5466				6		varies		varies		GC-MS	CAN 228 Series	PK	228 Series		
Methyl chloroform (1,1,1-Trichloroethane)	EPA TO-17	1689			1 L & 4 L		16.7 ml/min & 66.7 ml/min			TD, GC	ST 226-300 Series CPC 224-26-CPC	42 51	TH	224-26-02	51	
Methyl chloroform (1,1,1-trichloroethane)	OSHA 14		350		3	3	20	200	2.5	15	GC-FID	ST 226-01	38			
Methyl chloroform (1,1,1-trichloroethane) (hydrocarbons, halogenated)	NIOSH 1003			350		3		10-200		varies	GC-FID	ST 226-01	38			
Methyl cyclohexane	OSHA 07	1069	500		5		20		4		GC-FID	ST 226-01	38			
Methyl cyclohexane (hydrocarbons, BP 36 to 216 C)	NIOSH 1500		400		4		10-200		varies		GC-FID	ST 226-01	38			

Agency standards for OSHA listings represent the OSHA PELs reported in the 29 CFR 1910.1000 Part 1910, Section 1000.

References and abbreviations are found on pages 212-213.

Chemical Hazard	Agency Reference	Chem F File	SAMPLING ∞								Analytical Method	SKC Collecting Equipment & Page Number							
			Agency Standard		Vol. (liter)		Rate (ml/min)		Time										
			TWA (ppm)	CLG/STEL (ppm)	TWA	CLG/STEL	TWA	CLG/STEL	TWA (hrs)	CLG/STEL (min)									
Methyl demeton	OSHA CSI				480		1000			8		GC-FPD	ST	226-30-16	38				
N-Methyl dicyclohexylamine	OSHA CSI				10		20(50)			8(3.3)		GC-FID	ST	226-10	38				
Methyl ethyl ketone	EPA TO-17	1689			1 L & 4 L		16.7 ml/min & 66.7 ml/min					TD, GC	ST CPC	226-300 Series 224-26-CPC	42 51	TH	224-26-02	51	
Methyl ethyl ketone	OSHA 1004		200		12		50			4		GC-FID	ST	NA SKC					
Methyl ethyl ketone (Ketones I)	NIOSH 2555				1-10		10-200			varies		GC-FID	ST	NA SKC					
Methyl ethyl ketone (MEK) (see 2-butanone)																			
Methyl ethyl ketone (MEK) (see 2-butanone)	NIOSH 2500	1012	200	300	10	3	20(50)	200		8(3.3)	15	GC-FID	ST	226-81A	39				
Methyl ethyl ketone (MEK, 2-butanone)	OSHA 1004		200				16.88			8		GC-FID	PS	575-002	75				
Methyl ethyl ketone peroxide	NIOSH 3508	1002		0.2 (15 min)		120		1000		120		VAS	IMP	225-36-1	67	IT	225-22	67	
Methyl ethyl ketone peroxide	OSHA 77					15		1000		15		HPLC-UV	ST	226-93	40				
Methyl formate	OSHA PV2041		100		3		50			1		GC-FID	ST	226-83	40				
Methyl iodide	NIOSH 1014		2		48		100			8		GC-FID	ST	226-01	38				
Methyl iodide	OSHA CSI		5		50		200			4		GC-FID	ST	226-01	38				
Methyl isoamyl acetate (Esters I)	NIOSH 1450		50		1-10		10-200			varies		GC-FID	ST	226-01	38				
Methyl isoamyl ketone	OSHA PV2042		100		24		50			8		GC-FID	ST	226-01	38				
Methyl isobutyl carbinol (methyl amyl alcohol)	OSHA 07	1068	25		10	3	20(50)	200		8(3.3)	15	GC-FID	ST	226-01	38				
Methyl isobutyl carbinol (methyl amyl alcohol) (alcohols combined)	NIOSH 1405		25	40 (skin)	1-10	1-10	10-200	10-200		varies	varies	GC-FID	ST	226-01	38				
Methyl isobutyl carbinol (methyl amyl alcohol) (Alcohols III)	NIOSH 1402		25	40	10	3	20(50)	200		8(3.3)	15	GC-FID	ST	226-01	38				
Methyl isobutyl ketone	EPA TO-17	1689			1 L & 4 L		16.7 ml/min & 66.7 ml/min					TD, GC	ST CPC	226-300 Series 224-26-CPC	42 51	TH	224-26-02	51	
Methyl isobutyl ketone	OSHA 1004		100		12		50			4		GC-FID	ST	NA SKC					
Methyl isobutyl ketone (hexone)	OSHA 07	1070	100		10		20(50)			8(3.3)		GC-FID	ST	226-01	38				
Methyl isobutyl ketone (hexone)	OSHA 1004		100				13.62			8		GC-FID	PS	575-002	75				
Methyl isobutyl ketone (hexone) (Ketones I)	NIOSH 1300		50	75	10	3	20(50)	200		8(3.3)	15	GC-FID	ST	226-01	38				
Methyl isobutyl ketone (Ketones I)	NIOSH 2555		50		1-10		10-200			varies		GC-FID	ST	NA SKC					
Methyl isocyanate (MIC)	OSHA 54		0.02		15		50			5		HPLC-FD	ST	NA SKC					
Methyl isopropyl ketone	OSHA CSI				10		20			8		GC-FID	ST	226-01	38				
Methyl isothiocyanate	OSHA CSI				120		1000			2		GC-FID	ST	226-01	38				
Methyl mercaptan	NIOSH 2542	1330		0.5 (15 min)	48	12	100	200		8	60	GC-FPD	CF/CST	225-9007	64	C/HLD	225-1	102	
Methyl mercaptan	NON 42	1412			12		1000			12 min		GC-FPD	SB	231-10	54				
Methyl mercaptan	OSHA 26			10	20		200			100 min		GC-FPD	CF/CST	225-9007	64	C/HLD	225-1	102	
Methyl methacrylate	EPA TO-17	1689			1 L & 4 L		16.7 ml/min & 66.7 ml/min					TD, GC	ST CPC	226-300 Series 224-26-CPC	42 51	TH	224-26-02	51	
Methyl methacrylate	NIOSH 2537		100		1-8		10-50			varies		GC-FID	ST	226-30-06	38				
Methyl methacrylate	NON 54		50	75	10	3	20	200		8	15	GC-FID	ST	226-81A	39				
Methyl methacrylate	OSHA 94		100		3		50			1		GC-FID	ST	226-73	39				
4-Methyl morpholine	OSHA CSI				30		100			5		GC-FID	ST	226-98	40				
Methyl n-amyl ketone (2-heptanone) (Ketones II)	NIOSH 2553		100		1-25		10-200			varies		GC-FID	ST	NA SKC					
Methyl parathion	ASTM D 4861				240-7200		1000-5000			4-24		GC-NPD	PUF	226-92	44				
Methyl parathion	OSHA PV2112				480		1000			8		GC-FPD	ST	226-30-16	38				
Methyl parathion (Organophosphorus Pesticides)	NIOSH 5800		0.2 mg/m ³		240		1000			4		GC-FPD	ST	226-58	39				
Methyl propyl ketone (2-pentanone)	OSHA 07		200		10	3	20(50)	200		8(3.3)	15	GC-FID	ST	226-01	38				
Methyl propyl ketone (Ketones I)	NIOSH 2555				1-10		10-200			varies		GC-FID	ST	NA SKC					
Methyl silicate	OSHA CSI				9		50			3		GC-FID	ST	226-30-04	38				
alpha-Methyl styrene	OSHA 07	1066		100 (C)	30	3	200	200		2.5	15	GC-FID	ST	226-01	38				
alpha-Methyl styrene (Hydrocarbons, Aromatic)	NIOSH 1501		50	100	1-30	1-30	10-200	10-200		varies	varies	GC-FID	ST	226-01	38				
beta-Methyl styrene (Hydrocarbons, Aromatic)	NIOSH 1501		50	100	1-30	1-30	10-200	10-200		varies	varies	GC-FID	ST	226-01	38				
Methyl styrene (vinyl toluene)	EPA TO-17	1689			1 L & 4 L		16.7 ml/min & 66.7 ml/min					TD, GC	ST CPC	226-300 Series 224-26-CPC	42 51	TH	224-26-02	51	
17-a-Methyl testosterone	OSHA PV2001				60		1000			1		HPLC-UV	F/CST	225-706	96	C/HLD	225-1	102	
Methyl-2-cyanoacrylate	OSHA 55				12		100			2		HPLC-UV	ST	226-98	40				
3-Methyl-2-cyclopentene-2-ol-one	OSHA CSI				10		200			50 min		HPLC-UV	ST	226-30-04	38				
1-Methyl-2-ethyl benzene	EPA TO-17	1689			1 L & 4 L		16.7 ml/min & 66.7 ml/min					TD, GC	ST CPC	226-300 Series 224-26-CPC	42 51	TH	224-26-02	51	
1-Methyl-2-pyrrolidinone	OSHA PV2043				10		200			50 min		GC-FID	ST	226-01	38				
N-Methyl-2-pyrrolidinone	NIOSH 1302				96		200			8		GC-NPD, FID	ST	226-01	38				
N-Methyl-2-pyrrolidinone	OSHA PV2043				10		200			50 min		GC-FID	ST	226-01	38				

M

Agency standards for OSHA listings represent the OSHA PELs reported in the 29 CFR 1910.1000 Part 1910, Section 1000.

References and abbreviations are found on pages 212-213.

Sampling Guide

www.skinc.com for updates

M

Chemical Hazard	Agency Reference	Chem F File	SAMPLING ∞								Analytical Method	SKC Collecting Equipment & Page Number							
			Agency Standard		Vol. (liter)		Rate (ml/min)		Time										
			TWA (ppm)	CLG/STEL (ppm)	TWA (Sample Time or Air Volume)	CLG/STEL	TWA (Flow/Sampling Rate)	CLG/STEL	TWA (hrs)	CLG/STEL (min)									
1-Methyl-3-ethyl benzene	EPA TO-17	1689			1 L & 4 L		16.7 ml/min & 66.7 ml/min					TD, GC	ST CPC	226-300 Series 224-26-CPC	42 51	TH	224-26-02	51	
5-Methyl-3-heptanone (ketones II)	NIOSH 2553		25		1-25		10-200		varies			GC-FID	ST	NA SKC					
5-Methyl-3-heptanone (ketones II)	NIOSH 1301		25		10		20(50)		8(3.3)			GC-FID	ST	226-01				38	
1-Methyl-4-ethyl benzene	EPA TO-17	1689			1 L & 4 L		16.7 ml/min & 66.7 ml/min					TD, GC	ST CPC	226-300 Series 224-26-CPC	42 51	TH	224-26-02	51	
2-Methyl-4-isothiazolin-3-one (Kathon 886)	NON 55		1.5 mg/m ³	4.5 mg/m ³	50	7.5	200	500	4	15		HPLC-UV	ST	226-99				40	
Methylacetylene (propyne)	OSHA CSI		1000		2		50		40 min			GC-FID	ST	226-01				38	
Methylal (dimethoxymethane)	NIOSH 1611		1000		1.8		20		1.5			GC-FID	ST	226-01				38	
Methylal (see dimethoxymethane)																			
6-Methylcoumarin	OSHA CSI				10		20(50)		8(3.3)			HPLC-UV	ST	226-30				38	
Methylcyclohexanol	NIOSH 1404		50		12		25		8			GC-FID	ST	226-01				38	
Methylcyclohexanol	OSHA CSI		100		12		25		8			GC-FID	ST	226-01				38	
Methylcyclohexanone	NIOSH 2521		50	75	3		50		1			GC-FID	ST	226-115				40	
o-Methylcyclohexanone	OSHA CSI		100		6	0.75	50	50	2	15		GC-FID	ST	226-115				40	
Methylcyclopentadienyl manganese tricarbonyl (as Mn)	OSHA CSI			5 (C)	10		200		1			AA	ST	226-30				38	
N-Methyldiethanolamine	OSHA CSI				20		100		3.3			GC-NPD	ST	226-42-02				39	
4,4'-Methylene bisphenyl isocyanate (MDI)	OSHA 47	1242		200 µg/m ³		15		1000		15		HPLC-UV	CF/CST C/HLD	225-9002 225-1	or 102	CF/CST	225-9013	64	
4,4'-Methylene bisphenyl isocyanate (MDI) (isocyanates)	NIOSH 5521	1001	50 µg/m ³	200 µg/m ³ (10 min) C	480	10	1000	1000	8	10		HPLC- ELCHM & HPLC-UV	IMP	225-36-1		67	IT	225-22	67
4,4'-Methylene bisphenyl isocyanate (MDI) (isocyanates)	OR-OSHA 1010		0.02	0.005	45	5	1000	1000	45 min	5		HPLC	IMP CF/CST	225-36-1 225-9029		67 64	IT	225-22	67
Methylene chloride	NIOSH 1005	1018	LFC		2	1.5	20	100	1.6	15		GC-FID	ST	226-01				38	
Methylene chloride	OSHA 59	1358	25	125	10	0.25	50	50	3.3	5		GC-FID	ST	226-09-02				38	
Methylene chloride	OSHA 80		25	125	3	0.25	50	50	1	5		GC-FID	ST	NA SKC					
Methylene chloride (dichloromethane)	EPA TO-17	1689			1 L & 4 L		16.7 ml/min & 66.7 ml/min					TD, GC	ST CPC	226-300 Series 224-26-CPC	42 51	TH	224-26-02	51	
4,4'-Methylene diphenyl isocyanate (MDI)	NIOSH 5522		50 µg/m ³	200 µg/m ³ (10 min) C	360	20	1000	2000	6	10		HPLC-FD	IMP	225-36-1		67	IT	225-22	67
4,4'-Methylenebis(2-chloroaniline) (MOCA)	OSHA 71	1234			100		1000		100 min			GC-ECD	CF/CST	225-9004		64	C/HLD	225-1	102
2,2'-Methylene-bis(4-chlorophenol)	OSHA CSI				750		2000		6.25			HPLC-UV	F/CST	225-709		96	C/HLD	225-1	102
Methylene-bis-(4-cyclohexylisocyanate)	OSHA PV2092					15		1000		15		HPLC-UV	CF/CST	225-9013		64	C/HLD	225-1	102
Methylene-bis-(4-cyclohexylisocyanate) (isocyanates, total)	NIOSH 5525			110 µg/m ³ (10 min) C		1-500		1000-2000		varies		HPLC-UV	FLT SP FLT	225-7 ‡ 225-27 225-702 ‡		96 or 96	CST IOM	225-4 225-76A	97 108
4,4'-Methylenebisphenyl isocyanate (MDI) (isocyanates, total)	NIOSH 5525		50 µg/m ³	200 µg/m ³ (10 min) C	1-500		1000-2000		varies			HPLC-UV	FLT SP FLT	225-7 ‡ 225-27 225-702 ‡		96 or 96	CST IOM	225-4 225-76A	97 108
4,4'-Methylenedianiline (MDA)	NIOSH 5029		LFC		480		1000		8			HPLC-UV	CF/CST	225-9004		64	C/HLD	225-1	102
4,4'-Methylenedianiline (MDA)	OSHA 57	1240			100		1000		100			GC-ECD	CF/CST	225-9004		64	C/HLD	225-1	102
Methyl-n-amyl ketone (2-heptanone)	OSHA CSI		100		24		200		2			GC-FID	ST	226-01				38	
Methyl-n-amyl ketone (2-heptanone) (Ketones II)	NIOSH 1301		100		10		20(50)		8(3.3)			GC-FID	ST	226-01				38	
5-Methyl-o-anisidine	OSHA CSI				60		1000		1			HPLC-UV	ST	226-30-04				38	
2-Methylpentane	OSHA CSI				10		20(50)		8(3.3)			GC-FID	ST	226-01				38	
3-Methylpentane	OSHA CSI				5		20		4			GC	ST	226-01				38	
Methylphenols	EPA TO-8	1668			< 80 L		100-1000 ml/min					HPLC-UV	IMP	225-36-1		67	IT	225-22	67
Methyl-t-butyl-ether (MTBE)	EPA TO-17	1689			1 L & 4 L		16.7 ml/min & 66.7 ml/min					TD, GC	ST CPC	226-300 Series 224-26-CPC	42 51	TH	224-26-02	51	
Methyl-tert-butyl ether	NIOSH 1615	1017			96		200		8			GC-FID	ST	226-37				39	
Methyltetrahydrophthalic anhydride	NON 28				200	20	40	1000	8	20		GC-FID	ST	226-30				38	
Methyltin dichloride	NIOSH 5526		0.1 mg/m ³		60	60	250	1000	4	60		GC-FPD	ST	226-30-16				38	
Methyltin mercaptide (tin, organic compounds [as Sn])	OSHA CSI				480		1000		8			AA-GF	ST	226-30-16				38	
Metolachlor	ASTM D 4861				240-7200		1000-5000		4-24			GC-ECD	PUF	226-92				44	
Metolachlor	NIOSH 5602				480		1000		8			GC-ECD	ST	226-58				39	
Metribuzin	OSHA PV2044				240		1000		4			GC-FPD	ST	226-30-16				38	
Mevinphos (phosdrin)	OSHA CSI		0.1 mg/m ³		480	15	1000	1000	8	15		GC-FPD	ST	226-30-16				38	
Mevinphos (phosdrin) (Organophosphorus Pesticides)	NIOSH 5600		0.01		240		1000		4			GC-FPD	ST	226-58				39	
Mexacarbate	ASTM D 4861				240-7200		1000-5000		4-24			GC-ECD	PUF	226-92				44	
MIBK (see methyl isobutyl ketone)																			
MIC (methyl isocyanate)	OSHA 54		0.02		15		50		5			HPLC-FD	ST	NA SKC					
Mica (see Respirable dust)	OSHA ID 142																		
Mineral spirits (naphthas)	NIOSH 1550		350 mg/m ³	1800 mg/m ³	3	1	20	200	2.5	5		GC-FID	ST	226-01				38	

Agency standards for OSHA listings represent the OSHA PELs reported in the 29 CFR 1910.1000 Part 1910, Section 1000.

References and abbreviations are found on pages 212-213.

Chemical Hazard	Agency Reference	Chem F File	SAMPLING ∞								Analytical Method	SKC Collecting Equipment & Page Number						
			Agency Standard		Vol. (liter)		Rate (ml/min)		Time									
			TWA (ppm)	CLG/STEL (ppm)	TWA (Sample Time or Air Volume)	CLG/STEL	TWA (Flow/Sampling Rate)	CLG/STEL	TWA (hrs)	CLG/STEL (min)								
Mineral wool fiber	OSHA CSI				960		2000			8		GR	FLT CST	225-5-37-P 225-2LF	93 97	C/HLD	225-1	102
Mineral wool fiber (particulates, respirable)	NIOSH 0600	1038			375		2500			2.5		GR	FLT CYC	225-5-37-P 225-01-02	93 111	C/HLD	225-1 225-3LF	102 97
Mineral wool fiber (particulates, total)	NIOSH 0500	1035			120		2000			1		GR	FLT CST	225-5-37-P 225-2LF	93 97	C/HLD	225-1	102
Mirex	ASTM D 4861				240-7200		1000-5000			4-24		GC-ECD	PUF	226-92				44
MOCAP	OSHA CSI				480		1000			8		GC-FPD	ST	226-30-16				38
Mold spores (in air)					15-150		15000			1-10 min		varies	STC	225-9820				101
Molybdenum (Elements by Cellulosic Internal Capsule Sampler)	NIOSH 7306				1-330		1000-4000			Varies		ICP-AES	SC	225-8517		C/HLD	225-1	102
Molybdenum (Elements by ICP Aqua Regia Ashing)	NIOSH 7301			5 mg/m ³ (soluble) 10 mg/m ³ (insoluble)	5-67		1000-4000			varies		ICP-AES	F/CST C/HLD	225-3-01 225-1	or 102	F/CST	225-803	93
Molybdenum (Elements by ICP HNO ₃ Digestion)	NIOSH 7303			5 mg/m ³ (soluble) 10 mg/m ³ (insoluble)	0.5-10,000		1000-4000			varies		ICP-AES	F/CST	225-3-01		C/HLD	225-1	102
Molybdenum (Elements by ICP HNO ₃ /HClO ₄ Ashing)	NIOSH 7300	1455		5 mg/m ³ (soluble) 10 mg/m ³ (insoluble)	6-67		1000-4000			varies		ICP-AES	F/CST	225-3-01		C/HLD	225-1	102
Molybdenum (Elements on Wipes)	NIOSH 9102			wipe								ICP-AES	W TMP	225-2414 225-2415	140 140	TMP	225-2403	or
Molybdenum insolubles (as Mo)	OSHA ID 125G			15 mg/m ³	480		2000			4		ICP-AES	F/CST F/CST C/HLD	225-3-01 225-803 225-1	or or	F/CST F/CST	225-3100 225-8215	93 93
Molybdenum insolubles (as Mo) (respirable fraction)	OSHA ID 121	1212		15 mg/m ³ (total dust)	960		2000			8		GR & AA or GR & AES	F/CST CYC	225-3-01 225-105	90 110	C/HLD	225-1	102
Molybdenum solubles (as Mo)	OSHA ID 121	1211		5 mg/m ³	960		2000			8		AA or AES	F/CST	225-3-01		C/HLD	225-1	102
Monensin	OSHA CSI				960		2000			8		CLR	F/CST	225-706		C/HLD	225-1	102
Monilia species (fungi, molds, spores)	OSHA CSI				120		1000			2		varies	F/CST	225-3-01		C/HLD	225-1	102
Monilia species (fungi, molds, spores)	OSHA CSI				141.5		28300			5 min		varies	BI	225-9611				120
Monochloroacetic acid	OSHA CSI				96		200			8		IC	ST	226-47-01				39
Monochloroacetic acid (chloroacetic acid)	NIOSH 2008				48		100			8		IC-CD	ST	226-47-01				39
Monocrotophos (Azodrin)	OSHA PV2045				480		1000			8		GC-FPD	ST	226-30-16				38
Monocrotophos (Organophosphorus Pesticides)	NIOSH 5600			0.25 mg/m ³	240		1000			4		GC-FPD	ST	226-58				39
Monoethanolamine (2-aminoethanol)	NIOSH 3509		3	6	240		1000			4		IC	IMP	225-36-1		IT	225-22	67
Monoethanolamine (see 2-aminoethanol)																		
Monomethyl aniline	NIOSH 3511			0.5	100		1000			100 min		GC-FID	IMP	225-36-2		IT	225-22	67
Monomethyl aniline	OSHA CSI			2	100		1000			100 min		GC-FID	IMP	225-36-2		IT	225-22	67
Monomethyl hydrazine	NIOSH 3510			0.04 (120 min)	15		1000			15		VAS	IMP	225-36-2		IT	225-22	67
Monomethyl hydrazine	OSHA 20			0.2	4.5		300			15		HPLC-UV	ST	226-42-02				39
Monuron	ASTM D 4861				240-7200		1000-5000			4-24		HPLC-UV	PUF	226-92				44
Morpholine	OSHA PV2123		20		10		100			100 min		GC-FID	ST	226-98				40
Mortierella species (fungi, molds, spores)	OSHA CSI				120		1000			2		varies	F/CST	225-3-01		C/HLD	225-1	102
Mortierella species (fungi, molds, spores)	OSHA CSI				141.5		28300			5 min		varies	BI	225-9611				120
Mucor (fungi, molds, spores)	OSHA CSI				120		1000			2		varies	F/CST	225-3-01		C/HLD	225-1	102
Mucor (fungi, molds, spores)	OSHA CSI				141.5		28300			5 min		varies	BI	225-9611				120
Mycobacteria	NIOSH 0801				50-300		28300			varies		GC-FID	BI	225-9611				120
Mycobacterium tuberculosis (airborne)	NIOSH 0900				1920		4000			8		PCR	FLT CST	225-2705 225-3LF	94 97	SP C/HLD	225-27 225-1	103 102
Mycotoxins (fungi in air)	NON 48				62.5-375		12500 +			5-30		varies	BS	225-9595		VT	225-9595A	122
Naphtha (coal tar)	NIOSH 1550			100	10		20(50)			8(3.3)		GC-FID	ST	226-01				38
Naphtha (coal tar)	OSHA 48				100		200			15 min		GC-FID	ST	226-01				38
Naphthalene	OSHA 35	1060		10	10	3	20(50)	200		8(3.3)	15	GC-FID	ST	226-110				40
Naphthalene (Polynuclear Aromatic Hydrocarbons by GC-MS)	ASTM D 6209				350 m ³ (max)		225 L/min			1-24		GC-MS	PUF	226-131		FLT	225-1808	95
Naphthalene (Polynuclear Aromatic Hydrocarbons by GC)	NIOSH 5515				480		2000			4		GC-FID	F/CST C/HLD	225-1713 225-1	94 102	ST	226-30-04	38
Naphthalene (Polynuclear Aromatic Hydrocarbons by HPLC)	NIOSH 5506			10	15		480			4		HPLC-UV	F/CST C/HLD	225-1713 225-1	94 102	ST	226-30-04	38
1,5-Naphthalene diisocyanate	OSHA PV2046				60		1000			1		HPLC-UV-FD	CF/CST	225-9013		C/HLD	225-1	102
1,5-Naphthalene diisocyanate (isocyanates, total)	NIOSH 5525			40 µg/m ³ 70 µg/m ³ (10 min) C	1-500	1-500	1000-2000	1000-2000		varies	varies	HPLC-UV	FLT SP FLT	225-7 ‡ 225-27 225-702 ‡	96 or 96	CST IOM	225-4 225-76A	97 108
Naphthas (see specific compounds)	NIOSH 1550			varies	varies		varies			8		GC-FID	ST	226-01				38
beta-Naphthol	OSHA CSI				60		1000			1		HPLC-UV	IMP	225-36-1		IT	225-22	67
alpha-Naphthylamine	OSHA 93	1232			100		1000			100 min		GC-ECD	CF/CST	225-9004		C/HLD	225-1	102

M

Agency standards for OSHA listings represent the OSHA PELs reported in the 29 CFR 1910.1000 Part 1910, Section 1000.

References and abbreviations are found on pages 212-213.

Sampling Guide

www.skinc.com for updates

N

Chemical Hazard	Agency Reference	Chem F File	SAMPLING ∞								Analytical Method	SKC Collecting Equipment & Page Number			
			Agency Standard		Vol. (liter)		Rate (ml/min)		Time						
			TWA (ppm)	CLG/STEL (ppm)	TWA (Sample Time or Air Volume)	CLG/STEL	TWA (Flow/Sampling Rate)	CLG/STEL	TWA (hrs)	CLG/STEL (min)					
beta-Naphthylamine	OSHA 93	1232		100		1000		100 min		GC-ECD	CF/CST 225-9004	64	C/HLD 225-1	102	
Naphthylamines (alpha- & beta-)	NIOSH 5518			96		200		8		GC-FID	FLT 225-16 ST 226-51	96 39	CST 225-32	102	
Naphthylene diisocyanate (NDI) (isocyanates)	NIOSH 5521		40 µg/m³ 70 µg/m³ (10 min) C	480	10	1000	1000	8	10	HPLC- ELCHM & HPLC-UV	IMP 225-36-1	67	IT 225-22	67	
Naphthylthiourea (see ANTU)															
Neurospora species (fungi, molds, spores)	OSHA CSI			120		1000		2		varies	F/CST 225-3-01	90	C/HLD 225-1	102	
Neurospora species (fungi, molds, spores)	OSHA CSI			141.5		28300		5 min		varies	BI 225-9611	120			
Nickel (Elements by Cellulosic Internal Capsule Sampler)	NIOSH 7306		0.015 mg/m³	2-2000		1000-4000		Varies		ICP-AES	SC 225-8517	90	C/HLD 225-1	102	
Nickel (Elements by ICP Aqua Regia Ashing)	NIOSH 7301		0.015 mg/m³	5-1000		1000-4000		varies		ICP-AES	F/CST 225-3-01 C/HLD 225-1	or 102	F/CST 225-803	93	
Nickel (Elements by ICP HNO ₃ Digestion))	NIOSH 7303		0.012 mg/m³	1-50,000		1000-4000		varies		ICP-AES	F/CST 225-3-01	90	C/HLD 225-1	102	
Nickel (Elements by ICP HNO ₃ /HClO ₄ Ashing)	NIOSH 7300	1455	0.15 mg/m³	5-1000		1000-4000		varies		ICP-AES	F/CST 225-3-01	90	C/HLD 225-1	102	
Nickel (Elements on Wipes)	NIOSH 9102			wipe						ICP-AES	W 225-2414 TMP 225-2415	140 140	TMP 225-2403	or	
Nickel (metal & insoluble compounds as Ni)	OSHA ID 125G		1 mg/m³	480		2000		4		ICP-AES	F/CST 225-3-01 F/CST 225-803 C/HLD 225-1	or 102	F/CST 225-3100 F/CST 225-8215	or 93	
Nickel (metal, soluble, & insoluble compounds as Ni)	OSHA ID 121	1044	1 mg/m³	960		2000		8		AA or AES	F/CST 225-3-01	90	C/HLD 225-1	102	
Nickel (soluble compounds as Ni)	OSHA ID 121	1197	1 mg/m³	960		2000		8		AA or AES	F/CST 225-3-01	90	C/HLD 225-1	102	
Nickel (soluble compounds as Ni)	OSHA ID 125G		1 mg/m³	480		2000		4		ICP-AES	F/CST 225-3-01 F/CST 225-803 C/HLD 225-1	or 102	F/CST 225-3100 F/CST 225-8215	or 93	
Nickel carbonyl	NIOSH 6007		0.001	72		150		8		AA-GF	ST NA SKC		F/CST 225-3-01	90	
Nickel carbonyl	OSHA CSI		0.001	480		1000		8		AA-GF	F/CST 225-709 IMP 225-36-2	96 67	C/HLD 225-1 IT 225-22	102 67	
Nicotine	NIOSH 2544		0.5 mg/m³	360		1000		6		GC-NPD	ST 226-30-04	38			
Nicotine	NIOSH 2551		0.5 mg/m³	480		1000		8		GC-NPD	ST 226-93	40			
Nicotine	NON 19			120		1000		2		GC	ST 226-93	40			
Nicotine	NON 49			90-720		1500		1- 8		GC-NSD	ST 226-170	41			
Nicotine & 3-ethenylpyridine	ASTM D 5075	1427		varies		1500		varies		GC-NPD	ST 226-93	40			
Nigrospora species (fungi, molds, spores)	OSHA CSI			120		1000		2		varies	F/CST 225-3-01	90	C/HLD 225-1	102	
Nigrospora species (fungi, molds, spores)	OSHA CSI			141.5		28300		5 min		varies	BI 225-9611	120			
Niobium (Elements by ICP HNO ₃ Digestion))	NIOSH 7303		0.012 mg/m³	0.1-3300		1000-4000		varies		ICP-AES	F/CST 225-3-01	90	C/HLD 225-1	102	
Nitric acid	NIOSH 7907		2	4	600	30	2000	2000	5	15	IC-CD	CF/CST 225-9032	64	C/HLD 225-1	102
Nitric acid	OSHA ID 165SG		2		96	7.5	200	500	8	15	IC	ST 226-10-03	38		
Nitric oxide	OSHA ID 190		25		6		25		4		IC	ST 226-40	39		
Nitric oxide & nitrogen dioxide	NIOSH 6014	1390	25 (NO)	1 (NO ₂)	1.5-6		25		1-4		VAS	ST 226-40	39		
5-Nitro-2-furaldehyde semicarbazone	OSHA CSI			240		1000		24 min		HPLC-UV	F/CST 225-709	96	C/HLD 225-1	102	
p-Nitroaniline	NIOSH 5033		3 mg/m³	240		1000		4		HPLC-UV	F/CST 225-3-01	90	C/HLD 225-1	102	
p-Nitroaniline	OSHA CSI		1 mg/m³	90		1500		1		HPLC-UV	F/CST 225-3-01	90	C/HLD 225-1	102	
Nitrobenzene	EPA TO-17	1689		1 L & 4 L		16.7 ml/min & 66.7 ml/min				TD, GC	ST 226-300 Series CPC 224-26-CPC	42 51	TH 224-26-02	51	
Nitrobenzene	NIOSH 2005		1		48		100		8		GC-FID	ST 226-10	38		
Nitrobenzene	NIOSH 2017		1		24		200		2		GC-FID	CF/CST 225-9004	64	ST 226-15	38
4-Nitrophenyl	OSHA CSI			240		500		8		GC-FID	ST 226-30-16	38			
p-Nitrochlorobenzene	OSHA CSI		1 mg/m³	150		1000		2.5		GC-FID	ST 226-10	38			
p-Nitrochlorobenzene (nitrobenzenes)	NIOSH 2005		0.1		96		200		8		GC-FID	ST 226-10	38		
Nitrochloroform	NON 51		0.1		144		100		24		GC-MSD	ST 226-175	41		
Nitrochloromethane	NON 51		0.1		144		100		24		GC-MSD	ST 226-175	41		
4-Nitrodiphenyl	OSHA PV2082			240		500		8		GC-FID	ST 226-30-16	38			
Nitroethane	NIOSH 2526		100		2.4		20		2		GC-FID	ST 226-3002A	42		
Nitrofurazone	OSHA PV2069			240		1000		4		HPLC-UV	F/CST 225-709	96	C/HLD 225-1	102	
Nitrogen dioxide	NIOSH 6014			1 (NO ₂)	1.5-6		25-200		varies		VAS	ST 226-40-02	39		
Nitrogen dioxide	OSHA ID 182	1406		5 (C)		3		200		15	IC	ST 226-40	or	ST 226-40-02	39
Nitrogen dioxide & nitric oxide	NIOSH 6014	1390	25 (NO)	1 (NO ₂)	1.5-6		25		1-4		VAS	ST 226-40	39		
Nitrogen dioxide & nitric oxide	NON 11				0.75		50		15		CLR	ST 226-40	39		
Nitrogen dioxide & nitric oxide	OSHA ID 182	1389	25 (NO)	5 (NO ₂)	6	3	25	200	4	15	IC	ST 226-40	39		
Nitroglycerin	NIOSH 2507			0.1 mg/m³	3		200		15		GC-ECD	ST 226-35-03	39		
Nitroglycerin	OSHA 43			0.1 mg/m³	15		1000		15		HPLC	ST 226-35-03	39		
Nitromethane	NIOSH 2527			2.4		20		2			GC-NSD	ST 226-111A	40		

Agency standards for OSHA listings represent the OSHA PELs reported in the 29 CFR 1910.1000 Part 1910, Section 1000.

References and abbreviations are found on pages 212-213.

Chemical Hazard	Agency Reference	Chem F File	SAMPLING ∞								Analytical Method	SKC Collecting Equipment & Page Number						
			Agency Standard		Vol. (liter)		Rate (ml/min)		Time									
			TWA (ppm)	CLG/STEL (ppm)	TWA (Sample Time or Air Volume)	CLG/STEL	TWA (Flow/Sampling Rate)	CLG/STEL	TWA (hrs)	CLG/STEL (min)								
Nitromethane	OSHA CSI		100		3		50			1		GC-NPD	ST	226-111A	40			
p-Nitrophenol	OSHA CSI				100		1000			100 min		HPLC-UV	IMP	225-36-1	67	IT	225-22	67
1-Nitropropane	OSHA 46		25		3		100			30 min		GC-FID	ST	226-93	40			
2-Nitropropane	NIOSH 2528		LFC		2		20			1.5		GC-FID	ST	226-110	40			
2-Nitropropane	OSHA 46		25		3		100			30 min		GC-FID	ST	226-93	40			
1-Nitropyrene	OSHA CSI				960		2000			8		HPLC-UV	F/CST	225-706	96	C/HLD	225-1	102
1-Nitropyrene in diesel particulates	NIOSH 2560				480-960		1000-2000			varies		GC-NCD	FLT SPC	225-7 225-23	96 103	SP	225-27	103
N-Nitrosodiethanolamine	OSHA 31				480		2000			4		GC-TEA	F/CST	225-706	96	C/HLD	225-1	102
N-Nitrosodiphenylamine	OSHA 23				240		1000			4		HPLC-UV	IMP	225-36-2	67	IT	225-22	67
Nitrotoluene (m-isomer)	OSHA CSI		5		30		200			2.5		GC-FID	ST	226-10	38			
m-Nitrotoluene (nitroaromatic compounds)	NIOSH 2005		2 ppm		96		200			8		GC-FID	ST	226-10	38			
o-Nitrotoluene (nitroaromatic compounds)	NIOSH 2005		2 ppm		96		200			8		GC-FID	ST	226-10	38			
p-Nitrotoluene (nitroaromatic compounds)	NIOSH 2005		2 ppm		96		200			8		GC-FID	ST	226-10	38			
Nitrotoluene (nitrobenzenes)	NIOSH 2005		2 ppm		96		200			8		GC-FID	ST	226-10	38			
Nitrous oxide	NIOSH 6600	1028	25		3		100-4000			varies		P IR	SB	231-05	54			
trans-Nonachlor	ASTM D 4861				240-7200		1000-5000			4-24		GC-ECD	PUF	226-92	44			
Nonane	EPA TO-17	1689			1 L & 4 L		16.7 ml/min & 66.7 ml/min					TD, GC	ST CPC	226-300 Series 224-26-CPC	42 51	TH	224-26-02	51
Nonane	OSHA CSI				3		50			1		GC-FID	ST	226-01	38			
n-Nonane (hydrocarbons, BP 36 to 216 C)	NIOSH 1500		200		4		10-200			varies		GC-FID	ST	226-01	38			
Nonpolar organic compounds	NON 38		varies		varies		varies			varies		GC	PUF	226-129	45			
Non-sporulating fungi	OSHA CSI				120		1000			2		varies	F/CST	225-3-01	90	C/HLD	225-1	102
Non-sporulating fungi	OSHA CSI				141.5		28300			5 min		varies	BI	225-9611	120			
Nonyl alcohol	OSHA CSI				10		20(50)			8(3.3)		GC-FID	ST	226-01	38			
Nonylphenol	OSHA CSI				24		100			4		HPLC-UV	ST	226-95	40			
Norethindrone	OSHA PV2070				480		2000			4		HPLC-UV	F/CST	225-802	93	C/HLD	225-1	102
Nuisance dust (particulates, respirable)	NIOSH 0600	1038			375		2500			2.5		GR	FLT CYC	225-5-37-P 225-01-02	93 111	C/HLD CST	225-1 225-3LF	102 97
Nuisance dust (particulates, total)	NIOSH 0500	1035			120		2000			1		GR	FLT CST	225-5-37-P 225-2LF	93 97	C/HLD	225-1	102
Nuisance dust (see dust, respirable nuisance)																		
Octachloronaphthalene	OSHA CSI		0.1 mg/m ³		30	15	1000	1000		0.5	15	GC-ECD	F/CST	225-3-01	90	C/HLD	225-1	102
Octadecanol	OSHA CSI				10		100			100 min		GC-FID	ST	226-01	38			
Octane	OSHA 07	1141	500		5	3	20	200		4	15	GC-FID	ST	226-01	38			
n-Octane	EPA TO-17	1689			1 L & 4 L		16.7 ml/min & 66.7 ml/min					TD, GC	ST CPC	226-300 Series 224-26-CPC	42 51	TH	224-26-02	51
n-Octane	OSHA PV2138		500		4		50			80 min		GC-FID	ST	226-01	38			
n-Octane (hydrocarbons, BP 36 to 216 C)	NIOSH 1500		75	385	4	4	0-200	0-200		varies	varies	GC-FID	ST	226-01	38			
1-Octanethiol	NIOSH 2510			0.5 (15 min)			3			200		15	GC-FPDS	ST	226-35-03	39		
Octanol	EPA TO-17	1689			1 L & 4 L		16.7 ml/min & 66.7 ml/min					TD, GC	ST CPC	226-300 Series 224-26-CPC	42 51	TH	224-26-02	51
Octyl alcohol	EPA TO-17	1689			1 L & 4 L		16.7 ml/min & 66.7 ml/min					TD, GC	ST CPC	226-300 Series 224-26-CPC	42 51	TH	224-26-02	51
di-n-Octyl phthalate (DNOP)	OSHA 104				240		1000			4		GC-FID	ST	226-56	39			
Oil mist (mineral)	NIOSH 5026	1526	5 mg/m ³	10 mg/m ³	480	30	1000	2000		8	15	IR	F/CST C/HLD	225-3-01 225-1	or 102	F/CST	225-802	93
Oil mist (mineral)	OSHA ID 128		5 mg/m ³		960		2000			8		FLUOR	FLT CST	225-5-37-P 225-2LF	93 97	C/HLD	225-1	102
Oil mist (mineral)	OSHA ID 178SG		5 mg/m ³		960		2000			8		GR & IR	FLT CST	225-5-37-P 225-2LF	93 97	C/HLD	225-1	102
Oil mist (total aerosol)	NON 46		5 mg/m ³		varies		2000			varies		GR	IOM	225-70A	108	FLT	225-5-25	93
Oil mist (vegetable) (see dust, total & respirable nuisance)																		
Organic vapors (charcoal tube method)	ASTM D 3686				varies	varies	varies	varies		varies	varies	GC	ST	226-01	38			
Organic vapors (diffusive sampler method)	ASTM D 4597				varies	varies	varies	varies		varies	varies	GC	PS	575-001	or	PS	575-002	75
Organonitrogen pesticides (see specific compounds)	NIOSH 5601				240		1000			4		HPLC-UV	ST	226-58	or	ST	226-30-16	38
Organophosphorus pesticides (see specific compounds)	NIOSH 5600		varies		varies		varies			8		GC-FPD	ST	226-58	39			
Organotin compounds as Sn (see specific compounds)	NIOSH 5504		0.1 mg/m ³		480		1000			8		HPLC & AA-GF	ST C/HLD	226-30 225-1	38 102	F/CST	225-709	96
Organotin compounds as Sn (see specific compounds)	NIOSH 5526		0.1 mg/m ³		60	60	250	1000		4	60	GC-FPD	ST	226-30-16	38			
Orthene (acephate)	OSHA CSI				240		1000			4		HPLC-UV	F/CST	225-706	96	C/HLD	225-1	102
Oryzalin	OSHA CSI				120		1000			2		HPLC-UV	F/CST IMP	225-706 225-36-1	96 67	C/HLD IT	225-1 225-22	102 67

Agency standards for OSHA listings represent the OSHA PELs reported in the 29 CFR 1910.1000 Part 1910, Section 1000.

References and abbreviations are found on pages 212-213.

Sampling Guide

www.skinc.com for updates

O

Chemical Hazard	Agency Reference	Chem F File	SAMPLING ∞										Analytical Method	SKC Collecting Equipment & Page Number					
			Agency Standard		Vol. (liter)		Rate (ml/min)		Time										
			TWA (ppm)	CLG/STEL (ppm)	TWA (Sample Time or Air Volume)	CLG/STEL	TWA (Flow/Sampling Rate)	CLG/STEL	TWA (hrs)	CLG/STEL (min)									
Oxalic acid	OSHA PV2115		1 mg/m ³		100			1000			100 min		IC	FLT C/HLD	225-701	90	CST	225-3LF	97
Oxamyl (Organonitrogen Pesticides)	NIOSH 5601				240			1000			4		HPLC-UV	ST	226-58	or	ST	226-30-16	38
Oxamyl (Vydate)	OSHA CSI				60			1000			1		HPLC	ST	226-30-16			38	
Oxychlorane	ASTM D 4861				240-7200			1000-5000			4-24		GC-ECD	PUF	226-92			44	
Oxydemeton methyl	OSHA CSI				480			1000			8		GC-FPD	ST	226-30-16			38	
Ozone	OSHA ID 214		0.1		90			500			3		IC	CF/CST C/HLD	225-9014	64	ST	Special order Σ	102
Paecilomyces species (fungi, molds, spores)	OSHA CSI				120			1000			2		varies	F/CST	225-3-01	90	C/HLD	225-1	102
Paecilomyces species (fungi, molds, spores)	OSHA CSI				141.5			28300			5 min		varies	BI	225-9611	120			
PAHs (Polynuclear Aromatic Hydrocarbons by GC, see specific compounds)	NIOSH 5515	1464			480			2000			4		GC-FID	F/CST C/HLD	225-1713	94	ST	226-30-04	38
PAHs (Polynuclear Aromatic Hydrocarbons by GC-MS, see specific compounds)	ASTM D 6209				350 m ³ (max)			225 L/min			1-24		GC-MS	PUF	226-131	45	FLT	225-1808	95
PAHs (Polynuclear Aromatic Hydrocarbons by HPLC, see specific compounds)	NIOSH 5506	1464			480			2000			4		HPLC-UV	F/CST C/HLD	225-1713	94	ST	226-30-04	38
Palladium (Elements by ICP HNO ₃ Digestion)	NIOSH 7303				0.1-3.300			1000-4000			varies		ICP-AES	F/CST	225-3-01	90	C/HLD	225-1	102
Palladium (see dust, total nuisance)	OSHA CSI																		
Pancreatin	OSHA CSI				480			2000			4		IRA	F/CST	225-1713	94	C/HLD	225-1	102
Papain	OSHA CSI				60,000			1000 L/min			1		GC-FID	FLT	225-7-07	96			
Paper fiber (cellulose) (particulates, respirable)	NIOSH 0600	1038			375			2500			2.5		GR	FLT CYC	225-5-37-P	93	C/HLD	225-1	102
Paper fiber (cellulose) (particulates, total)	NIOSH 0500	1035			120			2000			1		GR	FLT CST	225-5-37-P	93	C/HLD	225-1	102
PAPI	OSHA CSI				15			1000			15 min		HPLC-UV	FLT C/HLD	225-7 ‡	96	CST	225-3LF	97
Paraffin wax fume	OSHA PV2047				100			1000			100 min		GC-FID	F/CST	225-706	96	C/HLD	225-1	102
Paraquat	NIOSH 5003		0.1 mg/m ³		480			1000			8		HPLC-UV	FLT C/HLD	225-17-01	94	CST	225-2LF	97
Paraquat (respirable dust)	OSHA CSI		0.5 mg/m ³		960			4000			4		HPLC-UV	FLT C/HLD	225-17-01	94	CST	225-2LF	97
Parathion	OSHA 62	1398	0.1 mg/m ³		480			1000			8		GC-FPD	ST	226-30-16	38			
Parathion (Organophosphorus Pesticides)	NIOSH 5600		0.05 mg/m ³		240			1000			4		GC-FPD	ST	226-58	39			
Particulates not otherwise regulated (total dust)	OSHA CSI		15 mg/m ³		720			1500			8		GR	FLT CST	225-5-37-P	93	C/HLD	225-1	102
Particulates not otherwise regulated, respirable	NIOSH 0600	1038			375			2500			2.5		GR	FLT CYC	225-5-37-P	93	C/HLD	225-1	102
Particulates not otherwise regulated, respirable fraction	OSHA CSI		5 mg/m ³		varies			varies			varies		GR	FLT CYC	225-5-37-P	93	C/HLD	225-1	102
Particulates, inorganic (bioaerosols)					15-150			15000			1-10 min		varies	STC	225-9820	101			
Particulates, respirable	NIOSH 0600	1038			375			2500			2.5		GR	FLT CYC	225-5-37-P	93	C/HLD	225-1	102
Particulates, total (see specific compounds)	NIOSH 0500	1035			120			2000			1		GR	FLT CST	225-5-37-P	93	C/HLD	225-1	102
Particulates, total (see specific compounds)	NIOSH 0501				120			2000			1		GR	AC CST	225-8516GLA	93	C/HLD	225-1	102
PCBs (42% Cl) (see polychlorobiphenyls)	NIOSH 5503																		
PCBs (54% Cl) (see polychlorobiphenyls)	NIOSH 5503																		
PCBs (polychlorinated biphenyls)	EPA TO-4A	1670						200-280 L/min			24 hrs		varies	PUF	226-131	41	FLT	225-1808	95
Penicillium species (fungi, molds, spores)	OSHA CSI				120			1000			2		varies	F/CST	225-3-01	90	C/HLD	225-1	102
Penicillium species (fungi, molds, spores)	OSHA CSI				141.5			28300			5 min		varies	BI	225-9611	120			
Pentaborane	OSHA CSI		0.005		480	15		1000	1000		8	15	ICP	IT	225-22	67	IMP	225-36-2	67
Pentac (bis [pentachloro-2,4-cyclopentadien-1-yl])	OSHA CSI				120			1000			2		HPLC-UV	FLT IMP C/HLD	225-9	88	CST	225-3LF	97
Pentachlorobenzene	ASTM D 4861				240-7200			1000-5000			4-24		GC-ECD	PUF	226-92	44			
Pentachlorobenzene (polychlorobenzenes)	NIOSH 5517				12			25			8		GC-ECD	FLT ST	225-17-03	94	CST	Special order	
Pentachloroethane	NIOSH 2517				10			20			8		GC-ECD	ST	226-59-04	39			
Pentachloroethane	OSHA CSI				10			20			8		GC-ECD	ST	226-59-04	39			
Pentachloronaphthalene	OSHA CSI		0.5 mg/m ³		90			1000			1.5		GC-ECD	ST	226-30-16	38			
Pentachlorophenol	ASTM D 4861				240-7200			1000-5000			4-24		GC-ECD	PUF	226-92	44			
Pentachlorophenol	NIOSH 5512		0.5 mg/m ³		480			1000			8		HPLC-UV	CST IMP	225-3LF	97	SCN	225-26	103
Pentachlorophenol	OSHA 39		0.5 mg/m ³		48			200			4		HPLC-UV	FLT	225-36-2	67	IT	225-22	67
Pentachlorophenol	OSHA 39		0.5 mg/m ³		48			200			4		HPLC-UV	ST	226-97	40			

Agency standards for OSHA listings represent the OSHA PELs reported in the 29 CFR 1910.1000 Part 1910, Section 1000.

References and abbreviations are found on pages 212-213.

Chemical Hazard	Agency Reference	Chem F File	SAMPLING ∞								Analytical Method	SKC Collecting Equipment & Page Number					
			Agency Standard		Vol. (liter)		Rate (ml/min)		Time								
			TWA (ppm)	CLG/STEL (ppm)	TWA (Sample Time or Air Volume)	CLG/STEL	TWA (Flow/Sampling Rate)	CLG/STEL	TWA (hrs)	CLG/STEL (min)							
Pentaerythritol (particulates, respirable)	NIOSH 0600	1038			375		2500		2.5		GR	FLT CYC	225-5-37-P 225-01-02	93 111	C/HLD CST	225-1 225-3LF	102 97
Pentaerythritol (particulates, total)	NIOSH 0500	1035			120		2000		1		GR	FLT CST	225-5-37-P 225-2LF	93 97	C/HLD	225-1	102
Pentaerythritol (respirable dust)	OSHA CSI		5 mg/m ³		varies		varies		varies		GR	FLT CYC	225-5-37-P 225-105	93 110	C/HLD CST	225-1 225-3LF	102 97
Pentaerythritol (total dust)	OSHA CSI		15 mg/m ³		960		2000		8		GR	F/CST	225-803	93	C/HLD	225-1	102
Pentamethyldiethylenetriamine	OSHA CSI				480		1000		8		GC-NPD	IMP	225-36-1	67	IT	225-22	67
Pentamidine isethionate	NIOSH 5032				960		2000		8		HPLC-FD	CST C/HLD	225-4 225-1	97 102	FLT	225-5-37-P	93
Pentane	OSHA 07	1140	1000		2	0.75	20	50	1.6	15	GC-FID	ST	226-01	38			
n-Pentane	EPA TO-17	1689			1 L & 4 L		16.7 ml/min & 66.7 ml/min				TD, GC	ST CPC	226-300 Series 224-26-CPC	42 51	TH	224-26-02	51
n-Pentane (hydrocarbons, BP 36 to 216 C)	NIOSH 1500		120	610	4	4	10-200	10-200	varies	varies	GC-FID	ST	226-01	38			
2,3-Pentanedione	OSHA 1016				10	3	50	200 (min)	200	15	GC-FID	ST	226-183	41			
2-Pentanone (Ketones I)	NIOSH 2555				1-10		10-200		varies		GC-FID	ST	NA SKC				
2-Pentanone (methyl propyl ketone)	OSHA 07	1139	200		10	3	20(50)	200	8(3.3)	15	GC-FID	ST	226-01	38			
2-Pentanone (methyl propyl ketone) (Ketones I)	NIOSH 1300		150		10		20(50)		8(3.3)		GC-FID	ST	226-01	38			
1-Pentene	OSHA CSI				10		20(50)		8(3.3)		GC-FID	ST	226-01	38			
Peracetic acid	NON 57					15		1000 *		15	MAS/HPLC-UV	CF/CST ST	225-9030 226-199	64 39	ST	226-193	or
Perchloric acid	OSHA ID 115SG				120		500		4		CLR	IMP	225-36-2	67	IT	225-22	67
Perchloroethylene	EPA TO-17	1689			1 L & 4 L		16.7 ml/min & 66.7 ml/min				TD, GC	ST CPC	226-300 Series 224-26-CPC	42 51	TH	224-26-02	51
Perchloroethylene	Indoor	1689					13.1 ml/min		8-24 hrs		TD, GC	PS PS	690-101 690-104	or 84	PS	690-103	or
Perchloroethylene (tetrachloroethylene)	OSHA 1001		100	200 (C)	12	0.75	50	50	4	5	GC-FID	ST	226-01	38			
Perchloroethylene (tetrachloroethylene)	OSHA 1001		100	200 (C)			13.06		8	5	GC-FID	PS	575-002	75			
Perchloroethylene (tetrachloroethylene) (hydrocarbons, halogenated)	NIOSH 1003		LFC		3		10-200		varies		GC-FID	ST	226-01	38			
Perchloroethylene (tetrachloroethylene) (portable GC)	NIOSH 3704		LFC		1		20-5000		varies		P GC	SB	232-01	55			
Perchloryl fluoride	OSHA CSI		3		240	15	1000	1000	4	15	ISE	IMP	225-36-2	67	IT	225-22	67
Perlite (< 1% Quartz) (see dust, total & respirable nuisance)																	
cis-Permethrin	ASTM D 4861				240-7200		1000-5000		4-24		HPLC-UV	PUF	226-92	44			
trans-Permethrin	ASTM D 4861				240-7200		1000-5000		4-24		HPLC-UV	PUF	226-92	44			
Peroxyacetic acid (peracetic acid) & Hydrogen peroxide	NON 57					15		1000 *		15	MAS/HPLC-UV	CF/CST ST	225-9030 226-199	64 39	ST	226-193	or
Pesticides	EPA IP-8	1675					1-5 L/min		4-24 hrs		GC-ECD	PUF	226-92	or	PUF	226-124	41
Pesticides	EPA TO-10A	1675					1-5 L/min		4-24 hrs		GC-ECD	PUF	226-92	or	PUF	226-124	41
Pesticides, carbamate	ASTM D 4861				240-7200		1000-5000		4-24		HPLC-UV	PUF	226-92	44			
Pesticides, organochlorine	ASTM D 4861	1253			240-7200		1000-5000		4-24		varies	PUF	226-92	or	PUF	226-124	44
Pesticides, organochlorine	EPA TO-4A	1670					200-280 L/min		24 hrs		varies	PUF	226-131	41	FLT	225-1808	95
Pesticides, organonitrogen (see specific compounds)	NIOSH 5601				240		1000		4		HPLC-UV	ST	226-58	or	ST	226-30-16	38
Pesticides, organophosphorus	ASTM D 4861	1253			240-7200		1000-5000		4-24		varies	PUF	226-92	or	PUF	226-124	44
Pesticides, pyrethrin	ASTM D 4861				240-7200		1000-5000		4-24		HPLC-UV	PUF	226-92	44			
Pesticides, triazine	ASTM D 4861				240-7200		1000-5000		4-24		HPLC-UV or GC-ECD	PUF	226-92	44			
Petroleum distillate (naphthas)	NIOSH 1550		350 mg/m ³	1800 mg/m ³	3.6	1.5	20	100	3	15	GC-FID	ST	226-01	38			
Petroleum distillate fractions (PDF)	OSHA 48		500		3		20		2.5		GC-FID	ST	226-01	38			
Petroleum ether (benzin) (naphthas)	NIOSH 1550		350 mg/m ³	1800 mg/m ³	3	1.5	20(50)	100	2.5(1)	15	GC-FID	ST	226-01	38			
Petroleum naphtha (naphthas)	NIOSH 1550		350 mg/m ³	1800 mg/m ³	3	1.5	20(50)	100	2.5(1)	15	GC-FID	ST	226-01	38			
Peziza species (fungi, molds, spores)	OSHA CSI				120		1000		2		varies	F/CST	225-3-01	90	C/HLD	225-1	102
Peziza species (fungi, molds, spores)	OSHA CSI				141.5		28300		5 min		varies	BI	225-9611	120			
Phenanthrene	OSHA 58				960		2000		8		GR & HPLC-FD, or GR & HPLC-UV	FLT C/HLD	225-7 225-1	96 102	CST	225-2LF	97
Phenanthrene (Polynuclear Aromatic Hydrocarbons by GC-MS)	ASTM D 6209				350 m ³ (max)		225 L/min		1-24		GC-MS	PUF	226-131	45	FLT	225-1808	95
Phenanthrene (Polynuclear Aromatic Hydrocarbons by GC)	NIOSH 5515				480		2000		4		GC-FID	F/CST C/HLD	225-1713 225-1	94 102	ST	226-30-04	38
Phenanthrene (Polynuclear Aromatic Hydrocarbons by HPLC)	NIOSH 5506				480		2000		4		HPLC-UV	F/CST C/HLD	225-1713 225-1	94 102	ST	226-30-04	38
Phenol	EPA TO-17	1689			1 L & 4 L		16.7 ml/min & 66.7 ml/min				TD, GC	ST CPC	226-300 Series 224-26-CPC	42 51	TH	224-26-02	51

Agency standards for OSHA listings represent the OSHA PELs reported in the 29 CFR 1910.1000 Part 1910, Section 1000.

References and abbreviations are found on pages 212-213.

Sampling Guide

www.skinc.com for updates

P	Chemical Hazard	Agency Reference	Chem F File	SAMPLING ∞								Analytical Method	SKC Collecting Equipment & Page Number			
				Agency Standard		Vol. (liter)		Rate (ml/min)		Time						
				TWA (ppm)	CLG/STEL (ppm)	TWA (Sample Time or Air Volume)	CLG/STEL	TWA (Flow/Sampling Rate)	CLG/STEL	TWA (hrs)	CLG/STEL (min)					
Phenol	EPA TO-8	1668			< 80 L		100-1000 ml/min			HPLC-UV	IMP	225-36-1	67	IT	225-22	67
Phenol	OSHA 32	1019	5		24		100		4	HPLC-UV	ST	226-95		40		
Phenol (cresols)	NIOSH 2546		5	15.6 (15 min)	24	3	100	200	4	15	GC-FID	ST	226-95		40	
Phenolics (screening)	NIOSH 2549				5		20		4		GC-MS	ST	226-330		42	
Phenothiazine	OSHA PV2048				100		1000		1		GC-NPD	F/CST	225-706	96	C/HLD	225-1 102
2-Phenoxyethanol	OSHA CSI				10		200		50 min		GC-FID	ST	226-01		38	
2-Phenoxyethyl acrylate	OSHA CSI				24		100		4		GC-FID	ST	226-22		38	
1-Pheny-1-cyclohexene	OSHA CSI				10		200		50 min		GC-FID	ST	226-01		38	
Phenyl ether	NIOSH 1617		1		48		100		8		GC-FID	ST	226-01		38	
Phenyl ether	OSHA 07	1138	1		10		20(50)		8(3,3)		GC-FID	ST	226-01		38	
Phenyl ether	OSHA PV2022		1		20		200		100 min		GC-FID	ST	226-95		40	
Phenyl ether-biphenyl mix	NIOSH 2013		1		24		50		8		GC-FID	ST	226-10		38	
Phenyl ether-biphenyl mix	OSHA CSI		1		10		20(50)		8(3,3)		GC-FID	ST	226-95		40	
Phenyl glycidyl ether	NIOSH 1619			1 (15 min)		80		1000		80	GC-FID	ST	226-01		38	
Phenyl glycidyl ether	OSHA 07	1137	10		48		100		8		GC-FID	ST	226-01		38	
Phenyl hydrazine	NIOSH 3518			0.14 (120 min)		120		1000		120	VAS	IMP	225-36-2	67	IT	225-22 67
Phenyl hydrazine	OSHA CSI		5		100	15	1000	1000	100 min	15	CLR	IMP	225-36-2	67	IT	225-22 67
Phenyl mercaptan	OSHA PV2075				20		200		100 min		GC-FID	CF/CST	225-9007	64	C/HLD	225-1 102
N-Phenyl-1-naphthylamine	OSHA 96				240		2000		4		HPLC-FD	FLT C/HLD	225-703 ‡ 225-1	96	CST	225-309 97
N-Phenyl-2-naphthylamine	OSHA 96				240		1000		4		HPLC-FD	FLT C/HLD	225-703 ‡ 225-1	96	CST	225-309 97
N-Phenyl-2-naphthylamine	OSHA CSI										W	W	225-2401A		140	
4-Phenylcyclohexene	OSHA CSI				10		200		50 min		GC-FID	ST	226-01		38	
m-Phenylenediamine	OSHA 87	1231			100		1000		100 min		HPLC-UV	CF/CST	225-9004	64	C/HLD	225-1 102
o-Phenylenediamine	OSHA 87	1231			100		1000		100 min		HPLC-UV	CF/CST	225-9004	64	C/HLD	225-1 102
p-Phenylenediamine	OSHA 87	1231	0.1 mg/m³		100		1000		100 min		HPLC-UV	CF/CST	225-9004	64	C/HLD	225-1 102
Phenylloxirane (see styrene oxide)	OSHA CSI				10		20(50)		8(3,3)		GC-FID	ST	226-35		38	
o-Phenylphenol	ASTM D 4861				240-7200		1000-5000		4-24		HPLC-UV	PUF	226-92		44	
o-Phenylphenol	OSHA CSI				10		20(50)		8(3,3)		GC-FID	ST	226-35		38	
Phoma species (fungi, molds, spores)	OSHA CSI				120		1000		2		varies	F/CST	225-3-01	90	C/HLD	225-1 102
Phoma species (fungi, molds, spores)	OSHA CSI				141.5		28300		5 min		varies	BI	225-9611		120	
Phorate	ASTM D 4861				240-7200		1000-5000		4-24		GC-NPD	PUF	226-92		44	
Phorate (Organophosphorus Pesticides)	NIOSH 5600		0.05 mg/m³	0.2 mg/m³	240		1000		4		GC-FPD	ST	226-58		39	
Phorate (Thimet)	OSHA CSI				480	15	1000	1000	8	15	GC-FPD	ST	226-30-16		38	
Phosdrin (mevinphos)	OSHA CSI		0.1 mg/m³		480	15	1000	1000	8	15	GC-FPD	ST	226-30-16		38	
Phosdrin (mevinphos) (Organophosphorus Pesticides)	NIOSH 5600		0.01	0.03	120	15	1000	1000	2	15	GC-FPD	ST	226-58		39	
Phosgene	EPA TO-6	1669			< 50 L		100-1000 ml/min				HPLC-UV	IMP	225-36-1	67	IT	225-22 67
Phosgene	OSHA 61		0.1		240		1000		4		GC-NPD	ST	226-117		40	
Phosgene & chloroformates	NON 40				24		50		8		GC-FPD	ST	226-153		41	
Phosmet (Imidan)	OSHA CSI				120		1000		2		HPLC-UV	F/CST	225-706	96	C/HLD	225-1 102
Phosphine	NIOSH 6002		0.3	1	12	3	100	200	8	15	UV-VIS	ST	226-165A ††		41	
Phosphine	OSHA 1003	1698	0.3		240	30	1000	2000	4	15	ICP-AES	CF/CST	225-9018 ††	64	C/HLD	225-1 102
Phosphoric acid	NIOSH 7908		1 mg/m³	3 mg/m³	960	30	2000	2000	8	15	IC-cd	CF/CST	225-9033	64	C/HLD	225-1 102
Phosphoric acid	OSHA ID 111	1466	1 mg/m³		960	30	2000	2000	8	15	IC	F/CST	225-3-01	90	C/HLD	225-1 102
Phosphoric acid	OSHA ID 16SSG		1 mg/m³		960	30	2000	2000	8	15	IC	ST	226-10-03		38	
Phosphorous (Elements by ICP HNO ₃ Digestion)	NIOSH 7303		0.1 mg/m³		250-500,000		1000-4000		varies		ICP-AES	F/CST	225-3-01	90	C/HLD	225-1 102
Phosphorus	NIOSH 7905		0.1 mg/m³		12		200		1		GC-FPD	ST	226-35-03		39	
Phosphorus (Elements by Cellulosic Internal Capsule Sampler)	NIOSH 7306		0.1 mg/m³		9-2000		1000-4000		Varies		ICP-AES	SC	225-8517	90	C/HLD	225-1 102
Phosphorus (Elements by ICP Aqua Regia Ashing)	NIOSH 7301		0.1 mg/m³		25-2000		1000-4000		varies		ICP-AES	F/CST C/HLD	225-3-01 225-1	or 102	F/CST	225-803 ¥ 93
Phosphorus (Elements by ICP HNO ₃ /HClO ₄ Ashing)	NIOSH 7300	1455	0.1 mg/m³		25-200		1000-4000		varies		ICP-AES	F/CST	225-3-01	90	C/HLD	225-1 102
Phosphorus (Elements on Wipes)	NIOSH 9102				wipe						ICP-AES	W TMP	225-2414 225-2415	140 140	TMP	225-2403 or
Phosphorus (yellow)	OSHA CSI		0.1 mg/m³		96		200		8		GC-FPD	ST	226-35-03		39	
Phosphorus oxychloride	OSHA CSI				240		1000		4		IC	IMP	225-36-2	67	IT	225-22 67

Agency standards for OSHA listings represent the OSHA PELs reported in the 29 CFR 1910.1000 Part 1910, Section 1000.

References and abbreviations are found on pages 212-213.

Chemical Hazard	Agency Reference	Chem F File	SAMPLING ∞						Analytical Method	SKC Collecting Equipment & Page Number							
			Agency Standard		Vol. (liter)		Rate (ml/min)									Time	
			TWA (ppm)	CLG/STEL (ppm)	TWA	CLG/STEL	TWA	CLG/STEL								TWA (hrs)	CLG/STEL (min)
Phosphorus pentachloride	OSHA CSI		1 mg/m ³		48		200		4		CLR	F/CST IT	225-803 225-22	93 67	IMP SCN	225-36-2 225-26	67 103
Phosphorus pentasulfide	OSHA ID 128SG		1 mg/m ³		960	30	2000	2000	8	15	IC	F/CST	225-802	93	C/HLD	225-1	102
Phosphorus pentoxide	OSHA ID 111				480		1000		8		IC	F/CST	225-3-01	90	C/HLD	225-1	102
Phosphorus trichloride	NIOSH 6402		0.2	0.5	24		200		2		VAS	IMP	225-36-2	67	IT	225-22	67
Phosphorus trichloride	OSHA CSI		0.5		96	3	200	200	8	15	CLR	IMP	225-36-2	67	IT	225-22	67
Phosvel	OSHA CSI				480		1000		8		GC-FPD	ST	226-30-16	38			
Phthalates (see specific compounds)																	
Phthalic acid	OSHA CSI				10		200		50 min		HPLC	ST	226-01	38			
Phthalic anhydride	OSHA 90		2		75		1000		1.25		HPLC-UV	FLT C/HLD	225-7 ‡ 225-1	96 102	CST	225-3LF	97
m-Phthalodinitrile	OSHA CSI				20		200		100 min		GC-NPD	ST	226-01	38			
Picloram (tordon) (total dust)	OSHA PV2049		15 mg/m ³		60		1000		1		GR	F/CST	225-803	93	C/HLD	225-1	102
Picloram (tordon) (respirable dust)	OSHA CSI		5 mg/m ³		varies		varies		varies		GR	FLT CYC	225-5-37-P 225-105	93 110	C/HLD CST	225-1 225-3LF	102 97
Picric acid	OSHA CSI		0.1 mg/m ³		180		1500		2		HPLC-UV	F/CST	225-3-01	90	C/HLD	225-1	102
Pindone	OSHA CSI		0.1 mg/m ³		180		1000		3		HPLC-UV	FLT ST	225-17-01 226-35-03	94 39	CST C/HLD	225-2LF 225-1	97 102
alpha-Pinene	OSHA CSI				10		20(50)		8(3.3)		GC-FID	ST	226-01	38			
beta-Pinene	OSHA CSI				10		20(50)		8(3.3)		GC-FID	ST	226-01	38			
alpha-Pinene (terpenes)	NIOSH 1552				24		50		8		GC-FID	ST	226-01	38			
beta-Pinene (terpenes)	NIOSH 1552				24		50		8		GC-FID	ST	226-01	38			
Piperazine dihydrochloride	OSHA CSI				96		200		8		GC-NPD	F/CST	225-709	96	C/HLD	225-1	102
Piperidine	OSHA CSI				6		200		30 min		GC-FID	ST	226-01	38			
Piperonyl butoxide	OSHA PV2110				30		1000		30 min		HPLC-UV	ST	226-30-16	38			
Pipron	OSHA CSI				90		1000		1.5		GC-ECD	F/CST IMP	225-706 225-36-1	96 67	C/HLD IT	225-1 225-22	102 67
Pirimiphos methyl	OSHA PV2071				120		1000		2		GC-ECD	ST	226-30-16	38			
Pithomyces species (fungi, molds, spores)	OSHA CSI				120		1000		2		varies	F/CST	225-3-01	90	C/HLD	225-1	102
Pithomyces species (fungi, molds, spores)	OSHA CSI				141.5		28300		5 min		varies	BI	225-9611	120			
Plaster of Paris (particulates, respirable)	NIOSH 0600	1038			375		2500		2.5		GR	FLT CYC	225-5-37-P 225-01-02	93 111	C/HLD CST	225-1 225-3LF	102 97
Plaster of Paris (particulates, total)	NIOSH 0500	1035			120		2000		1		GR	FLT CST	225-5-37-P 225-2LF	93 97	C/HLD	225-1	102
Plaster of Paris (see dust, respirable nuisance)	OSHA CSI																
Platinum	OSHA ID 130SG				90		1000		1.5		AA	F/CST	225-3-01	90	C/HLD	225-1	102
Platinum (Elements by ICP HNO ₃ Digestion)	NIOSH 7303				200-25,000,000		1000-4000		varies		ICP-AES	F/CST	225-3-01	90	C/HLD	225-1	102
Platinum (as Pt), metal	OSHA CSI				960		2000		8		AA-GF	F/CST	225-3-01	90	C/HLD	225-1	102
Platinum (as Pt), metal	OSHA ID 121				960		2000		8		AA or AES	F/CST	225-3-01	90	C/HLD	225-1	102
Platinum (as Pt), soluble salts	OSHA ID 121		2 µg/m ³		960		2000		8		AA or AES	F/CST	225-3-01	90	C/HLD	225-1	102
PM2.5	EPA IP-10A	1663							9 L/min	24 hrs	GR	CI FLT	225-370 225-1709	117 94	FLT	225-2708	94
PM2.5	EPA IP-10A	1663							10 L/min	24 hrs	GR	PEM	761-203B	114	FLT	225-1709	94
PNA's (Polynuclear Aromatic Hydrocarbons by GC, see specific compounds)	NIOSH 5515	1464			480		2000		4		GC-FID	F/CST C/HLD	225-1713 225-1	94 102	ST	226-30-04	38
PNA's by HPLC (see specific compounds)	NIOSH 5506	1464			480		2000		4		HPLC-UV	F/CST C/HLD	225-1713 225-1	94 102	ST	226-30-04	38
PNA's selected	OSHA 58				960		2000		8		GR & HPLC FD, or GR & HPLC-UV	FLT C/HLD	225-7 225-1	96 102	CST	225-2LF	97
Pollen (in air)					15-150		15000		1-10 min		varies	STC	225-9820	101			
Pollen (in air)	NON 48				62.5-375		12500 +		5-30		varies	BS	225-9595	122	VT	225-9598A	122
Polychlorinated biphenyls	ASTM D 4861	1252			240-7200		1000-5000		4-24		varies	PUF	226-92	or	PUF	226-124	44
Polychlorinated biphenyls	NIOSH 5503		0.001 mg/ m ³ (10 hr)		48		100(200)		8(4)		GC-ECD	FLT ST	225-16 226-39	96 39	CST	225-32	102
Polychlorinated biphenyls	OSHA CSI				60		1000		1		GC-ECD	ST	226-30-16	38			
Polychlorobenzenes (see specific compounds)	NIOSH 5517		varies		varies		varies		8		GC-ECD	FLT CST	225-17-03 Special order	94	ST C/HLD	226-30-04 225-1	38 102
Polychlorobiphenyls (42% Cl)	NIOSH 5503		0.001 mg/ m ³ (10 hr)		48		100(200)		8(4)		GC-ECD	FLT ST	225-16 226-39	96 39	CST	225-32	102
Polychlorobiphenyls (54% Cl)	NIOSH 5503		0.001 mg/ m ³ (10 hr)		48		100(200)		8(4)		GC-ECD	FLT ST	225-16 226-39	96 39	CST	225-32	102
Polycyclic aromatic compounds (PACs), total	NIOSH 5800				960	30	2000	2000	8	15	FLUOR	F/CST C/HLD	225-1713 225-1	94 102	ST	226-30-04	38

Agency standards for OSHA listings represent the OSHA PELs reported in the 29 CFR 1910.1000 Part 1910, Section 1000.

References and abbreviations are found on pages 212-213.

Sampling Guide

www.skinc.com for updates

P

Chemical Hazard	Agency Reference	Chem F File	SAMPLING ∞								Analytical Method	SKC Collecting Equipment & Page Number					
			Agency Standard		Vol. (liter)		Rate (ml/min)		Time								
			TWA	CLG/STEL (ppm)	TWA	CLG/STEL	TWA	CLG/STEL	TWA	CLG/STEL							
Polycyclic aromatic hydrocarbons (PAHs)	EPA IP-7				30,000 L		20 L/min			GC-FID, -MS, HPLC	PUF	226-131	41	FLT	225-1808	95	
Polycyclic aromatic hydrocarbons (PAHs)	EPA TO-13A	1672					220 L/min		24 hrs	GC-MS	PUF	226-131	41	FLT	225-1808	95	
Polyfunctional aziridine	OSHA CSI				100		1000		100 min	GC-FID	ST	226-57		39			
Polynuclear aromatic hydrocarbons (Polynuclear Aromatic Hydrocarbons by GC-MS)	ASTM D 6209		varies		350 m ³ (max)		225 L/min		4-24	GC-MS	PUF	226-131	45	FLT	225-1808	95	
Polynuclear aromatic hydrocarbons by HPLC (see specific compounds)	NIOSH 5506	1464	varies		480		2000		4	HPLC-UV	F/CST C/HLD	225-1713 225-1	94	ST	226-30-04	38	
Polynuclear aromatic hydrocarbons (polynuclear aromatic hydrocarbons by GC, see specific compounds)	NIOSH 5515	1464	varies		480		2000		4	GC-FID	F/CST C/HLD	225-1713 225-1	94	ST	226-30-04	38	
Portland cement (particulates, respirable)	NIOSH 0600	1038			375		2500		2.5	GR	FLT CYC	225-5-37-P 225-01-02	93	C/HLD	225-1 225-3LF	102 97	
Portland cement (particulates, total)	NIOSH 0500	1035			120		2000		1	GR	FLT CST	225-5-37-P 225-2LF	93	C/HLD	225-1	102	
Portland cement (respirable dust) (see Respirable dust)	OSHA ID 142																
Portland cement (total dust)	OSHA ID 207		15 mg/m ³		240		1000		4	XRD	F/CST	225-803	93	C/HLD	225-1	102	
Potassium & compounds	OSHA ID 121				960		2000		8	AA or AES	F/CST	225-3-01	90	C/HLD	225-1	102	
Potassium (Elements by Cellulosic Internal Capsule Sampler)	NIOSH 7306				Varies		1000-4000		Varies	ICP-AES	SC	225-8517	90	C/HLD	225-1	102	
Potassium (Elements by ICP Aqua Regia Ashing)	NIOSH 7301				5-1000		1000-4000		varies	ICP-AES	F/CST C/HLD	225-3-01 225-1	or	F/CST	225-803	93	
Potassium (Elements by ICP HNO ₃ /HClO ₄ Ashing)	NIOSH 7300	1455			5-1000		1000-4000		varies	ICP-AES	F/CST	225-3-01	90	C/HLD	225-1	102	
Potassium chromate (CR(VI))	OSHA ID 215 (V2)	1439	0.005 mg/m ³		960		2000		8	IC-UV	F/CST	225-802 Ω	93	C/HLD	225-1	102	
Potassium cyanide (cyanides)	NIOSH 7904			5 mg/m ³ (10 min)		15		1000		15	ISE	FLT IMP C/HLD	225-2705 Δ 225-36-2 225-1	94	CST	225-2LF 225-22	97 67
Potassium hydroxide (alkaline dust)	NIOSH 7401				960		2000		8	TITRA	F/CST	225-1715	94	C/HLD	225-1	102	
Potassium hydroxide (as K)	OSHA ID 121	1199				10		2000		5	AA or AES	F/CST	225-3-01	90	C/HLD	225-1	102
Pramitol	OSHA CSI				100		1000		100 min	HPLC-UV	ST	226-30-16		38			
Progesterone	OSHA PV2001				60		1000		1	HPLC-UV	F/CST	225-706	96	C/HLD	225-1	102	
Propane	OSHA CSI		1000		5		100		50 min	GC-FID	ST	NA SKC					
1,2,3-Propanetriol trinitrate	OSHA 43				15		1000		15 min	HPLC-UV	ST	226-35-03		39			
n-Propanol	EPA TO-17	1689			1 L & 4 L		16.7 ml/min & 66.7 ml/min			TD, GC	ST CPC	226-300 Series 224-26-CPC	42	TH	224-26-02	51	
Propargyl alcohol	OSHA 97				6		50		2	GC-ECD	ST	226-178		41			
Propazine	ASTM D 4861				240-7200		1000-5000		4-24	GC-NPD	PUF	226-92		44			
Propham (Organonitrogen Pesticides)	NIOSH 5601				240		1000		4	HPLC-UV	ST	226-58	or	ST	226-30-16	38	
Propionaldehyde	ASTM D 5197				varies		500-1200		5 min-24 hrs	HPLC-UV	ST	226-120 °	or	ST	226-119	40	
Propionaldehyde (Aldehydes, Screening)	NIOSH 2539				5		20		4	GC-FID & GC-MS	ST	226-118		40			
Propionic acid	OSHA CSI				10		20(50)		8(3.3)	GC-FID	ST	226-15		38			
Propionitrile	EPA TO-17	1689			1 L & 4 L		16.7 ml/min & 66.7 ml/min			TD, GC	ST CPC	226-300 Series 224-26-CPC	42	TH	224-26-02	51	
Propoxur (Baygon)	ASTM D 4861				240-7200		1000-5000		4-24	HPLC-UV	PUF	226-92		44			
Propoxur (Baygon)	OSHA PV2007				60		1000		1	HPLC-UV	ST	226-30-16		38			
Propoxur (Organonitrogen Pesticides)	NIOSH 5601		0.5 mg/m ³		240		1000		4	HPLC-UV	ST	226-58	or	ST	226-30-16	38	
2-Propoxyethanol	OSHA CSI				6		200		30 min	GC-FID	ST	226-01		38			
n-Propyl acetate	EPA TO-17	1689			1 L & 4 L		16.7 ml/min & 66.7 ml/min			TD, GC	ST CPC	226-300 Series 224-26-CPC	42	TH	224-26-02	51	
n-Propyl acetate	OSHA 07	1136	200		10	3	20(50)	200	8(3.3)	15	GC-FID	ST	226-01		38		
n-Propyl acetate (Esters I)	NIOSH 1450		200	250	1-10	1-10	10-200	10-200	varies	varies	GC-FID	ST	226-01		38		
Propyl alcohol	EPA TO-17	1689			1 L & 4 L		16.7 ml/min & 66.7 ml/min			TD, GC	ST CPC	226-300 Series 224-26-CPC	42	TH	224-26-02	51	
Propyl alcohol	OSHA 07		200		10	3	20(50)	200	8(3.3)	15	GC-FID	ST	226-01		38		
n-Propyl alcohol (alcohols combined)	NIOSH 1405		200	250 (skin)	1-10	1-10	10-200	10-200	varies	varies	GC-FID	ST	226-01		38		
n-Propyl alcohol (alcohols II)	NIOSH 1401		200	250	10	3	20(50)	200	8(3.3)	15	GC-FID	ST	226-01		38		
n-Propyl benzene	EPA TO-17	1689			1 L & 4 L		16.7 ml/min & 66.7 ml/min			TD, GC	ST CPC	226-300 Series 224-26-CPC	42	TH	224-26-02	51	
Propyl bromide	OSHA CSI				12		100		2	GC-FID	ST	226-01		38			
n-Propyl nitrate	OSHA 07		25	40	48		100		8	GC-FID	ST	226-81A		39			
Propyl paraben	OSHA CSI									HPLC-UV	F/CST	225-706	96	C/HLD	225-1	102	
Propylene dichloride (1,2-dichloro propane)	ASTM D 5466				6		varies		varies	GC-MS	CAN	228 Series		PK	228 Series		
Propylene dichloride (1,2-dichloro propane)	NIOSH 1013		LFC		3		20		2.5	GC-ECN	ST	226-81A		39			

Agency standards for OSHA listings represent the OSHA PELs reported in the 29 CFR 1910.1000 Part 1910, Section 1000.

References and abbreviations are found on pages 212-213.

Chemical Hazard	Agency Reference	Chem F File	SAMPLING ∞								Analytical Method	SKC Collecting Equipment & Page Number			
			Agency Standard		Vol. (liter)		Rate (ml/min)		Time						
			TWA (ppm)	CLG/STEL (ppm)	TWA (Sample Time or Air Volume)	CLG/STEL	TWA (Flow/Sampling Rate)	CLG/STEL	TWA (hrs)	CLG/STEL (min)					
Propylene dichloride (1,2-dichloro propane)	OSHA 07		75		10	3		20(50)	200	8(3.3)	15	GC-FID	ST	226-01	38
Propylene glycol	NIOSH 5523	1403			60			1000		1		GC-FID	ST	226-57	39
Propylene glycol	OSHA PV2051				60	15		1000	1000	1	15	GC-FID	ST	226-57	39
1,2-Propylene glycol dinitrate	OSHA CSI				15			1000		15 min		HPLC	ST	226-35-03	39
Propylene glycol monomethyl ether	OSHA CSI				10	3		20(50)	200	8(3.3)	15	GC-FID	ST	226-01	38
Propylene glycol monomethyl ether (glycol ethers)	NIOSH 2554				3-25			100-200		varies		GC-FID	ST	226-81A	39
Propylene glycol monomethyl ether acetate	OSHA CSI				10			20(50)		8(3.3)		GC-FID	ST	226-01	38
Propylene glycol monomethyl ether acetate (glycol ethers)	NIOSH 2554				3-25			100-200		varies		GC-FID	ST	226-81A	39
Propylene oxide (1, 2-epoxypropane)	NIOSH 1612		LFC		5			20		4.2		GC-FID	ST	226-01	38
Propylene oxide (1, 2-epoxypropane)	OSHA 88	1325	100		5	5		100	1000	50 min	5	GC-FID	ST	226-81A	39
Propyleneimine	OSHA CSI		2		48			200		4		HPLC-UV	IMP	225-36-2	67 IT 225-22 67
Pyrene	OSHA 58				960			2000		8		GR & HPLC-FD, or GR & HPLC-UV	FLT 225-7 C/HLD 225-1	96 CST 225-2LF 102	97
Pyrene (Polynuclear Aromatic Hydrocarbons by GC-MS)	ASTM D 6209				350 m ³ (max)			225 L/min		1-24		GC-MS	PUF	226-131	45 FLT 225-1808 95
Pyrene (Polynuclear Aromatic Hydrocarbons by HPLC)	NIOSH 5506				480			2000		4		HPLC-FD	F/CST C/HLD	225-1713 225-1	94 ST 226-30-04 38 102
Pyrethrin pesticides (see specific compounds)	ASTM D 4861				240-7200			1000-5000		4-24		GC-ECD	PUF	226-92	44
Pyrethrum	ASTM D 4861				240-7200			1000-5000		4-24		HPLC-UV	PUF	226-92	44
Pyrethrum	NIOSH 5008		5 mg/m ³		100			1000		2		HPLC-UV	F/CST SP	225-709 225-27	96 C/HLD 225-1 103
Pyrethrum	OSHA 70	1400	5 mg/m ³		60			1000		1		GC-ECD	ST	226-30-16	38
Pyridine	EPA TO-17	1689			1 L & 4 L			16.7 ml/min & 66.7 ml/min				TD, GC	ST CPC	226-300 Series 224-26-CPC	42 TH 224-26-02 51 51
Pyridine	NIOSH 1613		5		48			100		8		GC-FID	ST	226-01	38
Pyridine	OSHA 07	1180	5		48			100		8		GC-FID	ST	226-01	38
Pyridine	OSHA PV2295		5		10			100		100 min		GC-FID	ST	226-95	40
1-(2-Pyridyl)piperazine	OSHA CSI											W	W	225-2401A	140
Pyrimethamine	OSHA CSI				10			1000		100 min		HPLC-UV	F/CST	225-706	96 C/HLD 225-1 102
Quartz (respirable) in coal dust, (silica in coal mine dust)	NIOSH 7603		0.05 mg/m ³		300-1000			2500		varies		IR	FLT 225-5-37-P CYC 225-01-02	93 C/HLD 225-1 111 CST 225-3LF	102 97
Quartz (see Silica, respirable crystalline)	OSHA ID 142														
Quartz (silica, crystalline [respirable]) by XRD	NIOSH 7500	1370	0.05 mg/m ³		400-1000			2500		varies		XRD	F/CST C/HLD	225-803 225-1	93 CYC 225-01-02 111 102
Quartz (silica, crystalline by IR)	NIOSH 7602		0.05 mg/m ³		400-800			2500		varies		IR	F/CST CYC	225-803 225-01-02	93 C/HLD 225-1 111
Quartz (silica, crystalline by VAS)	NIOSH 7601	1041	0.05 mg/m ³		400-800			2500		varies		VAS	F/CST CYC	225-803 225-01-02	93 C/HLD 225-1 111
Quinone	OSHA CSI		0.1		24			100		4		HPLC-UV	ST	226-30-04	38
Rabon	OSHA CSI				480			1000		8		GC-ECD	ST	226-30-16	38
Radon progeny (on dust, in mines)	NON 56				5			2000		5 min		DRI	FLT	225-702	96 CST 225-1107 102
Ramrod (propachlor)	OSHA CSI				120			1000		2		HPLC-UV	F/CST	225-706	96 C/HLD 225-1 102
Resmethrin	ASTM D 4861				240-7200			1000-5000		4-24		HPLC-UV	PUF	226-92	44
Resmethrin	OSHA PV2052				60			1000		1		HPLC-UV	ST	226-30-16	38
Resorcinol	NIOSH 5701		10		120			500		4		GC-FID	ST	226-57	39
Respirable Dust using Aluminum Cyclone	OSHA ID 142		50 µg/m ³		1200			2500		8		GR & XRD	FLT 225-5-37-P C/HLD 225-1	93 CST 225-3050LF 110 CYC 225-01-02	97 97
Respirable Dust using GS-3 Cyclone	OSHA ID 142		50 µg/m ³		1320			2750		8		GR & XRD	FLT 225-5-37-P C/HLD 225-1	93 CST 225-3050LF 110 CYC 225-100	97 97
Respirable Dust using PPI Samplers	OSHA ID 142		50 µg/m ³		960			2000		8		GR & XRD	FLT	225-5-37-P	93 PPI 225-385 112
Rhizopus species (fungi, molds, spores)	OSHA CSI				120			1000		2		varies	F/CST	225-3-01	90 C/HLD 225-1 102
Rhizopus species (fungi, molds, spores)	OSHA CSI				141.5			28300		5 min		varies	BI	225-9611	120
Rhodamine B	OSHA PV2072				240			1000		4		HPLC-UV	F/CST	225-709	96 C/HLD 225-1 102
Rhodium metal fume & dust (as Rh)	OSHA CSI		0.1 mg/m ³		960			2000		8		AA-GF	F/CST	225-3-01	90 C/HLD 225-1 102
Rhodium soluble salts (as Rh)	OSHA CSI		1 µg/m ³		960			2000		8		AA-GF	F/CST	225-3-01	90 C/HLD 225-1 102
Rhodotorula species (fungi, molds, spores)	OSHA CSI				120			1000		2		varies	F/CST	225-3-01	90 C/HLD 225-1 102
Rhodotorula species (fungi, molds, spores)	OSHA CSI				141.5			28300		5 min		varies	BI	225-9611	120
Ribavirin	NIOSH 5027				480			1000		8		HPLC-UV	F/CST	225-709	96 C/HLD 225-1 102
Ronnel	ASTM D 4861				240-7200			1000-5000		4-24		GC-ECD	PUF	226-92	44
Ronnel	OSHA PV2054		15 mg/m ³		60			1000		1		GC-FPD	ST	226-30-16	38
Ronnel (Organophosphorus Pesticides)	NIOSH 5600		10 mg/m ³		60			1000		1		GC-FPD	ST	226-58	39
Rosaniline	OSHA CSI				bulk							HPLC			

Agency standards for OSHA listings represent the OSHA PELs reported in the 29 CFR 1910.1000 Part 1910, Section 1000.

References and abbreviations are found on pages 212-213.

Sampling Guide

www.skinc.com for updates

R

Chemical Hazard	Agency Reference	Chem F File	SAMPLING ∞								Analytical Method	SKC Collecting Equipment & Page Number				
			Agency Standard		Vol. (liter)		Rate (ml/min)		Time							
			TWA (ppm)	CLG/STEL (ppm)	TWA (Sample Time or Air Volume)	CLG/STEL	TWA (Flow/Sampling Rate)	CLG/STEL	TWA (hrs)	CLG/STEL (min)						
Rotenone	NIOSH 5007		5 mg/m ³	120	1000	2		HPLC-UV	FLT C/HLD	225-17-01 225-1	94 102	CST	225-2LF	97		
Rotenone (commercial)	OSHA CSI		5 mg/m ³	240	2000	2		HPLC-UV	FLT C/HLD	225-17-01 225-1	94 102	CST	225-2LF	97		
Rouge (particulates, respirable)	NIOSH 0600	1038		375	2500	2.5		GR	FLT CYC	225-5-37-P 225-01-02	93 111	C/HLD CST	225-1 225-3LF	102 97		
Rouge (particulates, total)	NIOSH 0500	1035		120	2000	1		GR	FLT CST	225-5-37-P 225-2LF	93 97	C/HLD	225-1	102		
Rouge (respirable dust)	OSHA CSI		5 mg/m ³	varies	varies	varies		GR	FLT CYC	225-5-37-P 225-105	93 110	C/HLD CST	225-1 225-3LF	102 97		
Rouge (total dust)	OSHA CSI		15 mg/m ³	960	2000	8		GR	F/CST	225-803	93	C/HLD	225-1	102		
Roundup	OSHA CSI			90	1000	1.5		HPLC-UV	F/CST	225-709	96	C/HLD	225-1	102		
Rozol	OSHA CSI			120	1000	2		HPLC-UV	F/CST	225-706	96	C/HLD	225-1	102		
Rubber solvent (naphthas)	NIOSH 1550		350 mg/m ³ 1800 mg/m ³	10 1.5	20(50) 100	8(3.3) 15		GC-FID	ST	226-01	38					
Rubidium	OSHA CSI			480	1000	8		AA-GF	F/CST IMP	225-709 225-36-2	96 67	C/HLD IT	225-1 225-22	102 67		
Safrotin	OSHA PV2050			60	1000	1		GC-ECD	F/CST	225-709	96	C/HLD	225-1	102		
Saphrophyte (fungi, molds, spores)	OSHA CSI			120	1000	2		varies	F/CST	225-3-01	90	C/HLD	225-1	102		
Saphrophyte (fungi, molds, spores)	OSHA CSI			141.5	28300	5 min		varies	BI	225-9611	120					
Sarin	OSHA CSI			480	1000	8		GC-FPD	ST	226-30-16	38					
Scopolamine methyl nitrate	OSHA PV2144			120	1000	2		HPLC-UV	F/CST C/HLD	225-709 225-1	or 102	F/CST	225-706	96		
Scopulariopsis species (fungi, molds, spores)	OSHA CSI			120	1000	2		varies	F/CST	225-3-01	90	C/HLD	225-1	102		
Scopulariopsis species (fungi, molds, spores)	OSHA CSI			141.5	28300	5 min		varies	BI	225-9611	120					
Selenium	OSHA ID 121		0.2 mg/m ³	960	2000	8		AA or AES	F/CST	225-3-01	90	C/HLD	225-1	102		
Selenium (Elements by Cellulosic Internal Capsule Sampler)	NIOSH 7306		0.2 mg/m ³	2-2000	1000-4000	Varies		ICP-AES	SC	225-8517	90	C/HLD	225-1	102		
Selenium (Elements by ICP Aqua Regia Ashing)	NIOSH 7301		0.2 mg/m ³	13-2000	1000-4000	varies		ICP-AES	F/CST C/HLD	225-3-01 225-1	or 102	F/CST	225-803	93		
Selenium (Elements by ICP HNO ₃ Digestion)	NIOSH 7303		0.2 mg/m ³	8-250,000	1000-4000	varies		ICP-AES	F/CST	225-3-01	90	C/HLD	225-1	102		
Selenium (Elements by ICP HNO ₃ /HClO ₄ Ashing)	NIOSH 7300	1455	0.2 mg/m ³	13-2000	1000-4000	varies		ICP-AES	F/CST	225-3-01	90	C/HLD	225-1	102		
Selenium (Elements on Wipes)	NIOSH 9102			wipe				ICP-AES	W TMP	225-2414 225-2415	140 140	TMP	225-2403	or		
Selenium compounds (as Se)	OSHA CSI		0.2 mg/m ³	960	2000	8		AA-GF	F/CST	225-3-01	90	C/HLD	225-1	102		
Sevin (see carbaryl)																
Sevoflurane	OSHA CSI			3	50	1		GC-FID	ST	226-81A	39					
Silica (quartz) in coal dust (quartz in coal mine dust by IR)	NIOSH 7603		0.05 mg/m ³	300-1000	2500	varies		IR	FLT CYC	225-5-37-P 225-01-02	93 111	C/HLD CST	225-1 225-3LF	102 97		
Silica, amorphous (respirable)	NIOSH 7501		6 mg/m ³	50-400	2500	varies		XRD	F/CST CYC	225-803 225-01-02	93 111	C/HLD	225-1	102		
Silica, crystalline (respirable) by XRD	NIOSH 7500	1370	0.05 mg/m ³	400-1000	2500	varies		XRD	F/CST C/HLD	225-803 225-1	93 102	CYC	225-01-02	111		
Silica, crystalline by IR	NIOSH 7602		0.05 mg/m ³	400-800	2500	varies		IR	F/CST CYC	225-803 225-01-02	93 111	C/HLD	225-1	102		
Silica, crystalline by VAS	NIOSH 7601	1041	0.05 mg/m ³	400-800	2500	varies		VAS	F/CST CYC	225-803 225-01-02	93 111	C/HLD	225-1	102		
Silica, fused (see Silica, respirable crystalline)	OSHA ID 142															
Silica, respirable crystalline (as quartz, cristobalite, tridymite) using Aluminum Cyclone	OSHA ID 142		50 µg/m ³	1200	2500	8		XRD	FLT C/HLD	225-5-37-P 225-1	93 110	CST CYC	225-3050LF 225-01-02	97 97		
Silica, respirable crystalline (as quartz, cristobalite, tridymite) using GS-3 Cyclone	OSHA ID 142		50 µg/m ³	1320	2750	8		XRD	FLT C/HLD	225-5-37-P 225-1	93 110	CST CYC	225-3050LF 225-100	97 97		
Silica, respirable crystalline (as quartz, cristobalite, tridymite) using PPI Samplers	OSHA ID 142		50 µg/m ³	960	2000	8		XRD	FLT	225-5-37-P	93	PPI	225-385	112		
Silicon	OSHA CSI		15 mg/m ³	960	2000	8		GR	F/CST	225-803	93	C/HLD	225-1	102		
Silicon (particulates, respirable)	NIOSH 0600	1038		375	2500	2.5		GR	FLT CYC	225-5-37-P 225-01-02	93 111	C/HLD CST	225-1 225-3LF	102 97		
Silicon (particulates, total)	NIOSH 0500	1035		120	2000	1		GR	FLT CST	225-5-37-P 225-2LF	93 97	C/HLD	225-1	102		
Silicon (respirable dust)	OSHA CSI		5 mg/m ³	varies	varies	varies		GR	FLT CYC	225-5-37-P 225-105	93 110	C/HLD CST	225-1 225-3LF	102 97		
Silicon carbide (particulates, respirable)	NIOSH 0600	1038		375	2500	2.5		GR	FLT CYC	225-5-37-P 225-01-02	93 111	C/HLD CST	225-1 225-3LF	102 97		
Silicon carbide (particulates, total)	NIOSH 0500	1035		120	2000	1		GR	FLT CST	225-5-37-P 225-2LF	93 97	C/HLD	225-1	102		
Silicon carbide (respirable dust)	OSHA CSI		5 mg/m ³	varies	varies	varies		GR	FLT CYC	225-5-37-P 225-105	93 110	C/HLD CST	225-1 225-3LF	102 97		
Silicon carbide (total dust)	OSHA CSI		15 mg/m ³	960	2000	8		GR	F/CST	225-803	93	C/HLD	225-1	102		

Agency standards for OSHA listings represent the OSHA PELs reported in the 29 CFR 1910.1000 Part 1910, Section 1000.

References and abbreviations are found on pages 212-213.

Chemical Hazard	Agency Reference	Chem F File	SAMPLING ∞								Analytical Method	SKC Collecting Equipment & Page Number							
			Agency Standard		Vol. (liter)		Rate (ml/min)		Time										
			TWA (ppm)	CLG/STEL (ppm)	TWA (Sample Time or Air Volume)	CLG/STEL	TWA (Flow/Sampling Rate)	CLG/STEL	TWA (hrs)	CLG/STEL (min)									
Silicon tetrahydride (silane)	OSHA CSI				480		1000			8		AA-GF	IMP	225-36-2	67	IT	225-22	67	
Silver (Elements by Cellulosic Internal Capsule Sampler)	NIOSH 7306		0.01 mg/m ³		6-2000		1000-4000			Varies		ICP-AES	SC	225-8517	90	C/HLD	225-1	102	
Silver (Elements by ICP Aqua Regia Ashing)	NIOSH 7301				250-2000		1000-4000			varies		ICP-AES	F/CST	225-3-01	or	F/CST	225-803	93	
Silver (Elements by ICP HNO ₃ /HClO ₄ , Ashing)	NIOSH 7300	1455	0.01 mg/m ³ (metal, sol)		250-2000		1000-4000			varies		ICP-AES	F/CST	225-3-01		90	C/HLD	225-1	102
Silver (Elements on Wipes)	NIOSH 9102				wipe							ICP-AES	W	225-2414		140	TMP	225-2403	or
Silver, metal & soluble compounds (as Ag)	OSHA ID 121	1198	0.01 mg/m ³		960		2000			8		AA or AES	F/CST	225-3-01		90	C/HLD	225-1	102
Silver, metal & soluble compounds (ICP analysis of metal/metalloid particulates from solder operations)	OSHA ID 206	1279	0.01 mg/m ³		960		2000			8		ICP-AES	F/CST	225-3-01		90	C/HLD	225-1	102
Silvex	OSHA CSI											W	W	225-2401A		140			
Simazine	ASTM D 4861				240-7200		1000-5000			4-24		HPLC-UV	PUF	226-92		44			
Simazine	NIOSH 5602				480		1000			8		GC-ECD	ST	226-58		39			
Simazine	OSHA CSI				120		1000			2		HPLC-UV	F/CST	225-706		96	C/HLD	225-1	102
Soapstone (respirable dust)	OSHA CSI		20 mppcf		varies		varies			varies		GR	FLT	225-5-37-P		93	C/HLD	225-1	102
Soapstone (total dust)	OSHA CSI		20 mppcf		960		2000			8		GR	FLT	225-5-37-P		93	C/HLD	225-1	102
Sodium azide	OSHA ID 211					5		1000		5		IC-UV	ST	226-55		39	FLT	225-5-37-P	93
Sodium bisulfite	OSHA ID 121	1203			960		2000			8		AA or AES	F/CST	225-3-01		90	C/HLD	225-1	102
Sodium carbonate (see dust, respirable nuisance)	OSHA CSI																		
Sodium fluoride (fluorides)	NIOSH 7902		2.5 mg/m ³		480	30	1000	2000		8	15	ISE	CF/CST	225-9001		64	C/HLD	225-1	102
Sodium fluoride (fluorides)	NIOSH 7906		2.5 mg/m ³		960	30	2000	2000		8	15	IC-CD	CF/CST	225-9031		64	C/HLD	225-1	102
Sodium fluoroacetate	OSHA CSI		0.05 mg/m ³		960	30	2000	2000		8	15	AA	F/CST	225-3-01		90	C/HLD	225-1	102
Sodium hexafluoroaluminate (fluorides)	NIOSH 7902		2.5 mg/m ³		480	30	1000	2000		8	15	ISE	CF/CST	225-9001		64	C/HLD	225-1	102
Sodium hexafluoroaluminate (fluorides)	NIOSH 7906		2.5 mg/m ³		960		2000			8		IC-CD	CF/CST	225-9031		64	C/HLD	225-1	102
Sodium hydroxide	OSHA ID 121	1042	2 mg/m ³		960	30	2000	2000		8	15	AA or AES	F/CST	225-3-01		90	C/HLD	225-1	102
Sodium hydroxide (alkaline dust)	NIOSH 7401			2 mg/m ³ (15 min)	360		1500			4		TITRA	F/CST	225-1715		94	C/HLD	225-1	102
Sodium metabisulfite	OSHA ID 121				960		2000			8		AA or AES	F/CST	225-3-01		90	C/HLD	225-1	102
Sodium metasilicate	OSHA CSI											NVM	F/CST	225-3-01		90	C/HLD	225-1	102
Sodium nitrate	OSHA CSI				960		2000			8		AA or IC	F/CST	225-3-01		90	C/HLD	225-1	102
Sodium nitrite	OSHA CSI				960		2000			8		AA or IC	F/CST	225-3-01		90	C/HLD	225-1	102
Sodium o-phenyl phenate	OSHA CSI				10		20(50)			8(3.3)		GC-FID	F/CST	225-706		96	ST	226-35	38
Sodium polyacrylate (see super absorbent polymer)																			
Solanesol (environmental tobacco smoke, respirable particles)	ASTM D 6271				150-3600		2500			1-24		HPLC-UV	FLT	225-2705		94	CST	225-3LF	97
Solder fume (ICP analysis of metal/metalloid particulates from solder operations)	OSHA ID 206				480		2000			4		ICP-AES	F/CST	225-3-01		90	C/HLD	225-1	102
Soot (see elemental carbon)	NIOSH 5040											TOA-FID							
Spores (bacterial, fungal) (in air)					15-150		15000			1-10 min		varies	STC	225-9820		101			
Spores (bacterial, fungal) (in air)	NON 48				62.5-375		12500 +			5-30		varies	BS	225-9595		122	VT	225-9598A	122
Sporothrix species (fungi, molds, spores)	OSHA CSI				120		1000			2		varies	F/CST	225-3-01		90	C/HLD	225-1	102
Sporothrix species (fungi, molds, spores)	OSHA CSI				141.5		28300			5 min		varies	BI	225-9611		120			
Stachybotrys chartarum (fungi, molds, spores)	OSHA CSI				120		1000			2		varies	F/CST	225-3-01		90	C/HLD	225-1	102
Stachybotrys chartarum (fungi, molds, spores)	OSHA CSI				141.5		28300			5 min		varies	BI	225-9611		120			
Stachybotrys species (fungi, molds, spores)	OSHA CSI				120		1000			2		varies	F/CST	225-3-01		90	C/HLD	225-1	102
Stachybotrys species (fungi, molds, spores)	OSHA CSI				141.5		28300			5 min		varies	BI	225-9611		120			
Stannous-2-ethyl hexanoate (tin, organic compounds [as Sn])	OSHA CSI				480		1000			8		AA-GF	ST	226-30-16		38			
Starch (particulates, respirable)	NIOSH 0600	1038			375		2500			2.5		GR	FLT	225-5-37-P		93	C/HLD	225-1	102
Starch (particulates, total)	NIOSH 0500	1035			120		2000			1		GR	CYC	225-01-02		111	CST	225-3LF	97
Starch (see dust, total and respirable nuisance)																			
Stoddard solvent	OSHA 48		500		3		200			15 min		GC-FID	ST	226-01		38			
Stoddard solvent (naphthas)	NIOSH 1550		350 mg/m ³ 1800 mg/m ³		10	1.5	20(50)	100		8(3.3)	15	GC-FID	ST	226-01		38			
Strontium	OSHA CSI				480		1000			8		AA	F/CST	225-3-01		90	C/HLD	225-1	102

Agency standards for OSHA listings represent the OSHA PELs reported in the 29 CFR 1910.1000 Part 1910, Section 1000.

References and abbreviations are found on pages 212-213.

Sampling Guide

www.skinc.com for updates

S

Chemical Hazard	Agency Reference	Chem F File	SAMPLING ∞								Analytical Method	SKC Collecting Equipment & Page Number			
			Agency Standard		Vol. (liter)		Rate (ml/min)		Time						
			TWA (ppm)	CLG/STEL (ppm)	TWA (Sample Time or Air Volume)	CLG/STEL	TWA (Flow/Sampling Rate)	CLG/STEL	TWA (hrs)	CLG/STEL (min)					
Strontium (Elements by Cellulosic Internal Capsule Sampler)	NIOSH 7306				Varies		1000-4000		Varies	ICP-AES	SC 225-8517	90 C/HLD 225-1	102		
Strontium (Elements by ICP Aqua Regia Ashing)	NIOSH 7301				10-1000		1000-4000		varies	ICP-AES	F/CST 225-3-01 or 225-1	90 F/CST 225-803 ¥	93		
Strontium (Elements by ICP HNO ₃ Digestion)	NIOSH 7303				300-100,000,000		1000-4000		varies	ICP-AES	F/CST 225-3-01	90 C/HLD 225-1	102		
Strontium (Elements by ICP HNO ₃ /HClO ₄ Ashing)	NIOSH 7300	1455	0.5 mg/m ³		10-1000		1000-4000		varies	ICP-AES	F/CST 225-3-01	90 C/HLD 225-1	102		
Strontium (Elements on Wipes)	NIOSH 9102				wipe					ICP-AES	W 225-2414 TMP 225-2415	140 TMP 225-2403 or 140			
Strychnine	NIOSH 5016		0.15 mg/m ³ (10 hr)		180		1500		2	HPLC-UV	F/CST 225-706	96 C/HLD 225-1	102		
Strychnine	OSHA CSI		0.15 mg/m ³		1000		3000		5.5	HPLC-UV	F/CST 225-709	96 C/HLD 225-1	102		
Styrene	EPA TO-17	1689			1 L & 4 L		16.7 ml/min & 66.7 ml/min			TD, GC	ST 226-300 Series CPC 224-26-CPC	42 TH 224-26-02 51	51		
Styrene (phenylethylene)	ASTM D 5466				6		varies		varies	GC-MS	CAN 228 Series	PK 228 Series			
Styrene (phenylethylene)	NON 54				10	3	20	200	8	15	GC-FID	ST 226-81A	39		
Styrene (phenylethylene)	OSHA 09		100	200 (C)	10	3	20(50)	200	8(3.3)	15	GC-FID	ST 226-01	38		
Styrene (phenylethylene)	OSHA 1014		100	200 (C)			13.55	13.55	8	15	HPLC-UV	PS 575-006	75		
Styrene (phenylethylene)	OSHA 89	1368	100	200 (C)	12	0.75	50	50	4	15	GC-FID	ST 226-73	39		
Styrene (phenylethylene) (Hydrocarbons, Aromatic)	NIOSH 1501		50	100	1-14	1-14	10-1000	10-1000	varies	varies	GC-FID	ST 226-01	38		
Styrene oxide	OSHA CSI				10		20(50)		8(3.3)		GC-FID	ST 226-35	38		
Subtilisins (proteolytic enzymes)	OSHA CSI										Bulk				
Sucrose (particulates, respirable)	NIOSH 0600	1038			375		2500		2.5		GR	FLT 225-5-37-P CYC 225-01-02	93 C/HLD 225-1 111 CST 225-3LF	102 97	
Sucrose (particulates, total)	NIOSH 0500	1035			120		2000		1		GR	FLT 225-5-37-P CST 225-2LF	93 C/HLD 225-1 97	102	
Sucrose (see dust, total or dust, respirable nuisance)	OSHA CSI														
Sudan I	OSHA CSI				90		1000		2		HPLC-UV	F/CST 225-709	96 C/HLD 225-1	102	
Sudan III	OSHA CSI				90		1000		1.5		HPLC	F/CST 225-709	96 C/HLD 225-1	102	
Sulfamethazine	OSHA CSI				100		1000		1.5		HPLC-UV	F/CST 225-706	96 C/HLD 225-1	102	
Sulfamic acid	OSHA CSI				100		1000		100 min		IC	F/CST 225-709	96 C/HLD 225-1	102	
m-Sulfobenzoic acid	OSHA CSI				180		1000		3		HPLC-UV	F/CST 225-3-01	90 C/HLD 225-1	102	
Sulfur (see dust, total & respirable nuisance)															
Sulfur dioxide	NIOSH 6004	1331	2	5	180	15	1000	1000	3	15	IC	CF/CST 225-9005	64 C/HLD 225-1	102	
Sulfur dioxide	OSHA 1011		5 ppm		12	7.5	50	500	4	15	IC	ST 226-177	41		
Sulfur dioxide	OSHA ID 104		5		60	15	1000	1000	1	15	IC	F/CST 225-3-01 IT 225-22	90 IMP 225-36-2 67	67	
Sulfur dioxide	OSHA ID 200	1461	5		12	1.5	100	100	2	15	IC	ST 226-80	39		
Sulfur dioxide (using prefilter)	OSHA ID 200	1622	5		12	1.5	100	100	2	15	IC	ST 226-80 CST 225-3-23	39 FLT 225-2708 97 C/HLD 225-1	94 102	
Sulfur hexafluoride by portable GC	NIOSH 6602	1023	1000		varies		20-100		varies		P GC-ECD	SB 232-03	or SB 231-03	54	
Sulfur monochloride	OSHA CSI				1		5	1000		5	IC	IMP 225-36-2	67 IT 225-22	67	
Sulfur tetrafluoride	OSHA ID 110					5		1000		5	ISE	IMP 225-36-2	67 IT 225-22	67	
Sulfuric acid	NIOSH 7908		0.2 mg/m ³ *		960		2000		8		IC	PPI 225-381 IS 225-388	112 FLT 225-1827 95 SP 225-27	88 103	
Sulfuric acid	NIOSH 7908		1 mg/m ³		960		2000		8		IC-CD	CF/CST 225-9033	64 C/HLD 225-1	102	
Sulfuric acid	OSHA ID 113	1465	1 mg/m ³		480		2000		4		IC	F/CST 225-3-01	90 C/HLD 225-1	102	
Sulfuric acid	OSHA ID 113		0.2 mg/m ³ *		480		2000		4		IC	PPI 225-381 IS 225-388	112 FLT 225-5 95 SP 225-27	88 103	
Sulfuric acid	OSHA ID 16SSG		1 mg/m ³		96		200		8		IC	ST 226-10-03	38		
Sulfuric acid mist	ASTM D 4856	1431			40		1000		40 min		IC	F/CST 225-3-01	90 C/HLD 225-1	102	
Sulfuryl fluoride	NIOSH 6012		5	10	10		20		8		IC-CD	ST 226-16	38		
Sulfuryl fluoride	OSHA CSI		5		24	1.5	100	100	4	15	IC	ST 226-16	38		
Sulprofos	OSHA PV2037				240		1000		4		GC-FPD	ST 226-30-16	38		
Sulprofos (Organophosphorus Pesticides)	NIOSH 5600		1 mg/m ³		240		1000		4		GC-FPD	ST 226-58	39		
Super absorbent polymers	NIOSH 5035				960		2000		8		ICP-AES or AA	F/CST 225-802	93 C/HLD 225-1	102	
Syncephalastrum species (fungi, molds, spores)	OSHA CSI				120		1000		2		varies	F/CST 225-3-01	90 C/HLD 225-1	102	
Syncephalastrum species (fungi, molds, spores)	OSHA CSI				141.5		28300		5 min		varies	BI 225-9611	120		
Systox (see demeton)															
2,4,5-T	OSHA CSI		10 mg/m ³		200		3000		1		HPLC-UV	F/CST 225-706	96 C/HLD 225-1	102	
Talc (containing asbestos) (see asbestos)	OSHA ID 160														
Talc (respirable, with no asbestos)	OSHA CSI		20 mppcf		varies		varies		varies		GR	FLT 225-5-37-P CYC 225-105	93 C/HLD 225-1 110 CST 225-3LF	102 97	

Agency standards for OSHA listings represent the OSHA PELs reported in the 29 CFR 1910.1000 Part 1910, Section 1000.

References and abbreviations are found on pages 212-213.

Chemical Hazard	Agency Reference	Chem F File	SAMPLING ∞								Analytical Method	SKC Collecting Equipment & Page Number					
			Agency Standard		Vol. (liter)		Rate (ml/min)		Time								
			TWA (ppm)	CLG/STEL (ppm)	TWA (Sample Time or Air Volume)	CLG/STEL	TWA (Flow/Sampling Rate)	CLG/STEL	TWA (hrs)	CLG/STEL (min)							
Tannin	OSHA CSI			60		1000		1		HPLC-UV	F/CST	225-706	96	C/HLD	225-1	102	
Tantalum (metal, oxide dusts)	OSHA CSI		5 mg/m ³	960		2000		8		GR	F/CST	225-803	93	C/HLD	225-1	102	
2,4-TDI (toluene diisocyanate)	ASTM D 5932			15		1000		15		HPLC-UV-FD	CF/CST	225-9022	64	C/HLD	225-1	102	
2,4-TDI (toluene diisocyanate)	NIOSH 5522		LFC	360	20	1000	2000	6	10	HPLC-FD	IMP	225-36-1	67	IT	225-22	67	
2,4-TDI (toluene diisocyanate)	OSHA 42	1458		0.02 (C)	240	15	1000	1000	4	15	HPLC-UV or HPLC-FD	CF/CST or C/HLD	225-9002 or 225-1	or 102	CF/CST	225-9013	64
2,6-TDI (toluene diisocyanate)	ASTM D 5932			15		1000		15		HPLC-UV-FD	CF/CST	225-9022	64	C/HLD	225-1	102	
2,6-TDI (toluene diisocyanate)	NIOSH 5522		LFC	360	20	1000	2000	6	10	HPLC-FD	IMP	225-36-1	67	IT	225-22	67	
2,6-TDI (toluene diisocyanate)	OSHA 42	1458			15		2000		15	HPLC-UV or HPLC-FD	CF/CST or C/HLD	225-9002 or 225-1	or 102	CF/CST	225-9013	64	
2,4-TDI (Toluene diisocyanate) (isocyanates)	OR-OSHA 1010		0.02	0.005	45	5	1000	1000	45 min	5	HPLC	IMP	225-36-1	67	IT	225-22	67
2,6-TDI (Toluene diisocyanate) (isocyanates)	OR-OSHA 1010		0.02	0.005	45	5	1000	1000	45 min	5	HPLC	IMP	225-36-1	67	IT	225-22	67
2, 4-TDI (toluene diisocyanate) (isocyanates, total)	NIOSH 5525		LFC		1-500		1000-2000		varies		HPLC-UV	FLT	225-7 ‡	96	CST	225-4	97
												SP	225-27	or 96	IOM	225-76A	108
												FLT	225-702 ‡	96			
2, 6-TDI (toluene diisocyanate) (isocyanates, total)	NIOSH 5525		LFC		1-500		1000-2000		varies		HPLC-UV	FLT	225-7 ‡	96	CST	225-4	97
												SP	225-27	or 96	IOM	225-76A	108
												FLT	225-702 ‡	96			
TEDP	OSHA CSI		0.2 mg/m ³	480		1000		8		GC-FPD	ST	226-30-16	38				
Tellurium	OSHA ID 121		0.1 mg/m ³	960		2000		8		AA or AES	F/CST	225-3-01	90	C/HLD	225-1	102	
Tellurium	OSHA ID 1325G	1215	0.1 mg/m ³	100 to 1000		1500 to 2000		varies		AA-GF	F/CST	225-3-01	90	C/HLD	225-1	102	
Tellurium (Elements by Cellulosic Internal Capsule Sampler)	NIOSH 7306			7-2000		1000-4000		Varies		ICP-AES	SC	225-8517	90	C/HLD	225-1	102	
Tellurium (Elements by ICP Aqua Regia Ashing)	NIOSH 7301		0.1 mg/m ³	25-2000		1000-4000		varies		ICP-AES	F/CST	225-3-01	or 102	F/CST	225-803	93	
Tellurium (Elements by ICP HNO ₃ Digestion)	NIOSH 7303		0.1 mg/m ³	125-500,000		1000-4000		varies		ICP-AES	F/CST	225-3-01	90	C/HLD	225-1	102	
Tellurium (Elements by ICP HNO ₃ /HClO ₄ Ashing)	NIOSH 7300	1455	0.1 mg/m ³	25-2000		1000-4000		varies		ICP-AES	F/CST	225-3-01	90	C/HLD	225-1	102	
Tellurium (Elements on Wipes)	NIOSH 9102			wipe						ICP-AES	W	225-2414	140	TMP	225-2403	or 140	
											TMP	225-2415	140				
Tellurium hexafluoride (as Te)	OSHA CSI		0.02	480		1000		8		AA	ST	226-01	38	F/CST	225-3-01	90	
Temephos (respirable dust)	OSHA PV2056		5 mg/m ³	varies		varies		varies		GC-FPD	F/CST	225-706	96	C/HLD	225-1	102	
Temephos (total dust)	OSHA CSI		15 mg/m ³	480		1000		8		GC-FPD	ST	226-30-16	38				
TEPP	OSHA CSI		0.05 mg/m ³	480		1000		8		GC-FPD	ST	226-30-16	38				
Terbufos	OSHA CSI			480		1000		8		GC-FPD	ST	226-30-16	38				
Terbufos (Organophosphorus Pesticides)	NIOSH 5600			240		1000		4		GC-FPD	ST	226-58	39				
Terbutiuron	ASTM D 4861			240-7200		1000-5000		4-24		HPLC-UV	PUF	226-92	44				
Tergitol NP-33	OSHA CSI			100		1000		1.6		HPLC-UV	ST	226-57	39				
Terpenes (screening)	NIOSH 2549			5		20		4		GC-MS	ST	226-330	42				
Terpenes (see specific compounds)	NIOSH 1552	1463		24		50		8		GC-FID	ST	226-01	38				
o-Terphenyl	NIOSH 5021		0.5	30		2000		15		GC-FID	F/CST	225-1713	94	C/HLD	225-1	102	
o-Terphenyl (see terphenyls)	OSHA CSI																
Terphenyls	OSHA CSI		1 (C)	8.5		1700		5		HPLC-FD	F/CST	225-709	96	C/HLD	225-1	102	
Terpineol	OSHA CSI			10		200		50 min		GC-FID	ST	226-01	38				
Testosterone	OSHA PV2001			60		1000		1		HPLC-UV	F/CST	225-706	96	C/HLD	225-1	102	
Tetrabromobisphenol A	OSHA CSI			100		1000		100 min		HPLC-UV	F/CST	225-706	96	C/HLD	225-1	102	
1,1,2,2-Tetrabromoethane	NIOSH 2003			96		200		8		GC-FID	ST	226-10	38				
Tetrabutyltin (organotin compounds as Sn)	NIOSH 5504		0.1 mg/m ³	480		1000		8		HPLC & AA-GF	ST	226-30	38	F/CST	225-709	96	
											C/HLD	225-1	102				
1,1,2,2-Tetrachloro-1,2-difluoroethane	NIOSH 1016		500	2		20		1.5		GC-FID	ST	226-01	38				
1,1,2,2-Tetrachloro-1,2-difluoroethane	OSHA 07	1182	500	2		50		40 min		GC-FID	ST	226-01	38				
1,1,1,2-Tetrachloro-2,2-difluoroethane	NIOSH 1016		500	2		20		1.5		GC-FID	ST	226-01	38				
1,1,1,2-Tetrachloro-2,2-difluoroethane	OSHA 07	1181	500	2		50		40 min		GC-FID	ST	226-01	38				
1,2,3,4-Tetrachlorobenzene	ASTM D 4861			240-7200		1000-5000		4-24		GC-ECD	PUF	226-124	44				
1,2,3,5-Tetrachlorobenzene	OSHA CSI			12		100		2		GC-ECD	FLT	225-17-03	94	CST	Special order		
											ST	226-30-04	38	C/HLD	225-1	102	
1,2,4,5-Tetrachlorobenzene (polychlorobenzenes)	NIOSH 5517			12		25		8		GC-ECD	FLT	225-17-03	94	CST	Special order		
											ST	226-30-04	38	C/HLD	225-1	102	
2,3,7,8-Tetrachlorodibenzofuran	OSHA CSI			30		1000		0.5		NVM	IMP	225-36-1	67	IT	225-22	67	
2,3,7,8-Tetrachlorodibenzo-p-dioxin	OSHA CSI			30		1000		0.5		NVM	IMP	225-36-1	67	IT	225-22	67	

Agency standards for OSHA listings represent the OSHA PELs reported in the 29 CFR 1910.1000 Part 1910, Section 1000.

References and abbreviations are found on pages 212-213.

Sampling Guide

www.skinc.com for updates

T

Chemical Hazard	Agency Reference	Chem F File	SAMPLING ∞								Analytical Method	SKC Collecting Equipment & Page Number						
			Agency Standard		Vol. (liter)		Rate (ml/min)		Time									
			TWA (ppm)	CLG/STEL (ppm)	TWA (Sample Time or Air Volume)	CLG/STEL	TWA (Flow/Sampling Rate)	CLG/STEL	TWA (hrs)	CLG/STEL (min)								
1,1,1,2-Tetrachloroethane	EPA TO-17	1689			1 L & 4 L		16.7 ml/min & 66.7 ml/min				TD, GC	ST CPC	226-300 Series 224-26-CPC	42 51	TH	224-26-02	51	
1,1,2,2-Tetrachloroethane	ASTM D 5466				6		varies		varies		GC-MS	CAN	228 Series		PK	228 Series		
1,1,2,2-Tetrachloroethane	EPA TO-17	1689			1 L & 4 L		16.7 ml/min & 66.7 ml/min				TD, GC	ST CPC	226-300 Series 224-26-CPC	42 51	TH	224-26-02	51	
1,1,2,2-Tetrachloroethane	NIOSH 1019		1		24		50		8		GC-FID	ST	226-81A			39		
1,1,2,2-Tetrachloroethane	NIOSH 2562		1		3-30		10-200		varies		GC-FID	ST	NA SKC					
1,1,2,2-Tetrachloroethane	OSHA 07		5		30		200		2.5		GC-FID	ST	226-81A			39		
Tetrachloroethylene	EPA TO-17	1689			1 L & 4 L		16.7 ml/min & 66.7 ml/min				TD, GC	ST CPC	226-300 Series 224-26-CPC	42 51	TH	224-26-02	51	
Tetrachloroethylene	Indoor	1689					13.1 ml/min		8-24 hrs		TD, GC	PS PS	690-101 690-104	or 84	PS	690-103	or	
Tetrachloroethylene (hydrocarbons, halogenated)	NIOSH 1003			LFC	3		10-200		varies		GC-FID	ST	226-01			38		
Tetrachloroethylene (perchloroethylene)	ASTM D 5466				6		varies		varies		GC-MS	CAN	228 Series		PK	228 Series		
Tetrachloroethylene (perchloroethylene)	OSHA 07			100	200	24	50		8		GC-FID	ST	226-01			38		
Tetrachloroethylene (perchloroethylene)	OSHA 1001	1747		100	200 (C)	12	0.75	50	50	4	5	GC-FID	ST	226-01			38	
Tetrachloroethylene (perchloroethylene)	OSHA 1001	1747		100	200 (C)			13.06		8	5	GC-FID	PS	575-002			75	
Tetrachloroethylene (perchloroethylene) (portable GC)	NIOSH 3704			LFC	1		20-5000		varies		P GC	SB	232-01			55		
Tetrachloronaphthalene	OSHA CSI			2 mg/m³		90		1000		1.5		GC-FID	ST	226-30-16			38	
2,3,4,6-Tetrachlorophenol	OSHA 45					48		200		4		HPLC-UV	ST	226-97			40	
Tetraethyl lead (as Pb)	NIOSH 2533			0.075 mg/m³		120		1000		2		GC-PID	ST	226-30-04			38	
Tetraethyl lead (as Pb)	OSHA CSI			75 µg/m³		480		1000		8		AA	ST C/HLD	226-01 225-1	38	F/CST	225-706	96
Tetraethyl pyrophosphate	NIOSH 2504			0.05 mg/m³		24		50		8		GC-FPD	ST	NA SKC				
Tetraethyl tin	OSHA 110			0.1 mg/m³		48	3	200	200	4	15	GC-FID	ST	226-95			40	
Tetraethylene glycol	NIOSH 5523					60		1000		1		GC-FID	ST	226-57			39	
Tetraethylene glycol diacrylate	OSHA CSI					10		20(50)		8(3.3)		HPLC-UV	ST	226-95			40	
Tetraethylene glycol dimethacrylate	OSHA CSI					10		20(50)		8(3.3)		GC-FID	ST	226-95			40	
Tetraethylenepentamine	OSHA CSI					15		1000		15		HPLC-UV	FLT C/HLD	225-7 ‡ 225-1	96	CST	225-2LF	97
Tetrahydrofuran	NIOSH 1609		200	250	9	1.5	20(50)	100	7(3)	15		GC-FID	ST	226-01			38	
Tetrahydrofuran	OSHA 07	1064	200		10	3	20(50)	200	8(3.3)	15		GC-FID	ST	226-01			38	
Tetrahydrofurfuryl acrylate	OSHA PV2131			1 mg/m³		48		200		4		GC-FID	ST	226-110			40	
Tetrakis(hydroxymethyl)phosphonium chloride	NIOSH 5046					1-480		1000-1700		varies		HPLC-UV	CF/CST	225-9003			64	
Tetramethyl lead (as Pb)	NIOSH 2534			75 µg/m³		96		200		8		GC-PID	ST	226-30-06			38	
Tetramethyl lead (as Pb)	OSHA CSI			75 µg/m³		480		1000		8		AA	F/CST C/HLD	225-709 225-1	96	ST	226-01	38
Tetramethyl succinonitrile	OSHA 07	1183	0.5		10		20		8			GC-FID	ST	226-01			38	
Tetramethyl thiourea disulfide (see thiram)																		
Tetramethyl thiourea	NIOSH 3505					96		200		8		VAS	IMP	225-36-1	67	IT	225-22	67
Tetramethyl tin	OSHA PV2057			0.1 mg/m³		20		200		100 min		GC-FID	ST	226-01			38	
1,2,3,4-Tetramethylbenzene	OSHA CSI					10		20(50)		8(3.3)		GC-FID	ST	226-01			38	
1,2,3,5-Tetramethylbenzene	OSHA CSI					10		20(50)		8(3.3)		GC-FID	ST	226-01			38	
1,2,4,5-Tetramethylbenzene	OSHA CSI					10		20(50)		8(3.3)		GC-FID	ST	226-01			38	
Tetramethyldiaminobenzophenone	OSHA CSI					180		1000		3		HPLC-UV	F/CST	225-709	96	C/HLD	225-1	102
N,N,N',N'-Tetramethylethylenediamine	OSHA CSI					480		1000		8		GC-NPD	IMP	225-36-1	67	IT	225-22	67
Tetranitromethane	NIOSH 3513		1		240		1000		4			GC-NPD	IMP	225-36-1	67	IT	225-22	67
Tetranitromethane	OSHA CSI		1		240		1000		4			GC-NPD	IMP	225-36-1	67	IT	225-22	67
Tetrasodium pyrophosphate	OSHA ID 111					960		2000		8		GR & IC	FLT CST	225-5-37-P 225-2LF	93	C/HLD	225-1	102
Tetrasodium pyrophosphate	OSHA ID 121					960		2000		8		AA or AES	FLT CST	225-5-37-P 225-2LF	93	C/HLD	225-1	102
Tetryl (2,4,6-trinitrophenyl-methylnitramine)	OSHA CSI			1.5 mg/m³		90		1500		1		CLR	F/CST	225-3-01	90	C/HLD	225-1	102
Thallium (Elements by ICP Aqua Regia Ashing)	NIOSH 7301			0.1 mg/m³ (skin, sol)		25-2000		1000-4000		varies		ICP-AES	F/CST C/HLD	225-3-01 225-1	or 102	F/CST	225-803	93
Thallium (Elements by Cellulosic Internal Capsule Sampler)	NIOSH 7306			0.1 mg/m³ (skin)		7-2000		1000-4000		Varies		ICP-AES	SC	225-8517	90	C/HLD	225-1	102
Thallium (Elements by ICP HNO ₃ Digestion)	NIOSH 7303			0.1 mg/m³ (skin, sol)		35-500,000		1000-4000		varies		ICP-AES	F/CST	225-3-01	90	C/HLD	225-1	102
Thallium (Elements by ICP HNO ₃ /HClO ₄ Ashing)	NIOSH 7300	1455		0.1 mg/m³ (skin, sol)		25-2000		1000-4000		varies		ICP-AES	F/CST	225-3-01	90	C/HLD	225-1	102
Thallium (Elements on Wipes)	NIOSH 9102					wipe						ICP-AES	W TMP	225-2414 225-2415	140	TMP	225-2403	or 140

Agency standards for OSHA listings represent the OSHA PELs reported in the 29 CFR 1910.1000 Part 1910, Section 1000.

References and abbreviations are found on pages 212-213.

Chemical Hazard	Agency Reference	Chem F File	SAMPLING ∞								Analytical Method	SKC Collecting Equipment & Page Number								
			Agency Standard		Vol. (liter)		Rate (ml/min)		Time											
			TWA (ppm)	CLG/STEL (ppm)	TWA (Sample Time or Air Volume)	CLG/STEL	TWA (Flow/Sampling Rate)	CLG/STEL	TWA (hrs)	CLG/STEL (min)										
Thallium (soluble compounds) (as Tl)	OSHA ID 121	1202	0.1 mg/m ³		960			2000			8		AA or AES	F/CST	225-3-01	90	C/HLD	225-1	102	
Thimet (phorate)	OSHA CSI				480	15		1000	1000		8	15	GC-FPD	ST	226-30-16		38			
Thiobencarb (Organonitrogen Pesticides)	NIOSH 5601				240			1000			4		HPLC-UV	ST	226-58	or	ST	226-30-16	38	
4,4'-Thiobis(6-tert-butyl-m-cresol) (respirable dust)	OSHA CSI		5 mg/m ³		varies			varies			varies		HPLC-UV	F/CST CYC	225-706 225-105	96	C/HLD	225-1	102	
4,4'-Thiobis(6-tert-butyl-m-cresol) (total dust)	OSHA CSI		15 mg/m ³		60			1000			1		HPLC-UV	F/CST	225-706	96	C/HLD	225-1	102	
Thioglycolic acid	OSHA CSI				120			1000			2		HPLC-UV	IMP	225-36-1	67	IT	225-22	67	
Thionyl chloride	OSHA CSI					15		1000			15		IC	IMP	225-36-2	67	IT	225-22	67	
Thiophanate	OSHA CSI				180			1000			3		HPLC-UV	F/CST	225-709	96	C/HLD	225-1	102	
Thiophanate-methyl	OSHA PV2058				240			1000			4		HPLC-UV	F/CST	225-709	96	C/HLD	225-1	102	
Thiophanate-methyl in air	NIOSH 5606				20-480			10-1000			varies		HPLC-UV	ST	226-58		39			
Thiophene	OSHA CSI				48			100			8		GC-FPD	ST	226-01		38			
Thiourea	OSHA PV2059				480			2000			4		HPLC-UV	F/CST	225-706	96	C/HLD	225-1	102	
Thiram	NIOSH 5005		5 mg/m ³		120			1000			2		HPLC-UV	FLT C/HLD	225-17-01 225-1	94	CST	225-2LF	97	
Thorium	OSHA CSI				960			2000			8		N ACT	F/CST	225-3-01	90	C/HLD	225-1	102	
L-Thyroxine	OSHA PV2117				240			1000			4		HPLC-UV	F/CST	225-709	96	C/HLD	225-1	102	
Tin (Elements by Cellulosic Internal Capsule Sampler)	NIOSH 7306		2 mg/m ³		1-2000			1000-4000			Varies		ICP-AES	SC	225-8517	90	C/HLD	225-1	102	
Tin (Elements by ICP Aqua Regia Ashing)	NIOSH 7301		2 mg/m ³		5-1000			1000-4000			varies		ICP-AES	F/CST C/HLD	225-3-01 225-1	or	F/CST	225-803 ¥	93	
Tin (Elements by ICP HNO ₃ Digestion)	NIOSH 7303		2 mg/m ³		1-25000			1000-4000			varies		ICP-AES	F/CST	225-3-01	90	C/HLD	225-1	102	
Tin (Elements by ICP HNO ₃ /HClO ₄ , Ashing)	NIOSH 7300	1455	2 mg/m ³		5-1000			1000-4000			varies		ICP-AES	F/CST	225-3-01	90	C/HLD	225-1	102	
Tin (ICP analysis of metal/metalloid particulates from solder operations)	OSHA ID 206		2 mg/m ³		480			2000			4		ICP-AES	F/CST	225-3-01	90	C/HLD	225-1	102	
Tin (inorganic compounds, except oxides) (as Sn)	OSHA ID 121	1201	2 mg/m ³		960			2000			8		AA or AES	F/CST	225-3-01	90	C/HLD	225-1	102	
Tin (organic compounds) (as Sn) (organotin compounds)	NIOSH 5504		0.1 mg/m ³		480			1000			8		HPLC & AA-GF	ST C/HLD	226-30 225-1	38	F/CST	225-706	96	
Tin (organic compounds, see specific compounds) (as Sn)	OSHA CSI																			
Tin oxide ((Stannous Oxide) as Sn)	OSHA ID 121	1200	0.1 mg/m ³		960			2000			8		AA or AES	F/CST	225-3-01	90	C/HLD	225-1	102	
Titanium (Elements by Cellulosic Internal Capsule Sampler)	NIOSH 7306				Varies			1000-4000			Varies		ICP-AES	SC	225-8517	90	C/HLD	225-1	102	
Titanium (Elements by ICP Aqua Regia Ashing)	NIOSH 7301				5-1000			1000-4000			varies		ICP-AES	F/CST C/HLD	225-3-01 225-1	or	F/CST	225-803 ¥	93	
Titanium (Elements by ICP HNO ₃ Digestion)	NIOSH 7303				0.1-10,000			1000-4000			varies		ICP-AES	F/CST	225-3-01	90	C/HLD	225-1	102	
Titanium (Elements by ICP HNO ₃ /HClO ₄ , Ashing)	NIOSH 7300	1455			5-100			1000-4000			varies		ICP-AES	F/CST	225-3-01	90	C/HLD	225-1	102	
Titanium (see titanium dioxide)	OSHA CSI																			
Titanium dioxide (particulates, respirable)	NIOSH 0600	1038			375			2500			2.5		GR	FLT CYC	225-5-37-P 225-01-02	93 111	C/HLD CST	225-1 225-3LF	102 97	
Titanium dioxide (particulates, total)	NIOSH 0500	1035			120			2000			1		GR	FLT CST	225-5-37-P 225-2LF	93 97	C/HLD	225-1	102	
Titanium dioxide (total dust)	OSHA CSI		15 mg/m ³		960			2000			8		GR	F/CST	225-803	93	C/HLD	225-1	102	
TNT (2,4,6-trinitrotoluene)	OSHA 44		1.5 mg/m ³		60			1000			1		GC-TEA- EAP	ST	226-56		39			
o-Tolidine	OSHA 71	1236			100			1000			100 min		GC-ECD	CF/CST	225-9004	64	C/HLD	225-1	102	
o-Tolidine based dyes	OSHA CSI				480			1000			8		HPLC-UV	FLT C/HLD	225-17A 225-1	94	CST	225-3LF	97	
o-Tolidine dyes (dyes, benzidine)	NIOSH 5013		LFC		480			1000			8		HPLC-UV	FLT C/HLD	225-17A 225-1	94	CST	225-3LF	97	
m-Tolualdehyde	ASTM D 5197				varies			500-1200			5 min-24 hrs		HPLC-UV	ST	226-120 °	or	ST	226-119	40	
o-Tolualdehyde	ASTM D 5197				varies			500-1200			5 min-24 hrs		HPLC-UV	ST	226-120 °	or	ST	226-119	40	
p-Tolualdehyde	ASTM D 5197				varies			500-1200			5 min-24 hrs		HPLC-UV	ST	226-120 °	or	ST	226-119	40	
o-Toluamide	OSHA CSI		5 mg/m ³		240			1000			4		HPLC	F/CST	225-709	96	C/HLD	225-1	102	
Toluene	ASTM D 5466				6			varies			varies		GC-MS	CAN	228 Series		PK	228 Series		
Toluene	EPA TO-17	1689			1 L & 4 L			16.7 ml/min & 66.7 ml/min					TD, GC	ST CPC	226-300 Series 224-26-CPC	42 51	TH	224-26-02	51	
Toluene	OSHA 07		200	300	10	3		20(50)	200		8(3.3)	15	GC-FID	ST	226-01		38			
Toluene	OSHA 111	1748	200	300 (C)	12	0.5		50	50		4	10	GC-FID	ST	226-81A		39	ST	226-01	38
Toluene (Hydrocarbons, Aromatic)	NIOSH 1501		100	150	1-8	1-8		10-200	10-200		varies	varies	GC-FID	ST	226-01		38			
2,4-Toluene diisocyanate	ASTM D 5836	1432			15			1000			15		HPLC-UV or HPLC-FD	CF/CST	225-9002	64	C/HLD	225-1	102	
2,4-Toluene diisocyanate	ASTM D 5932				15			1000			15		HPLC-UV- FD	CF/CST	225-9022	64	C/HLD	225-1	102	

Agency standards for OSHA listings represent the OSHA PELs reported in the 29 CFR 1910.1000 Part 1910, Section 1000.

References and abbreviations are found on pages 212-213.

Sampling Guide

www.skinc.com for updates

T

Chemical Hazard	Agency Reference	Chem F File	SAMPLING ∞								Analytical Method	SKC Collecting Equipment & Page Number				
			Agency Standard		Vol. (liter)		Rate (ml/min)		Time							
			TWA (ppm)	CLG/STEL (ppm)	TWA (Sample Time or Air Volume)	CLG/STEL	TWA (Flow/Sampling Rate)	CLG/STEL	TWA (hrs)	CLG/STEL (min)						
2,4-Toluene diisocyanate	OSHA 42	1458		0.02 (C)	240	15	1000	1000	4	15	HPLC-UV or HPLC-FD	CF/CST C/HLD 225-1	225-9002	or 102	CF/CST 225-9013	64
2,6-Toluene diisocyanate	ASTM D 5836	1432			15		1000		15		HPLC-UV or HPLC-FD	CF/CST	225-9002	64	C/HLD 225-1	102
2,6-Toluene diisocyanate	ASTM D 5832				15		1000		15		HPLC-UV-FD	CF/CST	225-9022	64	C/HLD 225-1	102
2,6-Toluene diisocyanate	OSHA 42	1458			240		1000		4		HPLC-UV or HPLC-FD	CF/CST C/HLD 225-1	225-9002	or 102	CF/CST 225-9013	64
2,4-Toluene diisocyanate (isocyanates)	NIOSH 5521		LFC		480	10	1000	1000	8	10	HPLC-ELCHM & HPLC-UV	IMP	225-36-1	67	IT 225-22	67
2,4-Toluene diisocyanate (isocyanates)	OR-OSHA 1010		0.02	0.005	45	5	1000	1000	45 min	5	HPLC	IMP CF/CST	225-36-1 225-9029	67 64	IT 225-22	67
2,6-Toluene diisocyanate (isocyanates)	NIOSH 5521		LFC		480		1000		8		HPLC-ELCHM & HPLC-UV	IMP	225-36-1	67	IT 225-22	67
2,6-Toluene diisocyanate (isocyanates)	OR-OSHA 1010		0.02	0.005	45	5	1000	1000	45 min	5	HPLC	IMP CF/CST	225-36-1 225-9029	67 64	IT 225-22	67
2,4-Toluene diisocyanate (isocyanates, total)	NIOSH 5525		LFC		1-500		1000-2000		varies		HPLC-UV	FLT SP FLT	225-7 ‡ 225-27 225-702 ‡	96 or 96	CST IOM 225-76A	97 108
2,6-Toluene diisocyanate (isocyanates, total)	NIOSH 5525		LFC		1-500		1000-2000		varies		HPLC-UV	FLT SP FLT	225-7 ‡ 225-27 225-702 ‡	96 or 96	CST IOM 225-76A	97 108
p-Toluene sulfonic acid	NIOSH 5043				960	45	2000	3000	8	15	HPLC-UV	FLT	225-16	96	CST 225-32	102
p-Toluene sulfonic acid	OSHA CSI				120		1000		2		HPLC-UV	IMP	225-36-1	67	IT 225-22	67
Toluene-2,4-diamine	OSHA 65	1237		0.02 (C)	100		1000		100 min		GC-ECD	CF/CST	225-9004	64	C/HLD 225-1	102
2,4-Toluenediamine	NIOSH 5516		LFC		480		1000		8		HPLC-UV	IMP	225-36-1	67	IT 225-22	67
2,4-Toluenediamine	OSHA 65	1237		0.02 (C)	100		1000		100 min		GC-ECD	CF/CST	225-9004	64	C/HLD 225-1	102
2,6-Toluenediamine	NIOSH 5516		LFC		480		1000		8		HPLC-UV	IMP	225-36-1	67	IT 225-22	67
2,6-Toluenediamine	OSHA 65	1237			100		1000		100 min		GC-ECD	CF/CST	225-9004	64	C/HLD 225-1	102
2,6-Toluenediamine	OSHA 65	1237			100		1000		100 min		GC-ECD	CF/CST	225-9004	64	C/HLD 225-1	102
m-Toluidine	OSHA 73	1230			100		1000		100 min		GC-ECD	CF/CST	225-9004	64	C/HLD 225-1	102
o-Toluidine	NIOSH 2017		LFC		24		200		2		GC-FID	CF/CST	225-9004	64	ST 226-15	38
o-Toluidine	OSHA 73	1230	5		100		1000		100 min		GC-ECD	CF/CST	225-9004	64	C/HLD 225-1	102
p-Toluidine	OSHA 73	1230			100		1000		100 min		GC-ECD	CF/CST	225-9004	64	C/HLD 225-1	102
o-Toluidine (Amines, Aromatic)	NIOSH 2002	1057	LFC		48		100		8		GC-FID or GC-NSD	ST	226-10	38		
o-Toluidine based dyes	OSHA CSI				480		1000		8		HPLC-UV	FLT C/HLD	225-17-04 225-1	94 102	CST 225-3LF	97
Torak	OSHA CSI										W	W	225-2401A	140		
Torula species (fungi, molds, spores)	OSHA CSI				120		1000		2		varies	F/CST	225-3-01	90	C/HLD 225-1	102
Torula species (fungi, molds, spores)	OSHA CSI				141.5		28300		5 min		varies	BI	225-9611	120		
Toxaphene (see chlorinated camphene)																
Tremolite (see asbestos fibers)	NIOSH 7400															
Tremolite fibers (see asbestos)	OSHA ID 160															
Triallyl isocyanurate	OSHA CSI				10		20(50)		8(3,3)		GC-NPD	ST	226-01	38		
Triazine pesticides	ASTM D 4861				960		2000		8		GC-ECD	PUF	226-92	44		
Tributyl phosphate	NIOSH 5034		0.2		90		1500		1		GC-FPD	F/CST	225-3-01	90	C/HLD 225-1	102
Tributyl phosphate	OSHA CSI		5 mg/m³		90		1500		1		GC-FPD	F/CST	225-3-01	90	C/HLD 225-1	102
Tributyl phosphorotrithioate	OSHA CSI				480		1000		8		GC-FPD	IMP	225-36-1	67	IT 225-22	67
Tributyl phosphorotrithioate	OSHA CSI				480		1000		8		GC-FID	IMP	225-36-1	67	IT 225-22	67
Tributyltin benzoate (tin, organic compounds (as Sn))	OSHA ID 222SG				200		2000		100 min		AA-GF	F/CST	225-803	93	C/HLD 225-1	102
Tributyltin chloride (organotin compounds as Sn)	NIOSH 5504		0.1 mg/m³		480		1000		8		HPLC & AA-GF	ST C/HLD	226-30 225-1	38 102	F/CST 225-709	96
Tributyltin fluoride (tin, organic compounds (as Sn))	OSHA ID 223SG				200		2000		100 min		AA-GF	F/CST	225-803	93	C/HLD 225-1	102
Tributyltin neodecanoate (see tin, organic compounds)																
Trichlorfon	OSHA CSI				390		1000		6.5		GC-FPD	ST	226-30-16	38		
1,1,2-Trichloro-1,2,2-trifluoroethane	OSHA 113		1000		1		50		20 min		GC-FID	ST	NA SKC			
1,1,2-Trichloro-1,2,2-trifluoroethane (Freon 113)	NIOSH 1020	1061	1000	1250	2.4	0.3	20	20	2	15	GC-FID	ST	226-01	38		
1,1,1-Trichloro-2,2,2-trifluoroethane	OSHA CSI				3		20		2.5		GC-FID	ST	226-01	38		
Trichloroacetic acid	OSHA PV2017				10		200		50		HPLC-UV	ST	226-10	38		

Agency standards for OSHA listings represent the OSHA PELs reported in the 29 CFR 1910.1000 Part 1910, Section 1000.

References and abbreviations are found on pages 212-213.

Chemical Hazard	Agency Reference	Chem F File	SAMPLING ∞								Analytical Method	SKC Collecting Equipment & Page Number							
			Agency Standard		Vol. (liter)		Rate (ml/min)		Time										
			TWA (ppm)	CLG/STEL (ppm)	TWA	CLG/STEL	TWA	CLG/STEL	TWA (hrs)	CLG/STEL (min)									
1,2,3-Trichlorobenzene	ASTM D 4861				240-7200			1000- 5000			4 to 24	GC-ECD	PUF	226-124	44				
1,2,3-Trichlorobenzene	OSHA CSI				12			50			4	GC-ECD	FLT ST	225-17-03 226-30-04	94 38	CST C/HLD	Special order 225-1	102	
1,2,4-Trichlorobenzene	ASTM D 5466				6			varies			varies	GC-MS	CAN	228 Series		PK	228 Series		
1,2,4-Trichlorobenzene	OSHA CSI					5		1000			5	GC-ECD	FLT ST	225-17-03 226-30-04	94 38	CST C/HLD	Special order 225-1	102	
1,2,4-Trichlorobenzene (polychlorobenzenes)	NIOSH 5517			5	12	3		25	200		8	15	GC-ECD	FLT ST	225-17-03 226-30-04	94 38	CST C/HLD	Special order 225-1	102
1,1,2-Trichloroethane	ASTM D 5466				6			varies			varies	GC-MS	CAN	228 Series		PK	228 Series		
1,1,2-Trichloroethane	EPA TO-17	1689			1 L & 4 L			16.7 ml/min & 66.7 ml/min				TD, GC	ST CPC	226-300 Series 224-26-CPC	42 51	TH	224-26-02	51	
1,1,2-Trichloroethane	OSHA 11	1071	10		10			200			1	GC-FID	ST	226-01	38				
1,1,2-Trichloroethane (hydrocarbons, halogenated)	NIOSH 1003		10 (skin)		10			10-200			varies	GC-FID	ST	226-01	38				
1,1,1-Trichloroethane (methyl chloroform)	EPA TO-17	1689			1 L & 4 L			16.7 ml/min & 66.7 ml/min				TD, GC	ST CPC	226-300 Series 224-26-CPC	42 51	TH	224-26-02	51	
1,1,1-Trichloroethane (methyl chloroform) (hydrocarbons, halogenated)	NIOSH 1003			350		3		10-200			varies	GC-FID	ST	226-01	38				
Trichloroethylene	ASTM D 5466				6			varies			varies	GC-MS	CAN	228 Series		PK	228 Series		
Trichloroethylene	EPA TO-17	1689			1 L & 4 L			16.7 ml/min & 66.7 ml/min				TD, GC	ST CPC	226-300 Series 224-26-CPC	42 51	TH	224-26-02	51	
Trichloroethylene	NIOSH 1022		25	2 (1 hr)	10	2		20(50)	200		8(3.3)	10	GC-FID	ST	226-01	38			
Trichloroethylene	OSHA 07	1184	100	200 (C)	10	3		20(50)	200		8(3.3)	15	GC-FID	ST	226-01	38			
Trichloroethylene	OSHA 1001	1747	100	200 (C)	12	0.75		50	50		4	5	GC-FID	ST	226-01	38			
Trichloroethylene	OSHA 1001	1747	100	200 (C)				14.24			8	5	GC-FID	PS	575-002	75			
Trichloroethylene (hydrocarbons, halogenated)	NIOSH 1003				10			10-200			varies		GC-FID	ST	226-01	38			
Trichloroethylene by portable GC	NIOSH 3701	1030	25	2 (1 hr)	varies	varies		20-50	varies		varies	varies	P GC-PID	SB	232 Series	55			
Trichlorofluoromethane (fluorotrichloromethane)	NIOSH 1006			1000		5		20			240		GC-FID	ST	226-09	38			
Trichloronaphthalene	OSHA CSI		5 mg/m ³		90			1000			1.5		GC-ECD	ST	226-30-16	38			
Trichloronitromethane	NON 51		0.1		144			100			24		GC-MSD	ST	226-175	41			
2,4,5-Trichlorophenol	ASTM D 4861				240-7200			1000- 5000			4 to 24		GC-ECD	PUF	226-92	44			
2,4,5-Trichlorophenoxyacetic acid (see 2,4,5-T)																			
1,2,3-Trichloropropane	OSHA 07	1185	50		10			20(50)			8(3.3)		GC-FID	ST	226-01	38			
1,2,3-Trichloropropane (hydrocarbons, halogenated)	NIOSH 1003		10 (skin)		0.6-60			10-200			varies		GC-FID	ST	226-01	38			
2,3,6-Trichlorotoluene	OSHA CSI				10			20(50)			8(3.3)		GC-FID	ST	226-01	38			
Trichoderma species (fungi, molds, spores)	OSHA CSI				120			1000			2		varies	F/CST	225-3-01	90	C/HLD	225-1	102
Trichoderma species (fungi, molds, spores)	OSHA CSI				141.5			28300			5 min		varies	BI	225-9611	120			
Tricyclohexylin hydroxide (organotin compounds as Sn)	NIOSH 5504		0.1 mg/m ³		480			1000			8		HPLC & AA-GF	ST C/HLD	226-30 225-1	38	F/CST	225-709	96
Tridymite (see Silica, respirable crystalline)	OSHA ID 142																		
Tridymite (silica, crystalline (respirable)) by XRD	NIOSH 7500	1370	0.05 mg/m ³		400-1000			2500			varies		XRD	F/CST C/HLD	225-803 225-1	93 102	CYC	225-01-02	111
Tridymite (Silica, crystalline by IR)	NIOSH 7602		0.05 mg/m ³		400-800			2500			varies		IR	F/CST CYC	225-803 225-01-02	93 111	C/HLD	225-1	102
Triethanolamine (TEA)	OSHA PV2141				120			1000			2		GC-FID	F/CST	225-709	96	C/HLD	225-1	102
Triethanolamine (TEA) (Aminoethanol Compounds II)	NIOSH 3509				240			1000			4		IC	IMP	225-36-1	67	IT	225-22	67
Triethylamine	OSHA PV2060		25		5	3		100	200		50 min	15	GC-FID	ST	226-98	40			
Triethylene glycol	NIOSH 5523				60			1000			1		GC-FID	ST	226-57	39			
Triethylenetetramine (TETA)	OSHA 60	1286			10			100			100 min		HPLC-UV	ST	226-30-18	38			
Trifluorobromomethane	NIOSH 1017		1000		1			20			50 min		GC-FID	ST	226-01	38	ST	226-09	38
2,2,2-Trifluoroethanol	OSHA CSI				5			20			4		GC-FID	ST	226-01	38			
Trifluoromonobromomethane	OSHA 07		1000		1			20			50 min		GC-FID	ST	226-01	38	ST	226-09	38
Trifluoromonobromomethane (trifluorobromomethane)	NIOSH 1017		1000		1			20			50 min		GC-FID	ST	226-01	38	ST	226-09	38
Trifluralin	ASTM D 4861				240-7200			1000- 5000			4 to 24		GC-ECD	PUF	226-92	44			
Trifluralin	OSHA CSI				48			100			8		HPLC-UV	ST	226-56	39			
1,3,5-Triglycidyl isocyanurate	OSHA PV2055				60			1000			1		GC-ECD	CF/CST	225-9027	64	C/HLD	225-1	102
Trimellitic anhydride (TMA)	NIOSH 5036		0.005 (10 hr)		960			2000			8		GC-FID	F/CST	225-802	93	C/HLD	225-1	102
Trimellitic anhydride (TMA)	OSHA 98				480			2000			4		HPLC-UV	CF/CST	225-9010 ††	64	C/HLD	225-1	102
2,2,4-Trimethyl-1,3-pentanediol diisobutyrate	OSHA PV2002				10			100			100 min		GC-FID	ST	226-110	40			
Trimethylamine	OSHA CSI				10	1.5		100	100		100 min	15	GC-NPD	ST	226-98	40			
1,2,3-Trimethylbenzene	OSHA PV2091				10			100			100 min		GC-FID	ST	226-01	38			
1,2,4-Trimethylbenzene	ASTM D 5466				6			varies			varies		GC-MS	CAN	228 Series		PK	228 Series	

Agency standards for OSHA listings represent the OSHA PELs reported in the 29 CFR 1910.1000 Part 1910, Section 1000.

References and abbreviations are found on pages 212-213.

Sampling Guide

www.skinc.com for updates

T

Chemical Hazard	Agency Reference	Chem F File	SAMPLING ∞								Analytical Method	SKC Collecting Equipment & Page Number					
			Agency Standard		Vol. (liter)		Rate (ml/min)		Time								
			TWA (ppm)	CLG/STEL (ppm)	TWA Sample Time or Air Volume	CLG/STEL	TWA Flow/Sampling Rate	CLG/STEL	TWA (hrs)	CLG/STEL (min)							
1,2,4-Trimethylbenzene	EPA TO-17	1689			1 L & 4 L		16.7 ml/min & 66.7 ml/min				TD, GC	ST CPC	226-300 Series 224-26-CPC	42 51	TH	224-26-02	51
1,2,4-Trimethylbenzene	OSHA PV2091				10		100		100 min		GC-FID	ST	226-01				38
1,3,5-Trimethylbenzene	EPA TO-17	1689			1 L & 4 L		16.7 ml/min & 66.7 ml/min				TD, GC	ST CPC	226-300 Series 224-26-CPC	42 51	TH	224-26-02	51
1,3,5-Trimethylbenzene (mesitylene)	ASTM D 5466				6		varies		varies		GC-MS	CAN	228 Series		PK		228 Series
1,3,5-Trimethylbenzene (mesitylene)	OSHA PV2091				10		100		100 min		GC-FID	ST	226-01				38
3,5,5-Trimethylcyclohex-2-enone (isophorone)	EPA TO-17	1689			1 L & 4 L		16.7 ml/min & 66.7 ml/min				TD, GC	ST CPC	226-300 Series 224-26-CPC	42 51	TH	224-26-02	51
Trimethylethane trinitrate	OSHA CSI				15		1000		15 min		HPLC-UV	ST	226-35-03				39
Trimethylolpropane triacrylate	OSHA CSI				10		20(50)		8(3.3)		HPLC-UV	ST	226-95				40
Trimethyltin dichloride	NIOSH 5526		0.1 mg/m ³		60	60	250	1000	4	60	GC-FPD	ST	226-30-16				38
2,4,7-Trinitro-9-fluorenone	OSHA CSI				480		1000		8		HPLC-UV	FLT C/HLD	225-17A 225-1	94	CST	225-3LF	97
2,4,7-Trinitrofluorene-9-one	NIOSH 5018				480		3000		2.7		HPLC-UV	FLT C/HLD	225-17-04 225-1	94	CST	225-3LF	97
2,4,6-Trinitrotoluene (TNT)	OSHA 44		1.5 mg/m ³		60		1000		1		GC-TEA-EAP	ST	226-56				39
Triorthocresyl phosphate	NIOSH 5037		0.1 mg/m ³		90		1000		1.5		GC-FPD	F/CST	225-3-01	90	C/HLD	225-1	102
Triphenyl phosphate	NIOSH 5038		3 mg/m ³		240		1000		4		GC-FPD	F/CST	225-3-01	90	C/HLD	225-1	102
Triphenyl tin chloride (as Sn)	NIOSH 5527		0.1 mg/m ³ (skin)		100-2000		1000-4000		varies		HPLC & ICP-AES	FLT	225-5-37-P	93	C/HLD	225-1	102
Triphenylamine	OSHA CSI				240		1000		4		HPLC-UV	IMP	225-36-2	67	IT	225-22	67
Triphenyltin fluoride (tin, organic compounds (as Sn))	OSHA CSI		0.1 mg/m ³		960		2000		8		AA-GF	F/CST	225-709	96	C/HLD	225-1	102
Triphenyltin hydroxide (tin, organic compounds (as Sn))	OSHA ID 225SG		0.1 mg/m ³		200		2000		100 min		AA-GF	F/CST	225-709	96	C/HLD	225-1	102
Tripoli (see Silica, respirable crystalline)	OSHA ID 142																
Tripropylene glycol diacrylate	OSHA CSI				10		20(50)		8(3.3)		HPLC-UV	ST	226-95				40
Tripropylene glycol diacrylate (TPGDA)	NON 39				480		1000		8		GC-FID	ST	226-56				39
Trydimite (silica, crystalline by VAS)	NIOSH 7601	1041	0.05 mg/m ³		400-800		2500		varies		VAS	F/CST CYC	225-803 225-01-02	93	C/HLD	225-1	102
Trypsin	OSHA CSI				480		2000		4		IRA	F/CST	225-1713	94	C/HLD	225-1	102
Tuberculosis (mycobacterium tuberculosis), airborne	NIOSH 0900				1920		4000		8		PCR	FLT CST	225-2705 225-3LF	94	SP	225-27	103
Tungsten & compounds (insoluble) (as W)	OSHA ID 213				480	30	2000	2000	4	15	ICP	F/CST	225-3-01	90	C/HLD	225-1	102
Tungsten & compounds (soluble) (as W)	OSHA ID 213				480	30	2000	2000	4	15	ICP	F/CST	225-3-01	90	C/HLD	225-1	102
Tungsten (Elements by Cellulosic Internal Capsule Sampler)	NIOSH 7306		5 mg/m ³ 10 mg/m ³		Varies		1000-4000		Varies		ICP-AES	SC	225-8517	90	C/HLD	225-1	102
Tungsten (Elements by ICP Aqua Regia Ashing)	NIOSH 7301		5 mg/m ³ 10 mg/m ³		50-1000	50-1000	1000-4000	1000-4000	varies	varies	ICP-AES	F/CST C/HLD	225-3-01 225-1	or	F/CST	225-803	93
Tungsten (Elements by ICP HNO ₃ /HClO ₄ Ashing)	NIOSH 7300	1455	5 mg/m ³ 10 mg/m ³		5-1000	5-1000	1000-4000	1000-4000	varies	varies	ICP-AES	F/CST	225-3-01	90	C/HLD	225-1	102
Tungsten insoluble	NIOSH 7074		5 mg/m ³ 10 mg/m ³		480		1000		8		AA-F	F/CST	225-3-01	90	C/HLD	225-1	102
Tungsten soluble	NIOSH 7074		1 mg/m ³ 3 mg/m ³		480		1000		8		AA-F	F/CST	225-3-01	90	C/HLD	225-1	102
Turpentine	NIOSH 1551		100		10		20(50)		8(3.3)		GC-FID	ST	226-01				38
n-Undecane	EPA TO-17	1689			1 L & 4 L		16.7 ml/min & 66.7 ml/min				TD, GC	ST CPC	226-300 Series 224-26-CPC	42 51	TH	224-26-02	51
n-Undecane (hydrocarbons, BP 36 to 216 C)	NIOSH 1500		2		2		10 - 50		varies		GC-FID	ST	226-01				38
Uranium (as U) soluble compounds	OSHA CSI		0.05 mg/m ³		960		2000		8		DPCSP	F/CST	225-803	93	C/HLD	225-1	102
Uranium (insoluble compounds)	OSHA CSI		0.25 mg/m ³		960	30	2000	2000	8	15	ICP	F/CST	225-3-01	90	C/HLD	225-1	102
Uranium (soluble compounds)	OSHA ID 170SG		0.05 mg/m ³		240		2000		2		POL	F/CST	225-803	93	C/HLD	225-1	102
Urea pesticides	ASTM D 4861				240-7200		1000-5000		4 to 24		GC-ECD	PUF	226-92				44
n-Valeraldehyde	ASTM D 5197				varies		500-1200		5 min to 24 hrs		HPLC-UV	ST	226-120 ^o	or	ST	226-119	40
n-Valeraldehyde	NIOSH 2536		50		10		20		8		GC-FID	ST	226-118				40
n-Valeraldehyde	OSHA 85				3		50		1		HPLC-UV	CF/CST	225-9020	64	C/HLD	225-1	102
n-Valeraldehyde (Aldehydes, Screening)	NIOSH 2539		50		5		20		4		GC-FID & GC-MS	ST	226-118				40
Vanadium (Elements by ICP HNO ₃ Digestion))	NIOSH 7303		0.05 mg/m ³		2.5-500,000		1000-4000		varies		ICP-AES	F/CST	225-3-01	90	C/HLD	225-1	102
Vanadium (Elements by ICP HNO ₃ /HClO ₄ Ashing)	NIOSH 7300	1455	0.05 mg/m ³		5-2000		1000-4000		varies		ICP-AES	F/CST	225-3-01	90	C/HLD	225-1	102
Vanadium (Elements by Cellulosic Internal Capsule Sampler)	NIOSH 7306		0.05 mg/m ³ C (as pentoxide)		Varies		1000-4000		Varies		ICP-AES	SC	225-8517	90	C/HLD	225-1	102
Vanadium (Elements by ICP Aqua Regia Ashing)	NIOSH 7301		0.05 mg/m ³		5-2000		1000-4000		varies		ICP-AES	F/CST C/HLD	225-3-01 225-1	or	F/CST	225-803	93
Vanadium (Elements on Wipes)	NIOSH 9102				wipe						ICP-AES	W TMP	225-2414 225-2415	140	TMP	225-2403	or 140

Agency standards for OSHA listings represent the OSHA PELs reported in the 29 CFR 1910.1000 Part 1910, Section 1000.

References and abbreviations are found on pages 212-213.

Chemical Hazard	Agency Reference	Chem F File	SAMPLING ∞								Analytical Method	SKC Collecting Equipment & Page Number			
			Agency Standard		Vol. (liter)		Rate (ml/min)		Time						
			TWA (ppm)	CLG/STEL (ppm)	TWA	CLG/STEL	TWA	CLG/STEL	TWA (hrs)	CLG/STEL (min)					
Vanadium fume (as V ₂ O ₅)	OSHA ID 125G		0.05 mg/m ³	0.1	480	20	2000	1000	4	20	ICP-AES	F/CST 225-3-01 F/CST 225-803 C/HLD 225-1	or or 102	F/CST 225-3100 or F/CST 225-8215	or 93
Vanadium oxides	NIOSH 7504		0.05 mg/m ³ (15 min)		600		2600		4		XRD	F/CST 225-803 CYC 225-01-02	93 111	C/HLD 225-1	102
Vanadium pentoxide (V ₂ O ₅) (see vanadium oxides)	NIOSH 7504														
Vanadium pentoxide (V ₂ O ₅) (confirmation of)	OSHA ID 185		0.05 mg/m ³	0.05 mg/m ³	varies		varies		varies		XRD	F/CST 225-803 C/HLD 225-1	93 102	CYC 225-105	110
Vanadium respirable dust (as V ₂ O ₅)	OSHA ID 125G		0.5 mg/m ³				varies			varies	ICP-AES	F/CST 225-3-01 C/HLD 225-1	90 102	CYC 225-105	110
Vanadium trioxide (see vanadium oxides)	NIOSH 7504														
Vegetable oil mist (see dust, respirable & total nuisance)	OSHA CSI														
Vermiculite (see dust, total & respirable nuisance)															
Verticillium species (fungi, molds, spores)	OSHA CSI				120		1000		2		varies	F/CST 225-3-01	90	C/HLD 225-1	102
Verticillium species (fungi, molds, spores)	OSHA CSI				141.5		28300		5 min		varies	BI 225-9611	120		
Vinyl acetate	NON 21				24		50		8		GC	ST 226-68	39		
Vinyl acetate	OSHA 51				24	3	100	200	4	15	GC-FID	ST NA SKC			
Vinyl bromide	NIOSH 1009		LFC		10		20(50)		8(3.3)		GC-FID	ST 226-09	38		
Vinyl bromide	OSHA 08	1074			5		20		4		GC-FID	ST 226-01	38		
Vinyl chloride	ASTM D 4766	1434			24		100 or 50		4 or 8		GC-FID	ST 226-16	38		
Vinyl chloride	ASTM D 5466				6		varies		varies		GC-MS	CAN 228 Series	PK	228 Series	
Vinyl chloride	NIOSH 1007		LFC		5		50		1.6		GC-FID	ST 226-01	38		
Vinyl cyclohexene dioxide	OSHA PV2083				10		20(50)		8(3.3)		GC-FID	ST 226-30	38		
Vinyl toluene	OSHA 07	100			10		20(50)		8(3.3)		GC-FID	ST 226-01	38		
Vinyl toluene (methyl styrene)	EPA TO-17	1689			1 L & 4 L		16.7 ml/min & 66.7 ml/min				TD, GC	ST 226-300 Series CPC 224-26-CPC	42 51	TH 224-26-02	51
N-Vinyl-2-pyrrolidinone	OSHA PV2106				10		100		100 min		GC-FID	ST 226-01	38		
Vinylidene chloride	ASTM D 5466				6		varies		varies		GC-MS	CAN 228 Series	PK	228 Series	
Vinylidene chloride	NIOSH 1015		LFC		5		20		4		GC-FID	ST 226-01	38		
Vinylidene chloride	OSHA 19				3	3	200	200	15 min	15	GC-FID	ST 226-01	38		
Viruses (in air)	NON 48				62.5-375		12500 +		5-30		varies	BS 225-9595	122	VT 225-9598A	122
VM&P naphtha	OSHA 48				3	3	20	200	2.5	15	GC-FID	ST 226-01	38		
VM&P naphtha (naphthas)	NIOSH 1550		350 mg/m ³	1800 mg/m ³	10	3	20(50)	200	8(3.3)	15	GC-FID	ST 226-01	38		
Volatile organic compounds (screening)	NIOSH 2549				5		20		4		GC-MS	ST 226-330	42		
Volatile organic compounds (VOCs) (canister)	EPA TO-14A	1676			varies		varies		varies		GC-MS	CAN 228 Series	PK	228 Series	
Volatile organic compounds (VOCs) (canister)	EPA TO-15	1676			varies		varies		varies		GC-MS	CAN 228 Series	PK	228 Series	
Volatile organic compounds (VOCs) (sample bag)	EPA 0040	1665					250-1000 ml/min		1-2 hrs		GC-MS	VAC 231-939 SB 236-004 SB 236-001	or or or	VAC 231-940 SB 232-939 SB 232-01	with or or
Volatile organic compounds (VOCs) (thermal desorption tube)	EPA TO-17	1689			1 L & 4 L		16.7 ml/min & 66.7 ml/min				TD, GC	ST 226-300 Series CPC 224-26-CPC	42 51	TH 224-26-02	51
VOST (volatile organic sampling train)	EPA 0031				20 min		1 L/min		20 min		TD, GC-MS	ST 226-134 £	41	ST Special Order	
Vydate (oxamyl)	OSHA CSI				60		1000		1		HPLC	ST 226-30-16	38		
Wallemia species (fungi, molds, spores)	OSHA CSI				120		1000		2		varies	F/CST 225-3-01	90	C/HLD 225-1	102
Wallemia species (fungi, molds, spores)	OSHA CSI				141.5		28300		5 min		varies	BI 225-9611	120		
Warfarin	NIOSH 5002		0.1 mg/m ³		360		1500		4		HPLC-UV	FLT 225-17-01 C/HLD 225-1	94 102	CST 225-2LF	97
Welding fumes (total particulate)	OSHA ID 125G				480		2000		4		ICP-AES	F/CST 225-3-01 F/CST 225-803 C/HLD 225-1	or or 102	F/CST 225-3100 or F/CST 225-8215	or 93
Wemicide CW 104	OSHA CSI				480		1000		8		HPLC-UV	ST 226-30-16	38		
Wollastonite (see dust, total and respirable nuisance)	OSHA CSI														
Wood alcohol (methanol)	NIOSH 2000		200	250	5	3	20	200	4	15	GC-FID	ST 226-51	39		
Wood dust (except western red cedar)	OSHA CSI				960	30	2000	2000	8	30	GR	F/CST 225-803	93	C/HLD 225-1	102
Wood dust (western red cedar)	OSHA CSI		2.5 mg/m ³		960		2000		8		GR	F/CST 225-803	93	C/HLD 225-1	102
Wood dust, hardwood	OSHA CSI		15 mg/m ³		960		2000		8		GR	F/CST 225-803	93	C/HLD 225-1	102
Wood dust, softwood	OSHA CSI		15 mg/m ³		960		2000		8		GR	F/CST 225-803	93	C/HLD 225-1	102
Wood spirit (methanol)	NIOSH 2000		200	250	5	3	20	200	4	15	GC-FID	ST 226-51	39		
m-Xylene	ASTM D 5466				6		varies		varies		GC-MS	CAN 228 Series	PK	228 Series	
m-Xylene	EPA TO-17	1689			1 L & 4 L		16.7 ml/min & 66.7 ml/min				TD, GC	ST 226-300 Series CPC 224-26-CPC	42 51	TH 224-26-02	51
m-Xylene	OSHA 1002	1746	100				13.82		8		GC-FID	PS 575-002	75		
o-Xylene	ASTM D 5466				6		varies		varies		GC-MS	CAN 228 Series	PK	228 Series	

Agency standards for OSHA listings represent the OSHA PELs reported in the 29 CFR 1910.1000 Part 1910, Section 1000.

References and abbreviations are found on pages 212-213.

Sampling Guide

www.skinc.com for updates

X

Chemical Hazard	Agency Reference	Chem F File	SAMPLING ∞								Analytical Method	SKC Collecting Equipment & Page Number						
			Agency Standard		Vol. (liter)		Rate (ml/min)		Time									
			TWA (ppm)	CLG/STEL (ppm)	TWA (Sample Time or Air Volume)	CLG/STEL	TWA (Flow/Sampling Rate)	CLG/STEL	TWA (hrs)	CLG/STEL (min)								
o-Xylene	EPA TO-17	1689			1 L & 4 L		16.7 ml/min & 66.7 ml/min				TD, GC	ST CPC	226-300 Series 224-26-CPC	42 51	TH	224-26-02	51	
o-Xylene	OSHA 1002	1746	100				14.24		8		GC-FID	PS	575-002		75			
p-Xylene	ASTM D 5466				6		varies		varies		GC-MS	CAN	228 Series		PK	228 Series		
p-Xylene	EPA TO-17	1689			1 L & 4 L		16.7 ml/min & 66.7 ml/min				TD, GC	ST CPC	226-300 Series 224-26-CPC	42 51	TH	224-26-02	51	
p-Xylene	OSHA 1002	1746	100				13.94		8		GC-FID	PS	575-002		75			
m-Xylene (Hydrocarbons, Aromatic)	NIOSH 1501		100		2-23		10-200		varies		GC-FID	ST	226-01		38			
o-Xylene (Hydrocarbons, Aromatic)	NIOSH 1501		100	150	2-23	2-23	10-200	10-200	varies	varies	GC-FID	ST	226-01		38			
p-Xylene (Hydrocarbons, Aromatic)	NIOSH 1501		100		2-23		10-200		varies		GC-FID	ST	226-01		38			
Xylene (o-, m-, & p-isomers)	OSHA 07	1186	100		10	3	20(50)	200	8(3.3)	15	GC-FID	ST	226-01		38			
Xylene (o-, m-, & p-isomers)	OSHA 1002	1746	100		12		50		4		GC-FID	ST	226-01		38			
m-Xylenediamine (mXDA)	OSHA 105	1405				15		1000		15	HPLC-UV	CF/CST	225-9004	64	C/HLD	225-1	102	
p-Xylenediamine (pXDA)	OSHA 105	1405				15		1000		15	HPLC-UV	CF/CST	225-9004	64	C/HLD	225-1	102	
Xylidine	OSHA CSI		5		24		50		8		GC-FID	ST	226-10		38			
2,4-Xylidine (Amines, Aromatic)	NIOSH 2002	1056	2		10		20(50)		8(3.3)		GC-FID or GC-NSD	ST	226-10		38			
Yeast (fungi, molds, spores)	OSHA CSI				120		1000		2		varies	F/CST	225-3-01	90	C/HLD	225-1	102	
Yeast (fungi, molds, spores)	OSHA CSI				141.5		28300		5 min		varies	BI	225-9611		120			
Yttrium	OSHA ID 121		1 mg/m ³		960		2000		8		AA or AES	F/CST	225-3-01	90	C/HLD	225-1	102	
Yttrium (Elements by ICP HNO ₃ Digestion)	NIOSH 7303				0.1-50,000		1000-4000		varies		ICP-AES	F/CST	225-3-01	90	C/HLD	225-1	102	
Yttrium (Elements by Cellulosic Internal Capsule Sampler)	NIOSH 7306		1 mg/m ³		1-2000		1000-4000		Varies		ICP-AES	SC	225-8517	90	C/HLD	225-1	102	
Yttrium (Elements by ICP Aqua Regia Ashing)	NIOSH 7301				5-1000		1000-4000		varies		ICP-AES	F/CST C/HLD	225-3-01 225-1	or 102	F/CST	225-803	¥ 93	
Yttrium (Elements by ICP HNO ₃ /HClO ₄ Ashing)	NIOSH 7300	1455			5-1000		1000-4000		varies		ICP-AES	F/CST	225-3-01	90	C/HLD	225-1	102	
Yttrium (Elements on Wipes)	NIOSH 9102				wipe						ICP-AES	W TMP	225-2414 225-2415	140 140	TMP	225-2403	or	
Zectran	OSHA CSI										W	W	225-2401A		140			
Zinc	OSHA ID 121	1204			960		2000		8		AA or AES	F/CST	225-3-01	90	C/HLD	225-1	102	
Zinc	OSHA ID 125G				480		2000		4		ICP-AES	F/CST F/CST C/HLD	225-3-01 225-803 225-1	or or 102	F/CST F/CST 225-3100 225-8215	or 93		
Zinc & compounds (as Zn)	NIOSH 7030		5 mg/m ³ (ZnO)	15 mg/m ³ (ZnO)	240	30	1000	2000	4	15	AA-F	F/CST	225-3-01	90	C/HLD	225-1	102	
Zinc (Elements by Cellulosic Internal Capsule Sampler)	NIOSH 7306		5 mg/m ³	15 mg/m ³ C (dust) 10 mg/m ³ (fume)	Varies		1000-4000		Varies		ICP-AES	SC	225-8517	90	C/HLD	225-1	102	
Zinc (Elements by ICP Aqua Regia Ashing)	NIOSH 7301				5-200		1000-4000		varies		ICP-AES	F/CST C/HLD	225-3-01 225-1	or 102	F/CST	225-803	¥ 93	
Zinc (Elements by ICP HNO ₃ Digestion)	NIOSH 7303		5 mg/m ³ (ZnO)	15 mg/m ³ (ZnO)	0.5-10,000	0.5-10,000	1000-4000	1000-4000	varies	varies	ICP-AES	F/CST	225-3-01	90	C/HLD	225-1	102	
Zinc (Elements by ICP HNO ₃ /HClO ₄ Ashing)	NIOSH 7300	1455	5 mg/m ³ (ZnO)	10 mg/m ³ (ZnO)	5-200	5-200	1000-4000	1000-4000	varies	varies	ICP-AES	F/CST	225-3-01	90	C/HLD	225-1	102	
Zinc (Elements on Wipes)	NIOSH 9102				wipe						ICP-AES	W TMP	225-2414 225-2415	140 140	TMP	225-2403	or	
Zinc bromide (see dust, total and nuisance)																		
Zinc chloride fume	OSHA ID 121	1207	1 mg/m ³		960	30	2000	2000	8	15	AA or AES	F/CST	225-3-01	90	C/HLD	225-1	102	
Zinc chloride fume	OSHA ID 125G		1 mg/m ³		480	30	2000	2000	4	15	ICP-AES	F/CST F/CST C/HLD	225-3-01 225-803 225-1	or or 102	F/CST F/CST 225-3100 225-8215	or 93		
Zinc chromate (CR(VI))	OSHA ID 215 (V2)	1439	0.005 mg/m ³		960		2000		8		IC-UV	F/CST	225-802 Ω	93	C/HLD	225-1	102	
Zinc chromates (as CrO ₃)	OSHA ID 215 (V2)	1439	0.005 mg/m ³		960		2000			15	IC-UV	F/CST	225-802 Ω	93	C/HLD	225-1	102	
Zinc dibutyldithiocarbamate	OSHA PV2065				180		1000		3		HPLC-UV	ST	226-30-16		38			
Zinc oxide	NIOSH 7502		5 mg/m ³	15 mg/m ³ (15 min)	240	30	1000	2000	4	15	XRD	FLT	225-2705	93	CST	225-3-23	97	
Zinc oxide (Elements by ICP HNO ₃ Digestion)	NIOSH 7303		5 mg/m ³	15 mg/m ³	0.5-10,000	0.5-10,000	1000-4000	1000-4000	varies	varies	ICP-AES	F/CST	225-3-01	90	C/HLD	225-1	102	
Zinc oxide (particulates, respirable)	NIOSH 0600	1038			375		2500		2.5		GR	FLT CYC	225-5-37-P 225-01-02	93 111	C/HLD CST	225-1 225-3LF	102 97	
Zinc oxide (particulates, total)	NIOSH 0500	1035			120		2000		1		GR	FLT CST	225-5-37-P 225-2LF	93 97	C/HLD	225-1	102	

Agency standards for OSHA listings represent the OSHA PELs reported in the 29 CFR 1910.1000 Part 1910, Section 1000.

References and abbreviations are found on pages 212-213.

Chemical Hazard	Agency Reference	Chem F File	SAMPLING ∞								Analytical Method	SKC Collecting Equipment & Page Number				
			Agency Standard		Vol. (liter)		Rate (ml/min)		Time							
			TWA (ppm)	CLG/STEL (ppm)	TWA (Sample Time or Air Volume)	CLG/STEL	TWA (Flow/Sampling Rate)	CLG/STEL	TWA (hrs)	CLG/STEL (min)						
Zinc oxide dust (see dust, total & respirable)	OSHA CSI															
Zinc oxide fume	OSHA ID 121		5 mg/m ³	960	30	2000	2000	8	15	AA or AES	FLT CST	225-5-37-P 225-2LF	93 97	C/HLD	225-1	102
Zinc oxide fume	OSHA ID 125G		5 mg/m ³	480	30	2000	2000	4	15	ICP-AES	F/CST F/CST C/HLD	225-3-01 225-803 225-1	or or	F/CST F/CST	225-3100 225-8215	or 93
Zinc oxide fume	OSHA ID 143		5 mg/m ³	960	30	2000	2000	8	15	XRD	FLT CST	225-5-37-P 225-2LF	93 97	C/HLD	225-1	102
Zinc oxide fume (ICP analysis of metal/metalloid particulates from solder operations)	OSHA ID 206		5 mg/m ³	480		2000		4		ICP-AES	F/CST	225-3-01	90	C/HLD	225-1	102
Zinc stearate (particulates, respirable)	NIOSH 0600	1038		375		2500		2.5		GR	FLT CYC	225-5-37-P 225-01-02	93 111	C/HLD CST	225-1 225-3LF	102 97
Zinc stearate (particulates, total)	NIOSH 0500	1035		120		2000		1		GR	FLT CST	225-5-37-P 225-2LF	93 97	C/HLD	225-1	102
Zinc stearate (respirable dust)	OSHA CSI		5 mg/m ³	912		1900		8		GR	F/CST	225-803	93	C/HLD	225-1	102
Zinc stearate (total dust)	OSHA ID 121		15 mg/m ³	960		2000		8		AA or AES	F/CST	225-3-01	90	C/HLD	225-1	102
Zinc stearate (total dust)	OSHA ID 125G		15 mg/m ³	480		2000		4		ICP-AES	F/CST F/CST C/HLD	225-3-01 225-803 225-1	or or	F/CST F/CST	225-3100 225-8215	or 93
Zineb	OSHA 107			500		2000		250 min		HPLC-UV	F/CST	225-3-01	90	C/HLD	225-1	102
Ziram	OSHA PV2073			120		1000		2		HPLC-UV	ST	226-30-16	38			
Zirconium (Elements by Cellulosic Internal Capsule Sampler)	NIOSH 7306		5 mg/m ³ 10 mg/m ³	1-1000		1000-4000		Varies		ICP-AES	SC	225-8517	90	C/HLD	225-1	102
Zirconium (Elements by ICP Aqua Regia Ashing)	NIOSH 7301		5 mg/m ³ 10 mg/m ³	5-200 5-200		1000-4000 1000-4000		varies varies		ICP-AES	F/CST C/HLD	225-3-01 225-1	or 102	F/CST	225-803	¥ 93
Zirconium (Elements by ICP HNO ₃ /HClO ₄ Ashing)	NIOSH 7300	1455	5 mg/m ³ 10 mg/m ³	5-200 5-200		1000-4000 1000-4000		varies varies		ICP-AES	F/CST	225-3-01	90	C/HLD	225-1	102
Zirconium (Elements on Wipes)	NIOSH 9102			wipe						ICP-AES	W TMP	225-2414 225-2415	140 140	TMP	225-2403	or
Zirconium compounds (as Zr)	OSHA ID 121		5 mg/m ³	960	30	2000	2000	8	15	AA or AES	F/CST	225-803	93	C/HLD	225-1	102

Symbols and Notes

∞ The sampling parameters shown are suggestions based on the ranges of volume, flow, and time specified in the methods. It is the responsibility of the analyst performing the sampling and analysis to adjust parameters so that the required detection limits can be obtained. It is the responsibility of the user to research published methods to determine validation level and suitability for unique applications.

C Ceiling Value

CSI OSHA Chemical Sampling Information

EL Excursion Limit

LFC NIOSH standard: Lowest Feasible Concentration

LOQ Limit of Quantitation

NA SKC Not available from SKC

NON Non-agency reference

NVM No validated method

OEL U.S. Army Occupational Exposure Limit

OR-OSHA Oregon OSHA method and target concentrations

PV Provisional Method

Special

order Because of limited shelf-life, certain sampling media are available only as special order items.

** Optional, use filter if particulates are present

‡ Filter or tube must be chemically treated before sampling.

♣ Modified procedure or sampler

◇ Other collection liquids may be more suited to target microorganisms.

¥ This method does not digest PVC filters (Cat. No. 225-803) completely.

Δ 1.0-micron PTFE filter is a NIOSH recommended substitute filter for the 0.8-micron PVC filter originally recommended in NIOSH Method 7904.

Σ Use an oxidizer tube if sulfur dioxide is present.

+ Sonic flow

○ Use sorbent tube Cat. No. 226-120 when sampling in atmospheres containing ozone.

†† Special order/limited shelf-life; contact SKC

▼ The MOPIP Derivatizing Solution, Cat. No. 225-9050, is needed to analyze for monomer/oligomer aerosol.

Ω For sampling in Chromium plating operations, PVC filters (225-802) require special treatment after receipt at the laboratory. Alternatively quartz fiber filters (225-1827) treated with NaOH may be used. Refer to the method for details.

● NIOSH Method 5524 analysis requires a Filter Funnel which is available from Case Custom Environmental Equipment, Erlanger, KY, Telephone 859-250-8558.

£ Collect six samples at 20 minutes each. Use two Cat. No. 226-134 per sample.

Collecting Equipment

AC	Accu-CAP Cassette Insert
BI	Bioaerosol Impactor
BS	BioSampler
C	Capsule
C/HLD	Filter Cassette and Cyclone Holder
CAN	Canister
CF/CST	Coated Filter in Preloaded Cassette
CH	Capsule Holder
CI	Cascade Impactor
CPC	Constant Pressure Controller
CST	Filter Cassette
CYC	Cyclone
DR	Direct-reading
DRI	Direct-reading Instrument
DRT	Drying Tube
DT	Detector Tube, Color
EPAM	Environmental Particulate Monitor
F/CST	Filter in Preloaded Cassette
FLT	Filter
FLT/CL	Filter Cassette with Cowl
FOAM	Foam
IMP	Impinger
IOM	IOM Particulate Sampler
IS	Impaction Substrate
IT	Impinger Trap
JAR	Jar
MVC	Microvacuum Cassette
PK	Passive Kit
PPI	Parallel Particle Impactor
PS	Passive Sampler
PUF	PUF Cartridge
SB	Sample Bag
SCN	Screen
SCRN	Stainless Steel Screen
SH	Sampling Head
SM TB	Smear Tab
SP	Support Pads
SPC	Spacer
SSC	Stainless Steel Cassette
ST	Sorbent Tube
STC	Spore Trap Cassette
SV	Sorbent Vial
T	Tape
TH	Tube Holder
TK	Test Kit
TMP	Template
VAC	Vac-U-Chamber
VT	ViaTrap for use with BioSampler
W	Wipe

AA	Atomic absorption
AAS	Atomic absorption spectroscopy
AED	Atomic emission detection
AES	Atomic emission spectroscopy
CA	Chromotropic acid assay
CD	Conductivity detection
CI	Colorimetric
CLR	Spectrophotometric method or colorimeter
DET TB	Detector tube, color-indicating
DID	Discharge ionization detector
DPCSP	Differential pulse cathodic stripping polarography
DPP	Differential pulse polarography
DR	Direct-reading
DRI	Direct-reading instrument
EAP	Explosives analysis package
ECD	Electron capture detector
ECN	Electrolytic conductivity detector
EGA-TOS	Evolved gas analysis with thermal-optical sensor
ELCHM	Electrochemical detector
F	Flame
FAME	Fatty acid methyl ester
FD	Fluorescence detector
FID	Flame ionization detector
FLAG	Flame arsine generation
FLUOR	Fluorescence
FPD	Flame photometric detector
FPDS	Flame photometric detector sulfur specific
GC	Gas chromatography
GF	Graphite furnace
GR	Gravimetric analysis
HGA	Heated graphite atomizer
HPLC	High-performance liquid chromatography
HRGC	High resolution gas chromatography
HRMS	High resolution mass spectrometry
IC	Ion chromatography
IC-CD	Ion chromatography detector
ICP	Inductively coupled plasma
ICP-DCP	Inductively coupled plasma- directly coupled plasma spectroscopy
IR	Infrared spectrophotometry
IRA	Immunoradiometric assay
ISE	Ion-specific electrode
MAS	Molecular absorption spectrometry
MD	Multi-detector
MS	Mass spectrometry
MSD	Mass selective detector
N ACT	Neutron activation

Abbreviations

Analytical Methods

NCD	Nitrogen chemiluminescence detector
NPD	Nitrogen-phosphorus detector
NSD	Nitrogen-specific detector
NVM	No validated method
P FLUOR	Portable fluorescence
P GC	Portable gas chromatography
P IR	Portable infrared spectro- photometry
P IS	Portable infrared spectrophotometer
P VAS	Portable visible absorption spectrophotometry
PASV	Portable anodic stripping voltammetry
PCD	Post-column derivatization
PCM	Phase contrast microscopy
PCR	Polymerase chain-reaction
PDA	Photo diode array detector
PES	Plasma emission spectrometry
PID	Photoionization detector
PLM	Polarized light microscopy
POL	Polarography
SCD	Sulfur chemiluminescence detector
SEM	Scanning electron microscopy
SPOT	Chemical spot test
TCD	Thermal conductivity detector
TD	Thermal desorption
TEA	Thermal energy analyzer
TEM	Transmission electron microscopy
TITRA	Titration
TOA	Thermal-optical analysis
UV	Ultraviolet detector
VAS	Visible absorption spectrophotometry
VIS	Visual
W	Wipe
XRD	X-ray diffraction
XRF	X-ray fluorescence
XRFS	X-ray fluorescence spectroscopy



References

SKC Sampling Guides are abstracted from publications by the National Institute of Occupational Safety and Health (NIOSH), the Occupational Safety and Health Administration (OSHA), American Society for Testing and Materials (ASTM) International, the Environmental Protection Agency (EPA), Health and Safety Executive (HSE), and published non-agency methods.

NIOSH, OSHA, EPA, HSE, and ASTM International Agency References

NIOSH Manual of Analytical Methods, Fifth Edition, 2016

OSHA Analytical Methods Manual, published 1985 with updates through 1994; method number only for organics, method number with ID prefix for inorganics

OSHA Chemical Sampling Information (CSI) on the OSHA website, previously the OSHA Chemical Information Manual (CIM), a resource for on-site sampling used by OSHA compliance officers. Chemical entries are listed alphabetically. Go to www.osha.gov and search on "chemical sampling information."

EPA Compendium of Methods, Toxic Organic (TO) Jan. 1997, Inorganic (IO) Feb. 1997, Indoor Air (IP) Apr. 1990

Methods for Determination of Hazardous Substances (MDHS) is a series published by Health and Safety Executive (HSE) Books in the U.K. that describes procedures for the measurement of personal exposure to contaminants in air. Go to www.hse.gov.uk/pubns/mdhs/.

ASTM International, Annual Book of Standards, Section 11 - Water and Environmental Technology, Volume 11.03. Occupational Health & Safety; Protective Clothing

Non-agency References

10. **Acrylic Acid**; proprietary method, contact SKC for procedure
11. **Nitrogen Dioxide and Nitric Oxide**; *Am. Ind. Hyg. Assoc. J.*, Vol. 38 (1977), pp. 358-363
14. **Ethylene Oxide**; *Am. Ind. Hyg. Assoc. J.*, Vol. 38 (1977), pp. 635-647
16. **Iodine**; *Am. Ind. Hyg. Assoc. J.*, Vol. 42 (1981), pp. 187-190
17. **Mercury**; *Am. Ind. Hyg. Assoc. J.*, Vol. 37 (1976), pp. 311-314
19. **Nicotine**; *Jrnl. of the Assoc. of Analytical Chemists*, Vol. 72 (1989), No. 6, pp. 1002-1006
21. **Vinyl Acetate**; *Am. Ind. Hyg. Assoc. J.*, Vol. 43 (1982), pp. 137-142
22. **Hydrazine**; *Am. Ind. Hyg. Assoc. J.*, Vol. 41 (1980), pp. 879-900
25. **Hydrazoic Acid**; *Am. Ind. Hyg. Assoc. J.*, Vol. 52 (1991), pp. 14-19
26. **4,4'-Bipyridine Vapor**; *Am. Ind. Hyg. Assoc. J.*, Vol. 54 (1993), pp. 440-445
28. **Methyltetrahydrophthalic Anhydride**; *Ann. Occup. Hyg.*, Vol. 36 (1992), pp. 189-197
29. **Chloromethyl Methyl Ether**; *Am. Ind. Hyg. Assoc. J.*, Vol. 42 (1981), pp. 47-55
38. **Nonpolar Organic Compounds**; *Analytical Chem.*, Vol. 63 (July 1, 1991) No. 13, pp. 1228-1232
39. **Multifunctional Acrylates**; *Appl. Occup. Environ. Hyg.*, Vol. 9 (Dec. 1994), pp. 977-983
40. **Chloroformates and Phosgene**; *Am. Ind. Hyg. Assoc. J.*, Vol. 47 (Dec. 1986), pp. 742-746
41. **Ammonia**; *Union Carbide Health, Safety, and Environ. Tech.*, S. Charleston, WV, Method 38C-1P7-TSSc, pub. 1992
42. **Sulfur Gas**; *NCASI Technical Bulletin 656*, Dec. 1993
43. **Glutaraldehyde**; *Union Carbide 38C-4Q5-TSGE*, Dec. 1997
44. **2,3-Dimethyl-2,3-Dinitrobutane Vapor**; *Am. Ind. Hyg. Assoc. J.*, Vol. 59 (1998), pp. 388-392
46. **Oil Mist Aerosol**; *Am. Ind. Hyg. Assoc. J.*, Vol. 57 (Dec. 1996), pp. 1149-1152
48. **Bioaerosols**; *Field Guide for the Determination of Biological Contaminants in Environmental Samples*, AIHA Publications, Fairfax, VA, 1996
49. **Environmental Tobacco Smoke (Nicotine and 3-Ethenylpyridine)**; Ogden, M. W., et al., a compilation of published articles on detection of alkaloids in ETS, nicotine in ETS, and a comparative evaluation of diffusive and active sampling systems for airborne nicotine and 3-EP, 1992-1999
50. **2,2-Dichloro-1,1,1-Trifluoroethane**; *Am. Ind. Hyg. Assoc. J.*, Vol. 63 (Nov./Dec. 2002), pp. 715-720
51. **Trichloronitromethane**; *CA Air Resources Board*, Oct. 2002
52. **Hexamethylenetetramine**; *Ontario Ministry of Labour Method, AIHce 2005*
53. **Lactose Powder**; pharmaceutical industry method
54. **Acrylates, Acrylonitriles, and Styrene**; Saunders, H., Methyl Acrylate, Acrylonitrile, Ethyl Acrylate, n-Butyl Acrylate, Methyl Methacrylate, n-Butyl Methacrylate, and Styrene Using Anasorb 747 Sorbent Tubes, Rohm and Haas Corporate Industrial Hygiene Laboratory, Method IH9402
55. **Kathon 886 Biocide (2-Methyl-4-isothiazolin-3-one and 5-Chloro-2-methyl-4-isothiazolin-3-one)**; Sobczak, S.S., Rohm and Haas Corporate Industrial Hygiene Laboratory, Method IH9901, 2001
56. **Radon Progeny (on dust, in mines)**; U.S. Dept. of Labor, Mine Safety and Health Administration, MSHA Handbook No. PH06-IV-1(1) Metal and Non-metal Mine Safety and Health MSHA Handbook Series, Oct. 2006
57. **Peroxyacetic Acid/Hydrogen Peroxide**; *Ann. Occup. Hyg.*, Vol. 48, No. 8 (2004), pp. 715-721
58. **Manganese Fume**; *Ann. Occup. Hyg.*, Vol. 53, No. 2 (2009), pp. 99-116



Tech Tips

- ▶ Access online SKC Sampling Guides for the most up-to-date sampling information. Visit www.skcinc.com and click on Sampling Guides on the left side navigation bar.
- ▶ Get fast access to agency and organization websites from www.skcinc.com by clicking Links on the left side navigation bar.

Air Sampling Terms

8-Hour Time-weighted Average (TWA)

The average full-shift exposure level calculated by weighting concentrations throughout a workday with respect to time. The denominator "eight hours" is used because OSHA standards are based on an 8-hour workday. OSHA and ACGIH use the following formula to calculate TWA:

$$TWA = \frac{C1T1 + C2T2 + C3T3 \dots CnTn}{8 \text{ hrs}}$$

TWA = Time-weighted average concentrations in ppm or mg/m³

C = Concentration of contaminant during an incremental exposure time

T = Time — incremental exposure time

Absorption

The penetration of airborne chemicals into a collection medium, such as impinger fluid, where the chemicals will dissolve or react chemically

Active Sampling

The collection of airborne contaminants by means of a forced movement of air by a sample pump through appropriate collection media

Adsorption

The collection of gases and vapors onto the surface of a collection medium such as the sorbent material in sorbent tubes

Aerodynamic Diameter

A description of the shapes and densities of dust particles; the diameter of a unit-density sphere having the same settling velocity as the particle in question

Aerosol

Microscopic liquid or solid particles dispersed into the air

Air Volume

The total amount of air passed through a sampling medium; determined by multiplying flow rate in ml/min or L/min by the sample time in minutes

Ambient Air

Air that is external to buildings and accessible to the general public

Back Pressure

The pressure drop, i.e., resistance to flow created by the collected sample or the sample media itself

Bioaerosols

Airborne particles, molecules, or volatile compounds ranging in size from 100 microns to 0.01 micron that are living, contain living organisms, or were released from living organisms

Blank Sample

A representative sampling medium sent as a control with the actual sample to a lab. Blanks are subjected to the same procedures as samples, except no air is drawn through them.

Ceiling Value

The concentration that should not be exceeded during any part of the work day

Closed-face Sampling

Filter sampling using a two or three-piece cassette with the cassette inlet section in place and the sealing plugs removed

Constant Flow

A feature available on air sample pumps that allows the pump to automatically compensate for flow restrictions and variations, ensuring the flow rate is held constant throughout the sampling period

50% Cut-point

Describes the performance of cyclones and other particle size-selective devices. For personal sampling, the 50% cut-point is the size of the dust that the device collects with 50% efficiency.

Cyclone

A sampling device used to collect and separate respirable particulate mass. The cyclone functions as a centrifuge; the rapid circulation of air separates particles according to size.



Desorption Efficiency

A measure of how much analyte can be recovered from the sorbent tube

Dust

Solid particles rendered airborne during the crushing or grinding of hard, rock-like materials

Fugitive Emissions

Emissions that could not reasonably pass through a stack, chimney, vent, or other functionally equivalent opening

Fume

Solid airborne particles formed by the vaporization of solid materials, oxidation of the vapor, and condensation of the oxide

Gas

A state of matter consisting of molecules in constant random motion that is neither a defined volume nor shape and remains in this state at normal temperature (25 C) and pressure (1 atmosphere)

Grab Sampling

The direct collection of an air-contaminant mixture into a device such as a sample bag or detector tube over a brief period



Gravimetric Analysis

Sample analysis of filters by determining sample weight

High Flow Sampling

The collection of airborne contaminants (typically particulates) at flow rates greater than 1000 ml/min

Indoor Environmental Quality

The impacts of the indoor environment, including but not limited to air quality, lighting, and thermal comfort, on occupant health, comfort, and performance

Integrated Sampling

The collection of air contaminants over an extended period

LEED

Leadership in Energy and Environmental Design (LEED) is a program that provides building owners/operators with a framework for identifying and implementing practical and measurable green building design, construction, operation, and maintenance solutions.

Low Flow Sampling

The sampling of airborne contaminants (typically gases and vapors) at flow rates less than 500 ml/min

Matched-weight Filters

Two filters that match in weight; the top filter collects contaminants, the bottom filter serves as a control. After sampling, both filters are weighed and the difference between weights is the sample weight.

Mist

Droplets rendered airborne by rubbing, boiling, splashing, or otherwise agitating a liquid

Nanoparticle

Intentionally manufactured particles with at least one dimension in the range of 1 to 100 nanometers (nm)

Near-roadway Monitoring

An EPA network of monitors established near major roadways to monitor/assess NO₂ mobile source emissions from vehicles in areas where people live, work, play, attend school, and commute. The network also provides the ability to collocate monitors to assess mobile contribution to particulate matter (PM₁₀, 2.5, and ultrafine) exposure.

Air Sampling Terms

Open-face Sampling

Filter sampling using a three-piece cassette with the cassette inlet section removed; this is typically used for sampling asbestos and other fibers

Particulate Matter (PM)

A mix of solid particles and liquid droplets suspended in air. Origin, shape, size, and composition vary. Standards exist for PM₁₀ (diameter $\leq 10 \mu\text{m}$) and PM_{2.5} (diameter $\leq 2.5 \mu\text{m}$) because they are easily trapped in the lungs and are most likely to cause adverse health effects. Additional particles of concern are PM_{1.0} (diameter $\leq 1 \mu\text{m}$) and PM Coarse (diameter $< 10 \mu\text{m}$ and $> 2.5 \mu\text{m}$).

Passive (Diffusive) Samplers

Small air samplers or “badges” that collect airborne gases or vapors without the use of a pump. Chemicals diffuse through a diffusion barrier onto a sorbing medium inside the sampler at a fixed rate that can be scientifically determined.



Preloaded Filter Cassettes

Ready-to-use cassettes that comprise a cassette, filter, support pad, and sealing plugs

Preweighed Filters

Individual filters that are weighed to within 5 decimals before they are loaded into a cassette

Sampling Parameters — Rate, Time, and Volume

Consult specific methods to determine the range given for each parameter. In the SKC Sampling Guide under “Sampling,” some chemicals have two different recommendations for sampling rates and times; the sampling rate for an 8-hour sample is listed with the shorter period rate in parentheses. The choice of rate depends on sampling requirements.

Sampling Train

The entire sampling system: sampling medium (sorber tube, filter, cyclone, IOM, etc.) connected to a sample pump with flexible tubing

Short-term Exposure Limit (STEL)

A 15-minute time-weighted average exposure that should not be exceeded during any part of the workday

Smoke

Particles resulting from the incomplete combustion of organic matter and consisting predominantly of carbons and oxides of carbon

Solvent Desorption

The process of extracting adsorbed chemicals from sorbent material through the use of solvents

Source Emissions

Particulate or gaseous emissions generated from a stationary source, such as a stack

Thermal Desorption

The process of extracting adsorbed chemicals from sorbent material through the use of heat

TLV-TWA

An ACGIH-defined concentration level in air, typically for inhalation or skin exposure, to which it is believed a worker can be exposed day after day (8 hours per day, 40 hours per work week) for a working lifetime without adverse health effects

Traditional Workplace Exposure Guidelines

- **Total Dust**
Dust that is collected using closed-face 37-mm cassettes fitted with suitable filters
- **Respirable Dust**
Particles that penetrate to the gas exchange regions of the lung; collected using a filter cassette with suitable filter and a cyclone

Ultrafine Particulate Matter

Ultrafine particles less than 100 nanometers (0.1 micron) result from combustion, friction, or natural processes in the air or water. While nano-sized, ultrafine particles are not nanoparticles because they are neither intentionally manufactured nor of a constant composition or size.

Updated Workplace Exposure Guidelines

The concept of size-selective sampling of industrial aerosol is based on the measurement of particles associated with a specific human health effect, i.e., how deeply particles penetrate into the respiratory tract. ACGIH recommends that particle size-selective threshold limit values (TLVs) be expressed in three forms:

- **Inhalable Particulate Mass** (100- μm 50% cut-point), hazardous when deposited anywhere in the respiratory tract
- **Thoracic Particulate Mass** (10- μm 50% cut-point), hazardous when deposited anywhere in the lung airways and the gas exchange regions
- **Respirable Particulate Mass** (4- μm 50% cut-point), hazardous when deposited in the gas exchange regions of the lungs

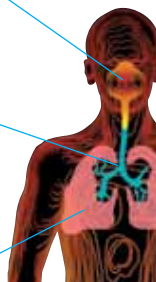

SKC Trademarks

Accu-CAP	Leland Legacy
AirChek	MethChek
AirLite	Pocket Pump
Anasorb	PowerFlex
BestChek	QuickTake
BioSampler	SamplePro
BioStage	SKC
CalChek	Solu-CAP
Chek-mate	SPLIT2
DataTrac	ULTRA
FlexFoil	VersaTrap
Full Disclosure	ViaTrap
ISO-CHEK	VOC Chek

Other Trademarks

ACGIH: ACGIH, BEI, TLV
Adobe Syst. Inc.: Acrobat Reader
AMVAC Chemical Corp.: Thimet
Bayer: Co-Ral
Bayer CropScience, Inc.: Baygon, Sevin, Temik
Boehringer Ingelheim International GMBH Corp.: Alupent
Buchem B.V. Corp.: Tenax
Carus Corp.: Carulite
Celite Corp.: Chromosorb
Dow AgroSciences LLC: Dursban, Tordon
DuPont: Freon, Tedlar, Vydate, Delrin, Viton, DuPont
Duraname Corp.: Duracell
Eveready Battery Co., Inc.: Energizer
Gowan Co., LLC: Betasan
LinkedIn Corp.: LinkedIn
Microsoft: Microsoft, PowerPoint, Windows, Excel
Millipore Corp.: Swinnex
Monsanto Chemical Co.: Ramrod, Roundup
Norton Co.: Tygon
Occidental Chem.: OXSOL
Pelican Products, Inc.: Pelican
Rayovac Corp.: Rayovac
Rohm & Haas: XAD, Kathon
Shell Chemical Co.: Azodrin
Shell Oil Co.: Bladex, Rabon
Swagelok Company Corp.: Swagelok
Thermo Environmental Instruments Inc.: TEOM
3M Co.: LeadCheck, Red Means Lead
U. S. Green Building Council: LEED
Union Carbide Corp.: CELLOSOLVE, Tergitol
W. A. Hammond Drierite Co., LTD: Drierite
Waters Associates, Inc.: Porapak
Yorick, Inc.: Botran

A

Accu-CAP	92
Adapters, Tubing	35, 50-51, 104
Air Sampling Guide	143-213
AirChek 3000	20-21
AirChek 52/Sidekick	18-19
AirChek TOUCH	8-10
AirChek XR5000	14-15
AirLite	29
AIR-AIDE	132
All-in-One	50
Aluminum Cyclone	111
Ambient Air Quality Monitor	134-135
Analysis Accessories	104-105
Area Pumps	22-29, 123
Asbestos Sampling	26-29, 90
ASTM Methods	156-211

B

Badges	
Aldehydes	84
Ammonia	85
Formaldehyde	84
Health Care Industry	83
Hydrogen Cyanide	86
Mercury	86
Nitrogen Dioxide	85
Organic Vapor	68-82
Sulfur Dioxide	85
ULTRA	72-73
UMEX	84-85
VOCs	74-82
VOC Chek	74-75
Bags, Sample	52-59
Battery Chargers	30-31
Bioaerosol Filters	100, 119
Bioaerosol Guide	118
Bioaerosol Samplers	118-125
Bioaerosol Tape	124
BioLite	123
BioSampler	122-123
BioStage	120-121
Breath Bags	54-57
Bubble Meters	
(Pump Calibrators)	34
Bubblers (Impingers)	67
Button Sampler	109, 119

C

CalChek Cable	21
Calibration Jars	104
Calibrators	32-34
Carpet Sampling	124, 142
Cases, Pump	35
Cassette Blanks	97
Cellulose Filters	96
Chargers, Battery	30-31
Charging Cradle	10, 30
chek-mate	32-33
Coated Filters	98-99
Constant Pressure Controller	51
Cyclones	110-111

D

DataTrac Software	11
DCS	24-25
Deployable Systems	24-25
Diesel Particulate Matter	95
Diffusive Samplers	68-86
Digestible Filter Capsules	89
DPM Cassettes	95
DPS System	24-25
Drying Tubes	39

Dust Samplers

Button	109, 119
Cyclones	110-111
HAZ-DUST	130-131
IMPACT	116
IOM	108
PEM	114
PMI	115
PPI	112-113
Sioutas	117
SPLIT2	127

E

e-Cradle	10
EPA Methods	156-211
EPAM-5000	128
EPAM-7500	129
EPAS	134-135
Ethylene Oxide Sampler	83
Exhaled Breath Bags	54-57

F

Film Calibrators	34
Filter Cassettes	
Asbestos	90
Coated	64-66, 98-99
Matched-weight	88, 93
Microvacuum	124, 142
Preweighed	93
Solu-CAP	89
Filters and Accessories	87-105
FlexFilm Bags	58
FlexFoil Bags	56-57
Flite 3	28
Flowmeters	32-34
Foil Bags	56-57
Formaldehyde Monitor	136
Full Disclosure	139

G

Gelatin Filters	100, 119
Ghost Wipes	140
Glass Fiber Filters	96
Grab Air Pump	60
GS Cyclones	110
Guides	
Air Sampling	156-213
Bioaerosol	118
HSE	144-155
Particle Size-selective	106-107
Personal Pumps	5

H

HAZ-DUST	130-131
HAZ-SCANNER	133-135
Health Care Industry Badges	83
Helmet Adapter	104
High Flow Pumps	22-29

Holders

Filter Cassette	102
Impinger	67
Sample Tube	50-51
HSE Guide	144-155

I

IAQ Pumps	26-27
IAQ/IEQ Monitors	128-133
IEMS	133
IMPACT Sampler	116
Impactor, BioStage	120
Impactor, Sioutas	117
Impingers and Accessories	67
Inhalable Dust Samplers	108-109
IOM Sampler	108
ISO-CHEK	66, 99

L

Lead Sampling	138-140
Leland Legacy	22-23
Low Flow Adapters	50-51
Low Flow Pumps	12-13, 61
Luer Adapters	35, 104

M

MCE Filters	88-90
Mercury Badges	86
Meth Detection Kit	141
Microvacuum Cassettes	124, 142

Monitors

Dust	130-131
Formaldehyde	136
HAZ-DUST	130-131
IAQ/IEQ	128-133
Multiple Tube Holders	51

N

Nano-Neat	88
NIOSH Methods	156-211

O

Organic Vapor Badges	68-82
OSHA Methods	156-211
OVS Tubes	43

P

PAA Sampling	42
Particle Size-selective Guide	106-107
Particulate Monitors	
DPS	24-25
EPAM-5000	128
EPAM-7500	129
HAZ-DUST	130-131
SPLIT2	127

Passive Samplers	68-86
Peracetic Acid Sampling	42
PEM	114
Personal Pumps	8-23, 29
PFA Impingers	67
PM2.5 Samplers	114-116
PM10 Samplers	114-116
PM Coarse Samplers	115-116
PMI	115
Pocket Pump TOUCH	12-13, 61
Polycarbonate Filters	91
PowerFlex Chargers	30-31
PPI	112-113
PTFE Filters	94
PUF Tubes	44-45
Pump Cases	35
Pump Pouches	35

Pumps

5 to 3000 ml/min	18-21, 29
5 to 3250 ml/min	20-21
5 to 5000 ml/min	8-10, 14-17
5 to 15 L/min	22-23
10 to 30 L/min	26-27
20 to 500 ml/min	12-13, 61
AirChek 52/Sidekick	18-19
AirChek TOUCH	8-10
AirLite	29
Flite 3	28
Grab Air	60
Leland Legacy	22-23
Pocket Pump TOUCH	12-13
QuickTake 30	26-27
Sonic Flow	123
Universal	16-17
XR5000	14-15
PVC Filters	93

Q

Quartz Filters	95
QuickTake 30	26-27

R

Respirable Samplers	110-113
Rotameters	34

S

Sample Bags	52-59
Sample Tubes	
Passive	48-49
Sorbent	36-45
Thermal Desorption	47-49
SamplePro FlexFilm	58

Samplers

Area	22-29, 123
Passive (Diffusive)	48-49, 68-86
Personal	8-23, 29
Sampling Guide	156-213
Shrink Bands, Cassette	103
Silver Membrane Filters	91
Sioutas Impactor	117
Soap Solution	34

Software

DataTrac	11
Solu-CAP	89
Sonic Flow Sampler	123
Sorbent Sample Tubes	36-49
SPLIT2	127
Spore Traps	101, 125
Sterile Swabs	124, 142
Stick-to-it	124, 142
Support Pads, Filter	103
Surface Sampling, Biological	124, 142
Surface Sampling, Chemical	139-142

T

Take Charge 5	15, 23, 31
Tedlar Sample Bags	54-55
Thermal Desorption Tubes	47-49
Thoracic Samplers	112-113
TOUCH	8-13, 61
Trap, Impinger	67
Tube Breakers	42
Tube Covers	50-51
Tube Holders	50-51
Tubes	
OVS	43
PUF	44-45
Sorbent Sample	36-49
Thermal Desorption	47-49
VOST	47
Tubing	35
Tubing Adapters	35, 50-51, 104

U

ULTRA Passive Samplers	72-73
UMEX Passive Sampler	84-85
Universal Pumps	16-17

V

Vac-U-Chamber	62-63
Vac-U-Go	123
VersaTrap Spore Trap	101, 125
Vest, Sampling	105
ViaTrap	122
VOC Chek	74-75

VOCs

Badges	74-75
Bags	52-59
Tubes	38-49
VOST Tubes	47

W

Wipe Sample Kit	140
-----------------	-----

X

XR5000	14-15
--------	-------



SKC Inc.
 World Headquarters
 Eighty Four, PA
 800-752-8472

SKC South
 Appomattox, VA
 800-752-7684

SKC West
 Fullerton, CA
 800-752-9378

SKC Gulf Coast
 Houston, TX
 800-225-1309

SKC Ltd.
 Blandford Forum
 Dorset, U.K.
 www.skcltd.com

SKC South Africa (Pty) Ltd.
 Boksburg, South Africa
 www.skcsouthafrica.co.za

SKC Asia HSE Sampling
 Technologies Pte Ltd.
 www.skc-asia.com

www.skcin.com

f t in



SKC Global Catalog and Sampling Guide - 2016/2017



THE ESSENTIAL SOURCE FOR SAMPLING INSTRUMENTS AND MEDIA



2016/2017



The Global Source for Sampling Instruments and Media

SKC — quality products, technical support, and customer satisfaction

SKC Inc. — World Headquarters

863 Valley View Road
Elmly Four, PA 15330 U.S.A.
Phone: +1-724-941-9701
E-mail: skcorder@skcinc.com

SKC Ltd.

Unit 11, Sunrise Park
Higher Shaftesbury Road
Blandford Forum, Dorset DT11 8ST
United Kingdom
Phone: +44 (0)1258 480188
E-mail: info@skcld.com
Web: www.skcld.com

SKC South Africa (Pty) Ltd.

Unit 2, Wilfrid Centre
Cnr Kingfisher & Dulker Streets
Sunward Park, Boksburg, Gauteng
South Africa
Phone: +27 11 913 2666
E-mail: sales@skcsouthafrica.co.za
Web: www.skcsouthafrica.co.za

SKC Asia HSE Sampling Technologies Pte Ltd.

16 Jalan Klang Timor #07-08
Redhill Forum
Singapore 159308
Singapore
Phone: +65 6271 0291
E-mail: sales@skc-asia.com
Web: www.skc-asia.com

Visit www.skcinc.com and click on Customer Service to find the distributor in your area, call +1-724-941-9701, or contact your nearest branch for assistance with direct shipments.

Quickly and easily access SKC online product information in over 60 languages!



www.skcinc.com

SKC — Proud to be Green

SKC is an environmentally responsible company committed to the efficient use of natural resources and the reduction of manufacturing impact on the environment. SKC's green strategy includes:

- Using biodegradable packaging where possible
- Minimizing packaging, using toxic-free products/packaging, designing with less raw material, implementing energy savings, and buying environmentally friendly products
- Repairing, donating, or selling rather than discarding, buying recycled material packaging, using recycled paper/cover, and packaging with recycled materials
- Selecting vendors who sell/distribute products with recycled content and using approved recycling facilities for paper, plastic, cans, batteries, and chemicals

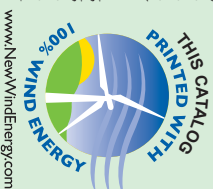

SKC — The Global Source

www.skcinc.com
www.skc-asia.com

www.skcld.com
www.skcsouthafrica.co.za